

MS2681A/MS2683A/MS2687A/MS2687B
Spectrum Analyzer
Operation Manual
Vol. 2
(Detailed Operating Instructions)

Ninth Edition

Read this manual before using the equipment.
Keep this manual with the equipment.

DEC.
2003

ANRITSU CORPORATION

Document No.: M-W1754AE-9.0

For Safety

WARNING



1. **ALWAYS** refer to the operation manual when working near locations at which the alert mark shown on the left is attached. If the operation, etc., is performed without heeding the advice in the operation manual, there is a risk of personal injury. In addition, the equipment performance may be reduced.

Moreover, this alert mark is sometimes used with other marks and descriptions indicating other dangers.

2. **Measurement Categories**

This instrument is designed for Measurement category I (CAT I). Don't use this instrument at the locations of measurement categories from CAT II to CAT IV.

In order to secure the safety of the user making measurements, IEC 61010 clarifies the range of use of instruments by classifying the location of measurement into measurement categories from I to IV.

The category outline is as follows:

Measurement category I (CAT I):

Secondary circuits of a device connected to an outlet via a power transformer etc.

Measurement category II (CAT II):

Primary circuits of a device with a power cord (portable tools, home appliance etc.) connected to an outlet.

Measurement category III (CAT III):

Primary circuits of a device (fixed equipment) to which power is directly supplied from the power distribution panel, and circuits from the distribution panel to outlets.

Measurement category IV (CAT IV):

All building service-line entrance circuits through the integrating wattmeter and primary circuit breaker (power distribution panel).



or



3. When supplying power to this equipment, connect the accessory 3-pin power cord to a grounded outlet. If a grounded outlet is not available, before supplying power to the equipment, use a conversion adapter and ground the green wire, or connect the frame ground on the rear panel of the equipment to ground. If power is supplied without grounding the equipment, there is a risk of receiving a severe or fatal electric shock.

For Safety

WARNING

Repair

WARNING

4. This equipment cannot be repaired by the user. DO NOT attempt to open the cabinet or to disassemble internal parts. Only Anritsu-trained service personnel or staff from your sales representative with a knowledge of electrical fire and shock hazards should service this equipment. There are high-voltage parts in this equipment presenting a risk of severe injury or fatal electric shock to untrained personnel. In addition, there is a risk of damage to precision parts.

Falling Over

5. This equipment should be used in the correct position. If the cabinet is turned on its side, etc., it will be unstable and may be damaged if it falls over as a result of receiving a slight mechanical shock.
And also DO NOT use this equipment in the position where the power switch operation is difficult.

Battery Fluid

6. DO NOT short the battery terminals and never attempt to disassemble it or dispose of it in a fire. If the battery is damaged by any of these actions, the battery fluid may leak.

This fluid is poisonous.

DO NOT touch it, ingest it, or get in your eyes. If it is accidentally ingested, spit it out immediately, rinse your mouth with water and seek medical help. If it enters your eyes accidentally, do not rub your eyes, irrigate them with clean running water and seek medical help. If the liquid gets on your skin or clothes, wash it off carefully and thoroughly.

LCD

7. This instrument uses a Liquid Crystal Display (LCD); DO NOT subject the instrument to excessive force or drop it. If the LCD is subjected to strong mechanical shock, it may break and liquid may leak.

This liquid is very caustic and poisonous.

DO NOT touch it, ingest it, or get in your eyes. If it is ingested accidentally, spit it out immediately, rinse your mouth with water and seek medical help. If it enters your eyes accidentally, do not rub your eyes, irrigate them with clean running water and seek medical help. If the liquid gets on your skin or clothes, wash it off carefully and thoroughly.

For Safety

CAUTION

Replacing Fuse

CAUTION 

1. Before Replacing the fuses, ALWAYS remove the power cord from the poweroutlet and replace the blown fuses. ALWAYS use new fuses of the type and rating specified on the fuse marking on the rear panel of the cabinet.

T6.3A indicates a time-lag fuse.

There is risk of receiving a fatal electric shock if the fuses are replaced with the power cord connected.

Cleaning

2. Keep the power supply and cooling fan free of dust.
 - Clean the power inlet regularly. If dust accumulates around the power pins, there is a risk of fire.
 - Keep the cooling fan clean so that the ventilation holes are not obstructed. If the ventilation is obstructed, the cabinet may overheat and catch fire.

Check Terminal



3. Maximum DC voltage ratings:
RF Input \pm DC 0 V
Maximum AC power (continuous wave) ratings:
RF Input +30 dBm (RF ATT \geq 10 dB)

NEVER input a over maximum ratings to RF Input, excessive power may damage the internal circuits.

- ◆ MS2681A/MS2683A (plus opt.08 pre-amplifier ON)
Maximum AC power (continuous wave) ratings:
RF Input +10 dBm (RF ATT \geq 10 dB)

NEVER input a over maximum ratings to RF Input, excessive power may damage the internal circuits.

For Safety

CAUTION

Replacing Memory Back-up Battery

The power for memory backup is supplied by a Poly-carbonmonofluoride Lithium Battery. This battery should only be replaced by a battery of the same type; since replacement can only be made by Anritsu, contact the nearest Anritsu representative when replacement is required.

Note: The battery used in this equipment has a maximum useful life of 7 years. It should be replaced before this period has elapsed.

External Storage Media

This equipment stores data and programs using Plug-in Memory card. Data and programs may be lost due to improper use or failure. ANRITSU therefore recommends that you backup the memory.

Anritsu Corporation will not accept liability for lost data.

Pay careful attention to the following points.

- Do not remove the memory card from equipment being accessed.
- Isolate the card from static electricity.
- The PC-ATA Flash card operation is not guaranteed generally.

Disposing of The Product

This equipment uses chemical compound semiconductor including arsenide.

At the end of its life, the equipment should be recycled or disposed properly according to the local disposal regulations.

Equipment Certificate

Anritsu Corporation certifies that this equipment was tested before shipment using calibrated measuring instruments with direct traceability to public testing organizations recognized by national research laboratories including the National Institute of Advanced Industrial Science and Technology, and the Communications Research Laboratory, and was found to meet the published specifications.

Anritsu Warranty

Anritsu Corporation will repair this equipment free-of-charge if a malfunction occurs within 1 year after shipment due to a manufacturing fault, provided that this warranty is rendered void under any or all of the following conditions.

- The fault is outside the scope of the warranty conditions described in the operation manual.
- The fault is due to mishandling, misuse, or unauthorized modification or repair of the equipment by the customer.
- The fault is due to severe usage clearly exceeding normal usage.
- The fault is due to improper or insufficient maintenance by the customer.
- The fault is due to natural disaster including fire, flooding, earthquake, etc.
- The fault is due to use of non-specified peripheral equipment, peripheral parts, consumables, etc.
- The fault is due to use of a non-specified power supply or in a non-specified installation location.

In addition, this warranty is valid only for the original equipment purchaser. It is not transferable if the equipment is resold.

Anritsu Corporation will not accept liability for equipment faults due to unforeseen and unusual circumstances, nor for faults due to mishandling by the customer.

Anritsu Corporation Contact

If this equipment develops a fault, contact Anritsu Service and Sales offices at the address at the end of paper-edition manual or the separate file of CD-edition manual.

Notes On Export Management

This product and its manuals may require an Export License/Approval by the Government of the product's country of origin for re-export from your country.

Before re-exporting the product or manuals, please contact us to confirm whether they are export-controlled items or not.

When you dispose of export-controlled items, the products/manuals are needed to be broken/shredded so as not to be unlawfully used for military purpose.

Trademark and Registered Trademark

Windows is a registered trademark of Microsoft Corporation in the United States and/or other countries.

Front Panel Power Switch

To prevent malfunction caused by accidental touching, the front power switch of this equipment turns on the power if it is pressed continuously for about one second in the standby state. If the switch is pressed continuously for one second in the power-on state, the equipment enters the standby state.

In the power-on state, if the power plug is removed from the outlet, then reinserted into it, the power will not be turned on. Also, if the lines is disconnected due to momentary power supply interruption or power failure, the power will not be turned on (enters the standby state) even if the line is recovered.

This is because this equipment enters the standby state and prevents incorrect data from being acquired when the line has to be disconnected and reconnected.

For example, if the sweep time is 1,000 seconds and data acquisition requires a long time, momentary power supply interruption (power failure) might occur during measurement and the line could be recovered automatically to power-on. In such a case, the equipment may mistake incorrect data for correct data without recognizing the momentary power supply interruption.

If this equipment enters the standby state due to momentary power supply interruption or power failure, check the state of the measuring system and press the front power switch to restore power to this equipment.

Further, if this equipment is built into a system and the system power has to be disconnected then reconnected, the power for this equipment must also be restored by pressing the front power switch.

Consequently, if this equipment is built into remote monitoring systems that use MODEMs, please install option 46 "Auto Power Recovery" to equipment.

ABOUT DETECTION MODE

This instrument is a spectrum analyzer which uses a digital storage system. The spectrum analyzer makes level measurements in frequency steps obtained by dividing the frequency span by the number of measurement data points (501 or 1001). This method of measurement cannot detect the signal peak level if the spectrum of a received signal is narrower than these frequency steps.

To resolve this problem, this instrument usually operates in positive peak detection mode and normal detection mode. In the positive peak detection mode, the highest level within the frequency range between the sample points can be held and traced. In the normal detection mode, both the positive peak and the negative peak can be traced.

Positive peak detection mode should be used for almost all measurements including normal signal level measurement, pulsed noise analysis, and others. It is impossible to measure the signal level accurately in sample detection mode or in negative peak detection mode.

Use of sample detection mode is restricted to random noise measurement, occupied frequency bandwidth measurement for analog communication systems, and adjacent-channel leakage power measurement, etc.

Measurement	Item
• Normal signal	POS PEAK
• Random noise	SAMPLE
• Pulsed noise	NORMAL (POSI-NEG)
• Occupied frequency bandwidth, adjacent-channel leakage power	SAMPLE
(for analog communication systems)	
• Occupied frequency bandwidth, adjacent-channel leakage power	POS PEAK or SAMPLE
(for digital communication systems)	

When a detection mode is specified as one of the measurement methods, make the measurement in the specified detection mode.

About This Manual

(1) Composition of MS2681A/MS2683A/MS2687A/MS2687B Spectrum Analyzer Operation Manuals

The MS2681A/MS2683A/MS2687A/MS2687B Spectrum Analyzer operation manuals of the standard type are composed of the following three documents. Use them properly according to the usage purpose.

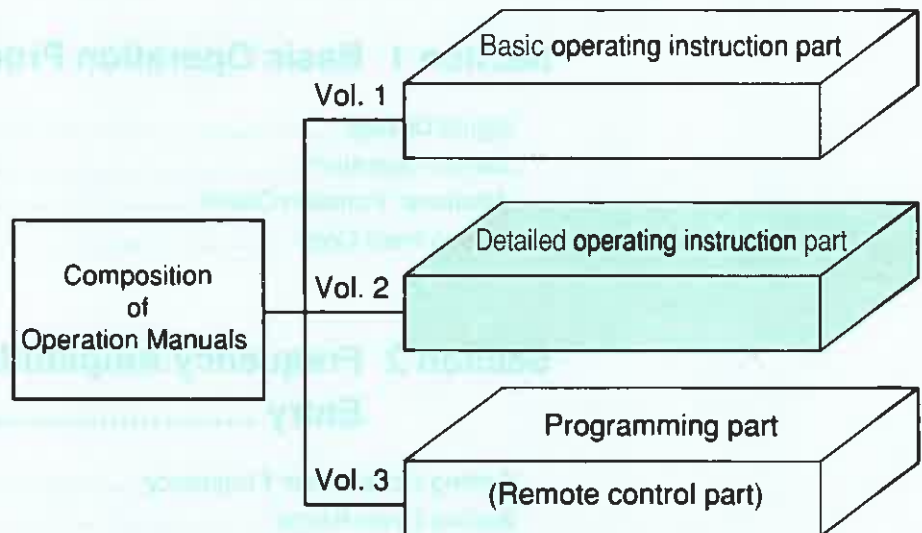

Basic operating instruction part:

Provides information on the MS2681A/MS2683A/MS2687A/MS2687B outline, preparation before use, panel description, basic operation, soft-key menu and performance tests.

Detailed operating instruction part:

Provides information on the detailed panel operating instructions on MS2681A/MS2683A/MS2687A/MS2687B that expand on the basic operation and soft-key menu in the Basic Operating Instruction Part.

Programming part (Remote control part):

Provides information on RS-232C remote control, GPIB remote control and sample programs.

Table of Contents

For Safety	iii
About This Manual	I
Section 1 Basic Operation Procedure	1-1
Signal Display	1-3
Marker Operation	1-6
“Measure” Function Check	1-8
Screen Hard Copy	1-10
Section 2 Frequency/Amplitude Data Entry	2-1
Setting Observation Frequency	2-3
Setting Level Range	2-16
Section 3 Marker Functions	3-1
Changing Zone Marker Position and Width	3-4
Marker Mode	3-7
Display Line	3-10
Zone Sweep and Signal Tracking	3-11
Multimarker	3-13
Marker Search	3-18
Setting Parameters Using Marker Values	3-23
Section 4 Signal Search Function	4-1
Detecting Peaks	4-3
Moving the Measurement Point	4-5
Section 5 Selecting the Display Method	5-1
Display Mode	5-3
Storage Mode	5-15
Detection Mode	5-22
Time Domain	5-26

Section 6	Selecting the Sweep Method	6-1
	Sweep Mode	6-3
	Trigger Mode	6-5
	Zone Sweep and Signal Tracking	6-12
	Time Gate Function	6-14
Section 7	Coupled Function	7-1
	From Auto to Manual Operation	7-4
	Coupled Function Common/Independent Setting Mode	7-12
Section 8	Automatic Calibration and Level Correction Function	8-1
	Automatic Calibration Function CAL ...	8-3
	Preselector tuning	8-6
	Measurement System Level Correction	8-7
Section 9	System Setting	9-1
Section 10	Save/Recall Function	10-1
	Internal Register	10-4
Section 11	Copy	11-1
	Direct Plotting	11-3
	Saving Screen Image Data to Memory Card	11-7
	Entering a Title	11-9
Section 12	Measurement	12-1
	Measure Measurement Function	12-3
	Measurement Examples	12-9

Section 13 Measurement of Field Strength 13-1

Field Strength Measurement 13-3
User Antenna Factor Setting, Save/Local to /from
a Memory Card 13-6
Caution: When Performing Field Strength Automatic
Measurement 13-7

Section 14 External Mixer 14-1

External Mixer Function 14-3

Section 15 MS2687A-21/MS2687B-21

Power Meter Function 15-1

MS2687A-21/MS2687B-21 Power Meter Function 15-3

Section 16 Measurement Software 16-1

Measurement Software 16-3
Installing Measurement Software 16-4
Installing Core Module Software 16-6
Displaying Maintenance Parameter Information 16-8
Registering Installation Key 16-13

Appendix A Soft-Key Menu A-1

Soft-key Menu List A-4
Spectrum mode Menu Tree A-6
Config mode Menu Tree A-30

Appendix B Keywords Index B-1

Section 1 Basic Operation Procedure

Signal Display	1-3
Turn the power on	1-3
Execute automatic calibration	1-4
Set the signal to the center of the screen	1-4
Enlarge and display the signal	1-5
Marker Operation	1-6
"Measure" Function Check	1-8
Shifting of result position	1-9
Screen Hard Copy	1-10

The basic operation procedure of this equipment are explained here. The operations are listed on the right. Also, the explanation will advance assuming that a 500 MHz signal is applied to the input connector. Please read this manual while operating this equipment.

(: Panel key, : Soft key)

<Actual operations>

- (I) Signal display
 - 1) Turn the power on,
 - 2) execute automatic calibration,
 - 3) set the signal to the center of the screen, and
 - 4) enlarge and display the signal.
- (II) Marker operation
 - Check of the zone marker function.
 - The “marker → CF” function check.
- (III) “Measure” function check
- (IV) Screen hard copy

Signal Display

Turn the power on

Press the standby button on the rear panel, then press the power switch on the front panel. In this case, continue pressing the power switch for one second or more.

Press the Preset key.

Press the Preset All key in the menu.

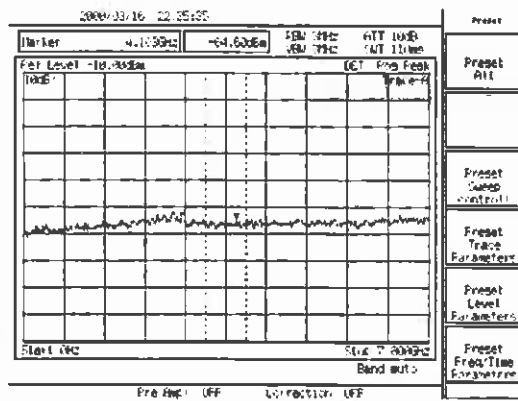

Fig. 1-1

The power is turned on/off only when the power switch is pressed for one second or more. This prevents the power from being turned on/off easily by mistake.

When the panel key (hard key) is pressed, the related soft key menu is displayed.

Partial resettings are enabled. This resetting includes only the display-related resetting or the resetting of special modes such as zone sweep.

Execute automatic calibration

Wait after switching on the power supply of the machine (warm up period) till the internal temperature becomes stable. This period is approximately 10 minutes.

After warm up, execute automatic calibration.

Press the **[Shift]** key then the **CAL** **[0]** key.

Select **All Cal** from the menu displayed on the display.

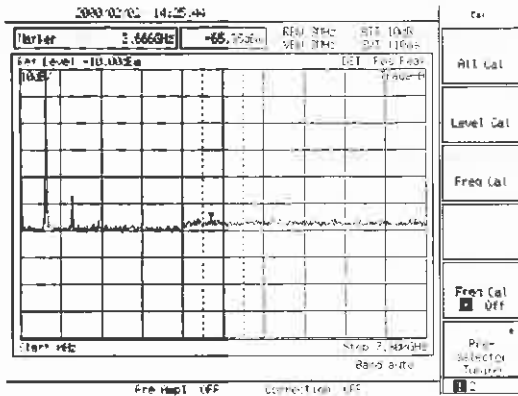

Fig. 1-2

Automatic Calibration is carried out by using an internal source without need for any external cable connection.
Refer to "Detailed Operation Instructions" for detail information about contents of calibration.

Set the signal to the center of the screen

Press the **Frequency** key.

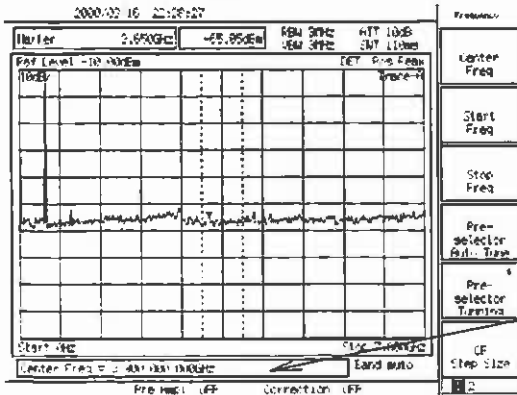

Fig. 1-3

When pressing Frequency, Span, Amplitude or Coupled Function key (s) which is used frequently, Center Frequency, Span, Reference Level, RBW or VBW function is selected and numeric value for the function can be entered into Entry area. This reduce key operation times.

This display section is called Entry area. Selecting the menu displays the current set value of the parameter. The set value can be changed by entering data in Entry area.

Press the **Shift** **GHZ** ^{Hold} key

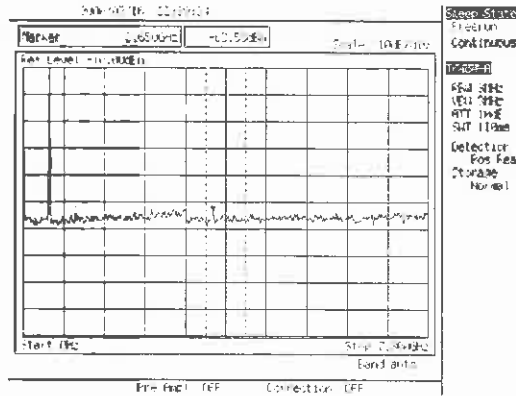

Fig. 1-4

The display of the soft key menu can be switched on/off using the **Shift** **GHZ** ^{Hold} key. When the menu disappears, the set up parameters are displayed.

Press the **Frequency** key, then use the ten-key pad (numeric keys) to enter 500 MHz.

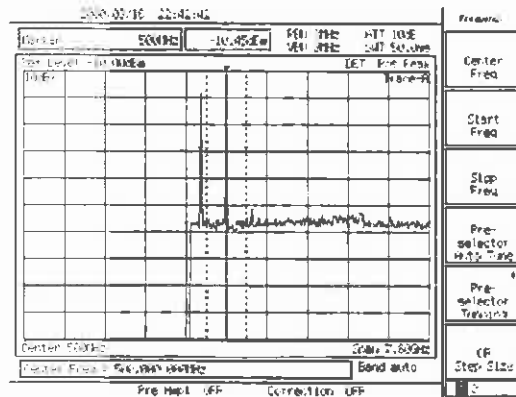

Fig. 1-5

The following three methods to input numeric values to parameters are provided: direct input by the ten-key pad (numeric keys), up/down keys, and rotary knob.

Enlarge and display the signal

Press the **Span** key, then press the **↓** down key several times to enlarge the signal display.

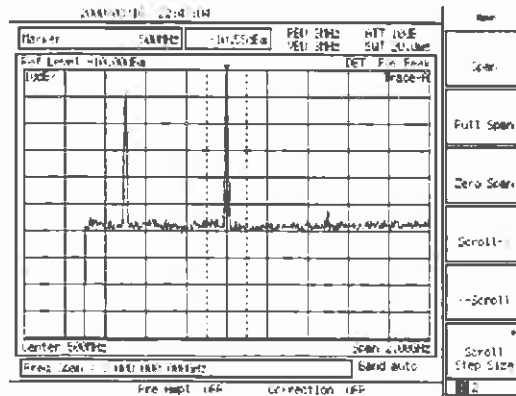

Fig. 1-6

Marker Operation

Here, check that the signal frequency and level are displayed in a marker display area. The zone marker automatically fetches the highest level signal within the zone and displays the frequency and level.

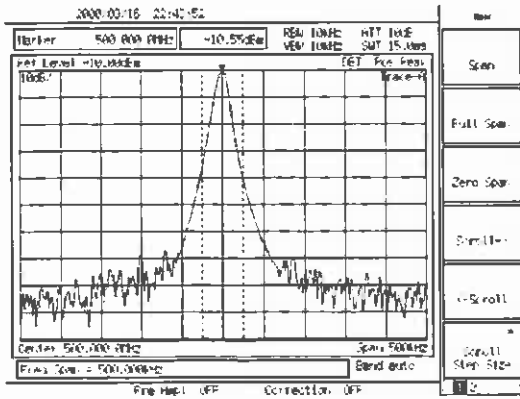

Fig. 1-7

The following items can easily be checked by the soft key menu tab: How many pages of the soft key menu being displayed currently are there?, and what page is displayed now?

To turn over the page, press the **More** key.

To check Marker → CF function, shift the signal from the center intentionally. Press the **Span** key, and then the **Scroll →** key two times.

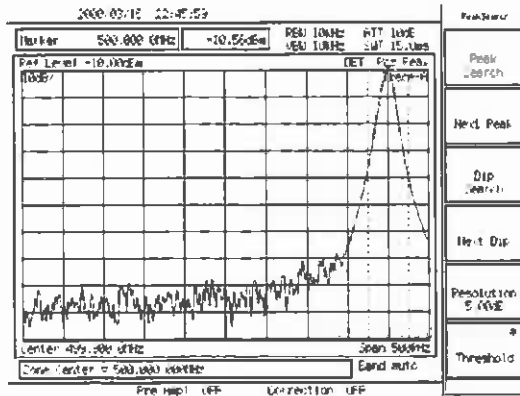

Fig. 1-8

The soft key menu marked by an asterisk on the upper right indicates that the menu can further be opened by pressing the key. Adversely, the soft key menu not marked indicates that the menu cannot be opened any more, so to speak, the end of menu opening.

Press the **Peak Search** key.

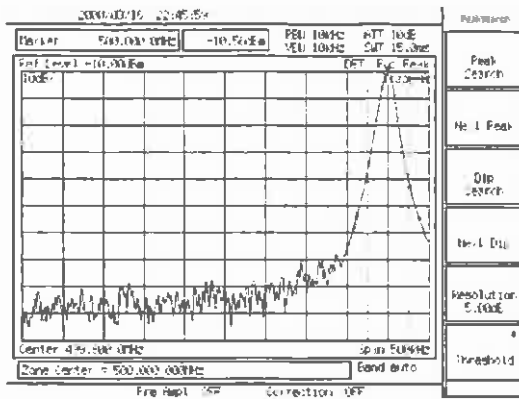

Fig. 1-9

Advanced operation memo: It is convenient that the page can also be turned over by repeatedly pressing the panel key. This method is used when key (s), such as the **Measure** key, has (have) a number of pages. Besides, the Freq/Ampl and Marker-related keys do not turn over the page by repeatedly pressing the panel key. For these keys, because the first page is important specially, it should always be displayed when the panel key is pressed.

The marker fetches the signal.

Press the **Shift** **Peak Search** key.

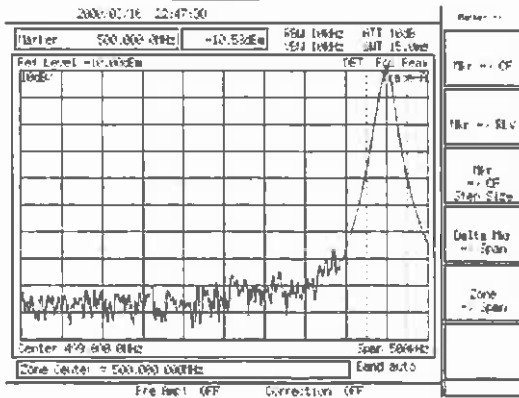

Fig. 1-10

Press the **marker -> CF** key.

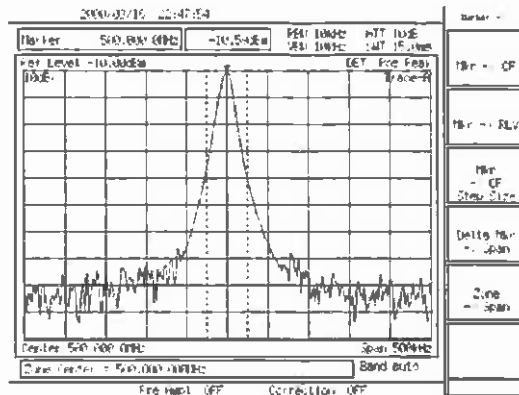

Fig. 1-11

The page opened by pressing the soft key can return to the preceding page by the **Return** key. Besides, it can be checked that which soft key menu was pressed previously to open the current menu, as the menu title is displayed on the upper row of the soft key.

Here, return to the screen of Fig. 1-8 and ensure that the screen changes to that of Fig. 1-11 only by pressing the **→ CF** key.

“Measure” Function Check

Press the **Preset** key and the **Preset All** key in order.

Press the **Peak Search** key.

If the zero beat signal level (local feed through) is larger than the signal level and the marker fetches the zero beat level, press the “Next peak” key and put the marker on the signal.

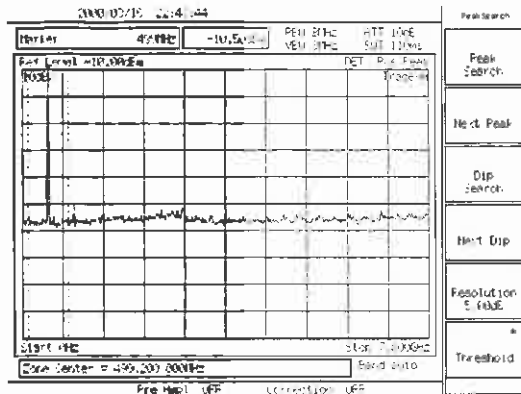

Fig. 1-12

Press the **Measure** key and the **Frequency Count** key to set the function of high accuracy frequency measurement of the marker points.

Then, press the **Count On** key and start measurement.

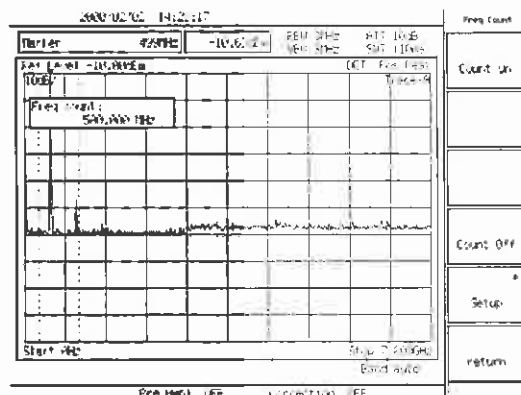

Fig. 1-13

From the screen after executing measurement, press another panel key and change parameters, and then, pressing again the **Measure** key will automatically return to the menu of this screen and not to page 1 of the menu (page learning function). It is a useful function when repeating measurement.

The frequency of marker point is displayed at the top left of the screen.

Incidentally, the internal counter correctly operates even at the full span condition, so an operation to reduce frequency span otherwise required is not necessary in this model.

Shifting of result position

Press the **Measure** key and the **Result Position*** key in order.

User can select a displayed position of measured result from 4 patterns. Displayed position is upper right, upper left, lower right, or lower left.

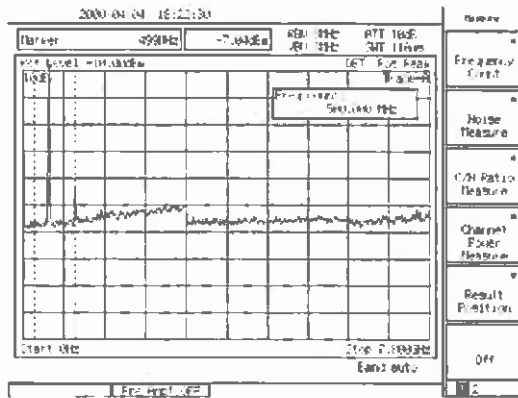

Fig. 1-14

Screen Hard Copy

The screen can be hard-copied with the BJ-M70 printer (Cannon) via a Centronics interface, and the procedures are described below:

- 1) As illustrated below, connect the Parallel connector and printer with an attached Parallel cable.
- 2) Press the **Copy** key, and the currently displayed screen is hard-copied.
If the printed copy is improper, check if the interface is correctly set in the following sequence.
- 3) Press the **Config** key.
- 4) Press the STEPDOWN **↓** key several times to get Copy Control, and check if the copy to is Printer.
If the copy to is not Printer, set the cursor to Printer with the knob and press the **set** key .
- 5) Check if the printer setup is BJ-M70 (ESC/P).
- 6) Press the **Spectrum** key and return to the spectrum screen.
- 7) Press the **Copy** key, and the currently displayed screen is hard-copied.

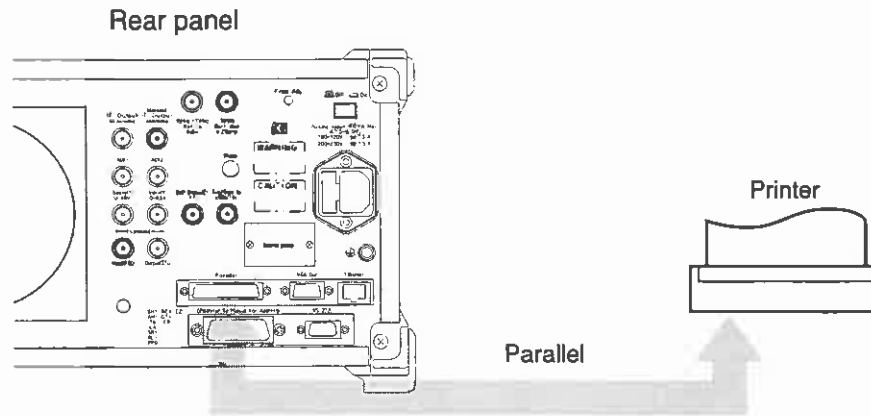

Fig. 1-14

Section 2 Frequency/Amplitude Data Entry

This section describes the data entry function related to frequency and amplitude in the Freq/Ampl section on the front panel.

Setting Observation Frequency	2-3
Soft menu in frequency key	2-4
Center-Span Mode	2-5
Start-Stop Mode	2-6
Setting Step Size with Step Keys	2-7
Fixing the frequency bands in normal mode (MS2683A)	2-8
Changing Pre-Selector start frequency (Spurious Mode, MS2683A)	2-9
Fixing the frequency band of MS2687A	2-10
Fixing the frequency band of MS2687A (Option22 loading)	2-11
Fixing the frequency band of MS2687B	2-12
Soft menu in Span key	2-13
Setting Full Scan	2-14
Setting Zero Span	2-15
Setting Frequency Scroll Step Size	2-15
Setting Level Range	2-16
Soft menu in Amplitude key	2-17
Setting Log/Linear Scale	2-18
Selecting Reference Level Units	2-19
Selecting Input Impedance	2-19
Setting Reference Level	2-20
Setting Reference Level Step Size	2-21
Offsetting Reference Level	2-22
Setting 50 Ω →75 Ω Impedance Transformer	2-23
Setting Level Frequency Correction Coefficient	2-24

Setting Observation Frequency

The observation frequency of the spectrum analyzer is set in the following two modes:

- Center-Span
- Start-Stop

The frequency setting upper and lower limits are 0 to 3.0 GHz (MS2681A), 0 to 7.8 GHz (MS2683A), 0 to 30.0 GHz (MS2687A/MS2687B).

The Frequency key is used as the header key for setting the frequency, and the Span key is used as the header key for setting the frequency span.

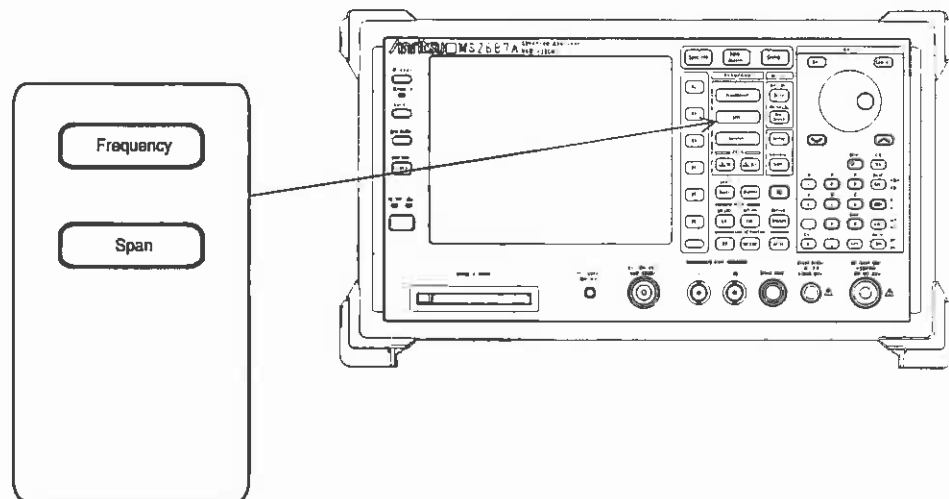

Soft menu in frequency key

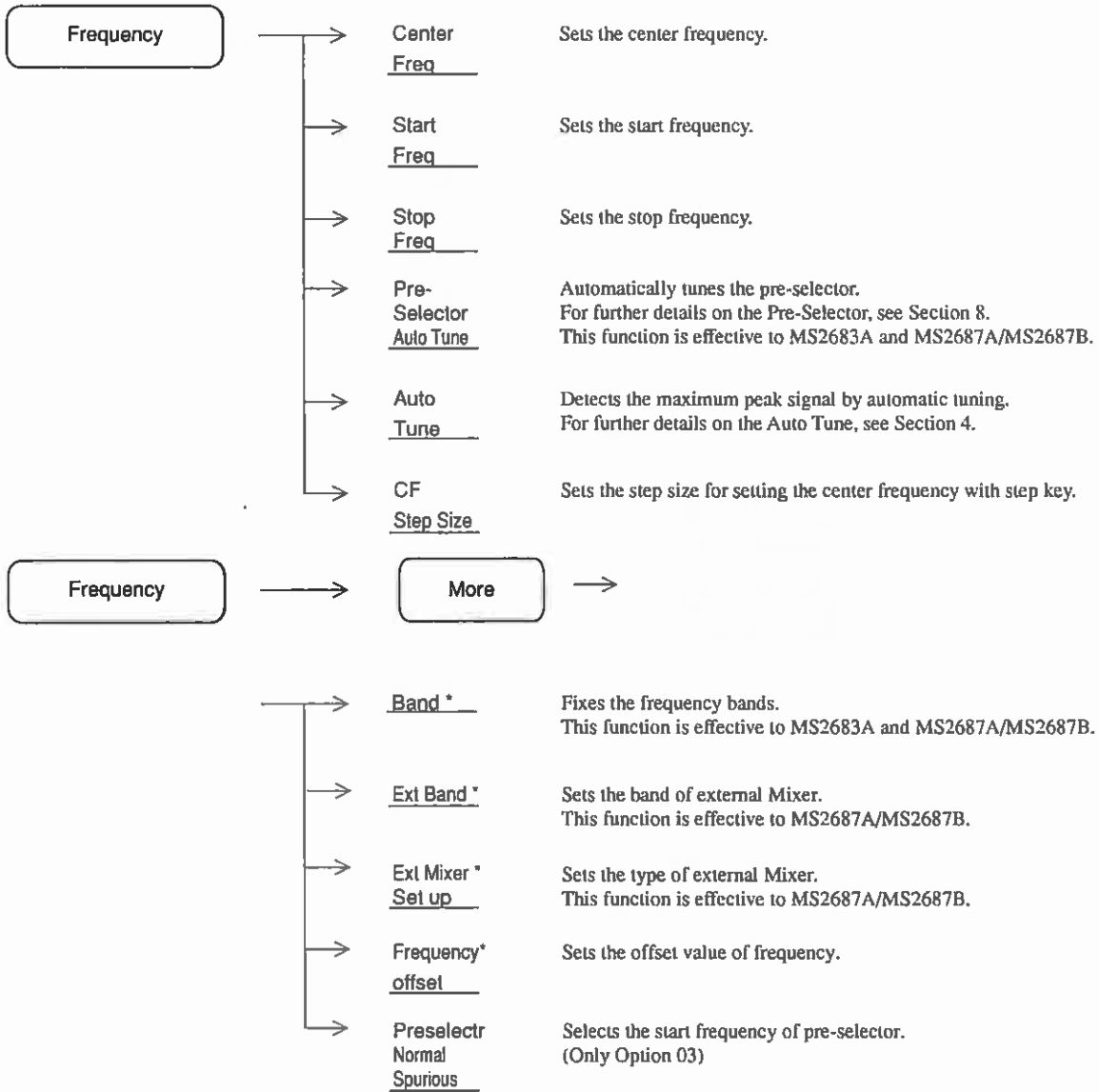

Center-Span Mode

(1) Setting center frequency

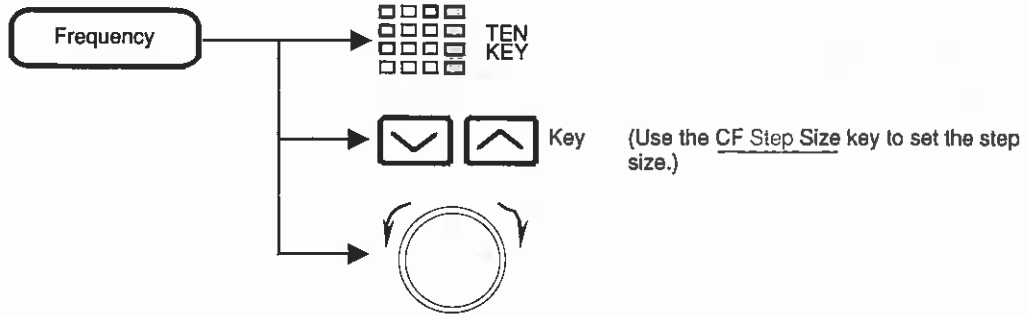

(2) Setting frequency span

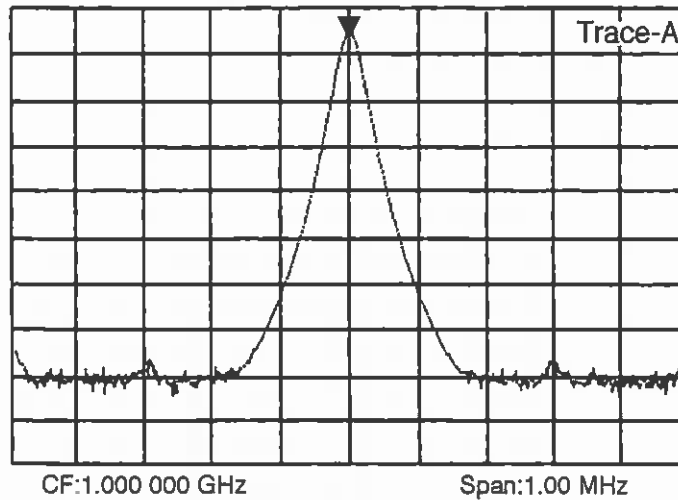
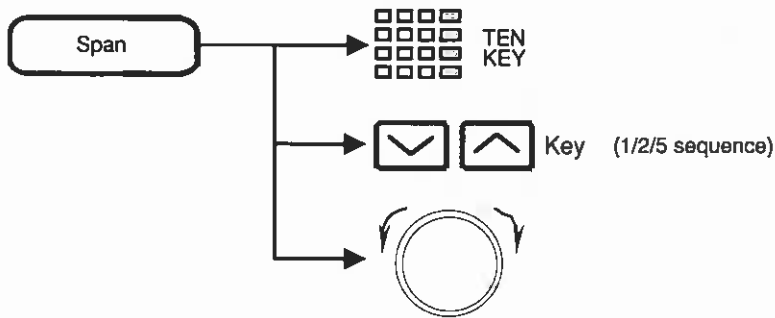

Note:

Warming up might be necessary until the observation frequency becomes stable after turning on the power.

When "Warm Up" message is being indicated at the top right corner of the indicator, please wait for approximately 3 minutes, and start the measurements after the message disappears.

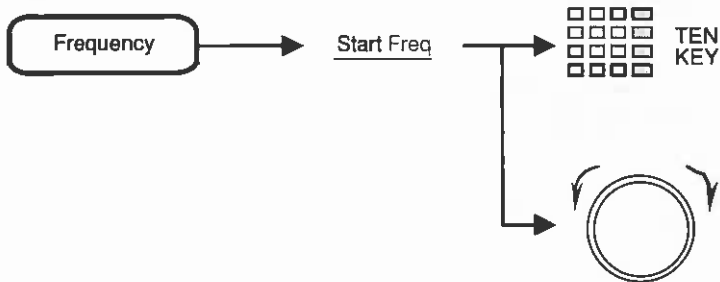

Start-Stop Mode

(1) Start frequency

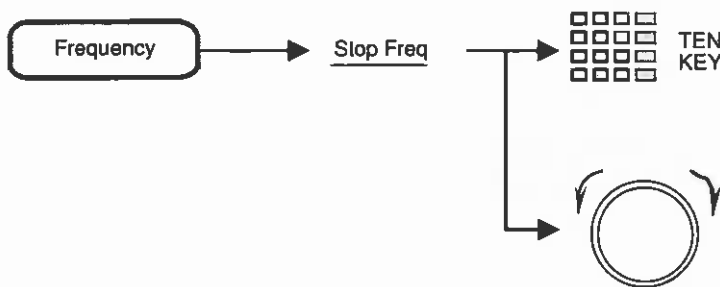

(2) Stop frequency



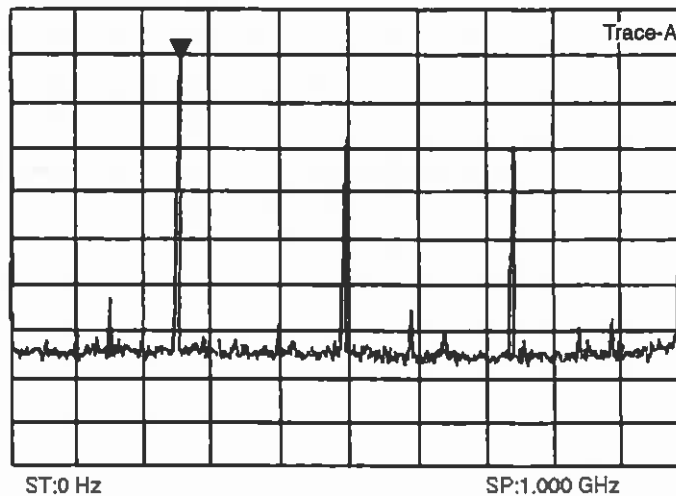

- Notes:
- Because the  and  keys are the step keys for the center frequency, the start and stop frequencies are also changed.
 - The stop frequency may also vary depending on the values of the frequency span setting resolution and start frequency.

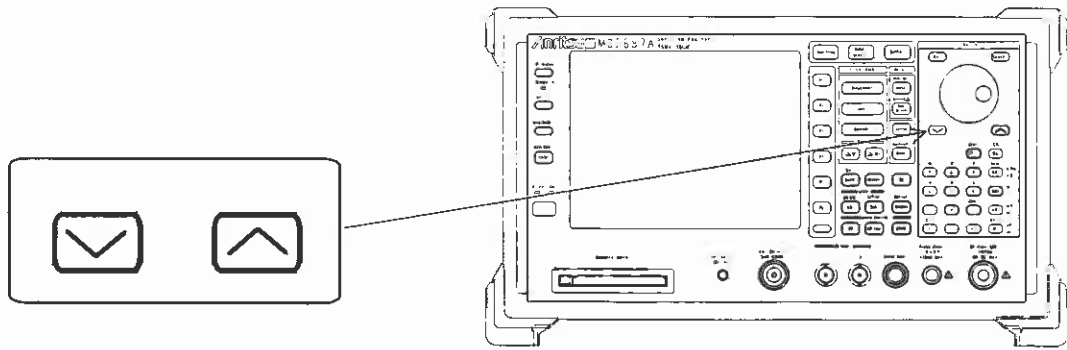

Setting Step Size with Step Keys



To use the   keys to change the step size of the center frequency, register the step size as follows:



Fixing the frequency bands in normal mode (MS2683A)

In the MS2683A, the 0 to 7.8 GHz frequency range consists of the following three bands:

- Band 0 0 to 3.2 GHz
- Band 1⁻ 3.15 to 6.3 GHz
- Band 1⁺ 6.2 to 7.8 GHz

In the initial state, the Auto Band mode that is operated by selecting the optional frequency band is selected according to the range of frequencies to be observed.

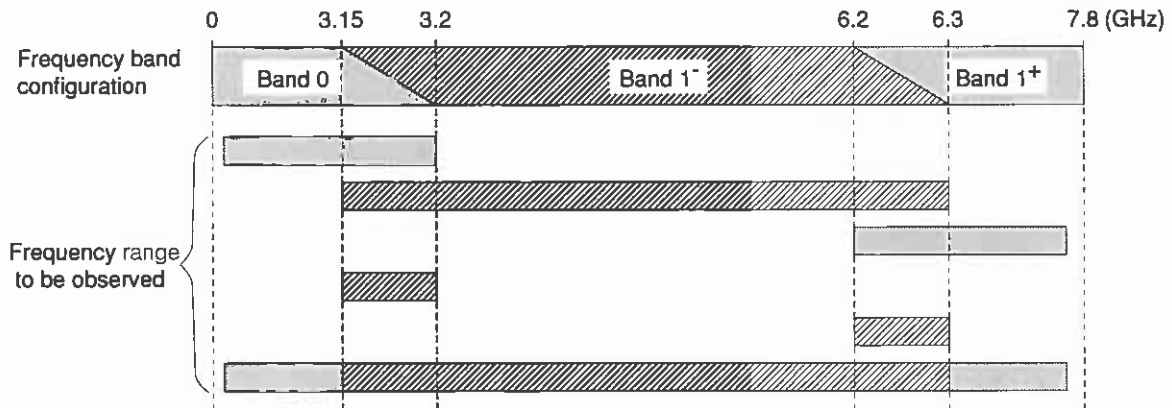

Selection of frequency bands according to range of frequencies to be observed in Auto Band mode

Perform the following to set the frequency bands, for example, when the frequency bands are switched:

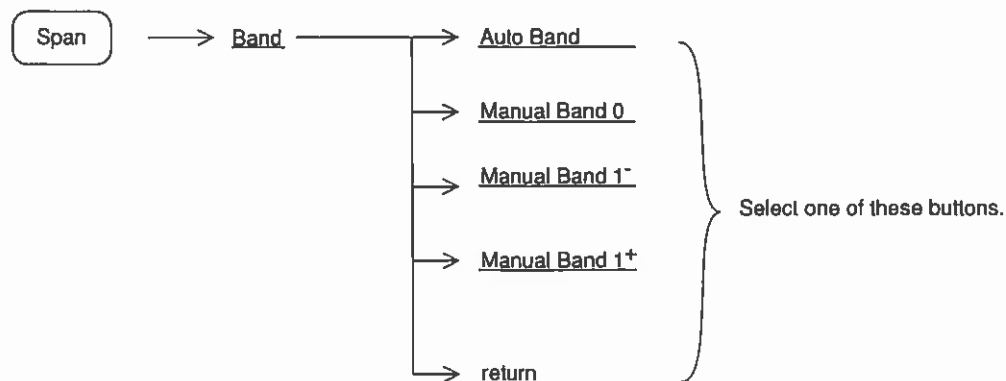

Changing Pre-Selector start frequency (Spurious Mode, MS2683A)

When installed option03 “Extension pre-selector Lower limit to 1.6 GHz” in the MS2683A frequency range consists of the following four bands:

- Band 0.....0 Hz to 3.2 GHz
- Band 1-L.....1.6 to 3.2 GHz
- Band 1-.....3.15 to 6.3 GHz
- Band 1+.....6.2 to 7.8 GHz

In the initial state, the AUTO band mode that is operated by selecting the optional frequency range is selected according to the range frequencies to be observed. Selecting the spurious mode, 1-L band in pre-selector can be used.

In case of the spurious mode, AUTO band mode is operated following figure:

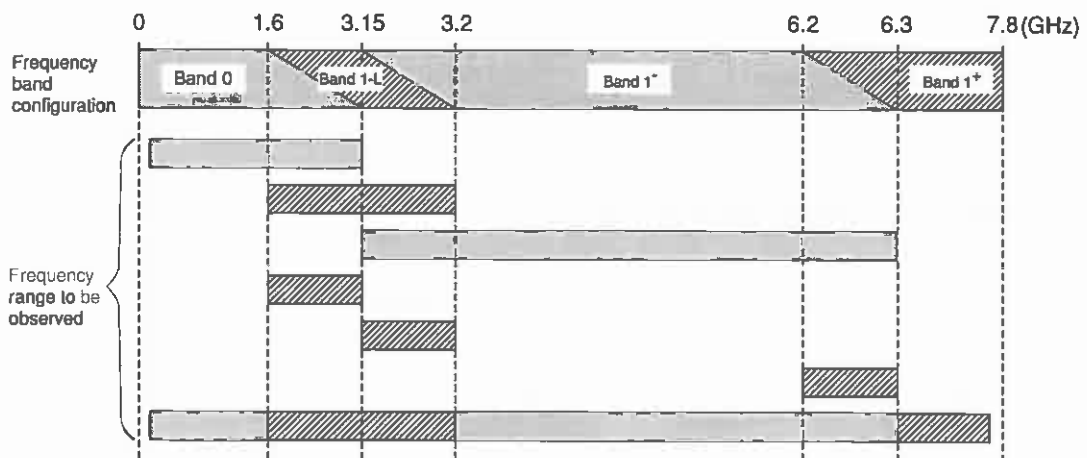

Selection of frequency bands according to range of frequencies to be observed in Auto Band mode

When use the Band 1-L, perform following procedure:



Fixing the frequency band of MS2687A

For the MS2687A, the 0 to 30.0 GHz frequency range consists of the following six bands:

- Band 0..... 0 to 3.2 GHz
- Band 1⁻ 3.1 to 6.3 GHz
- Band 1⁺ 6.2 to 7.9 GHz
- Band 2⁺ 7.8 to 15.2 GHz
- Band 3⁺ 15.1 to 22.5 GHz
- Band 4⁺ 22.4 to 30.0 GHz

Refer to section 14 for detail of the band of external mixer. In the initial state, the AUTO Band mode that is operated by selecting the optional frequency band is selected according to be observed.

Frequency band configuration

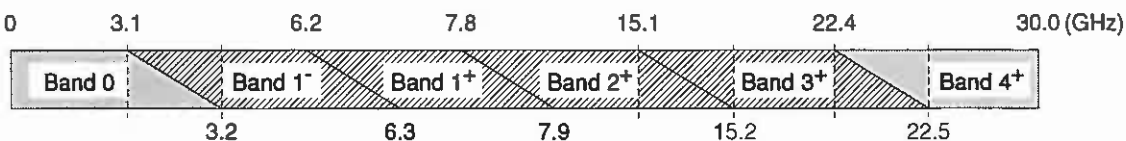

Selection of frequency bands according to range of frequencies to be observed in Auto Band mode.

Perform the following to set the frequency bands, for example, when the frequency bands are switched:

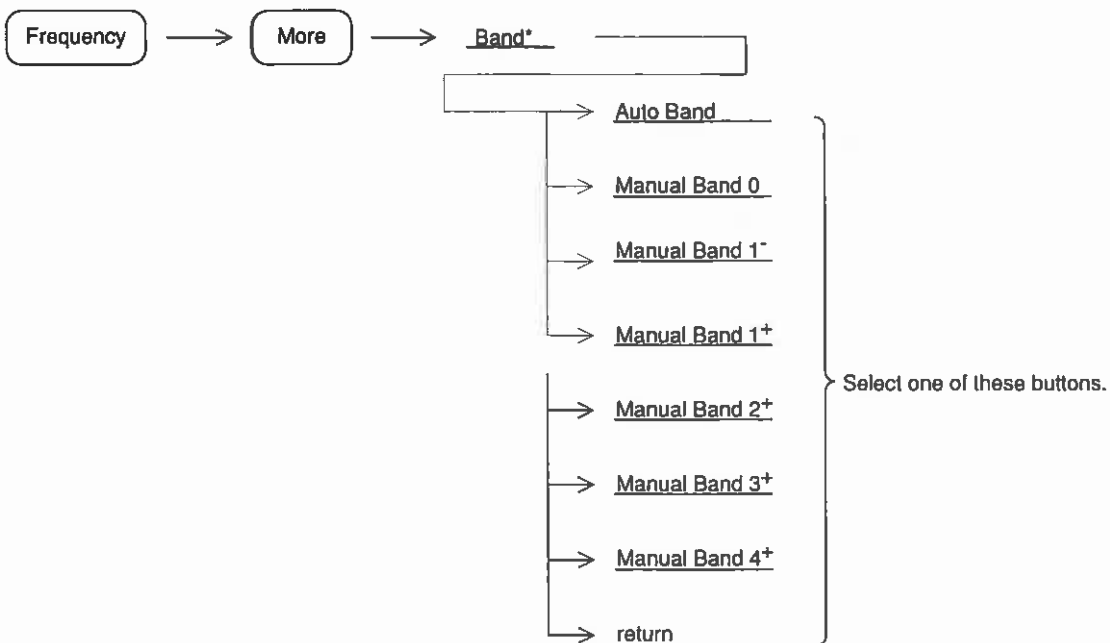

Fixing the frequency band of MS2687A (Option22 loading)

For the MS2687A, the 0 to 30.0 GHz frequency range consists of the following six bands:

- Band 0 0 to 3.2 GHz
- Band 1⁻ 3.1 to 5.8 GHz
- Band 1⁺ (n=1) 5.7 to 7.9 GHz
- Band 1⁺ (n=2) 7.8 to 14.05 GHz
- Band 2⁻ 14.0 to 26.5 GHz
- Band 3⁻ 26.4 to 30.0 GHz

Refer to section 14 for detail of the band of external mixer. In the initial state, the AUTO Band mode that is operated by selecting the optional frequency band is selected according to be observed.

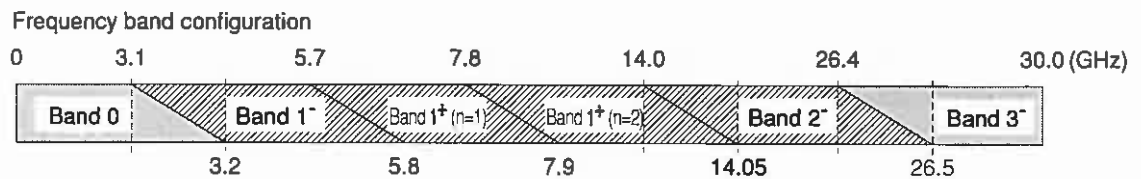

Selection of frequency bands according to range of frequencies to be observed in Auto Band mode.

Perform the following to set the frequency bands, for example, when the frequency bands are switched:

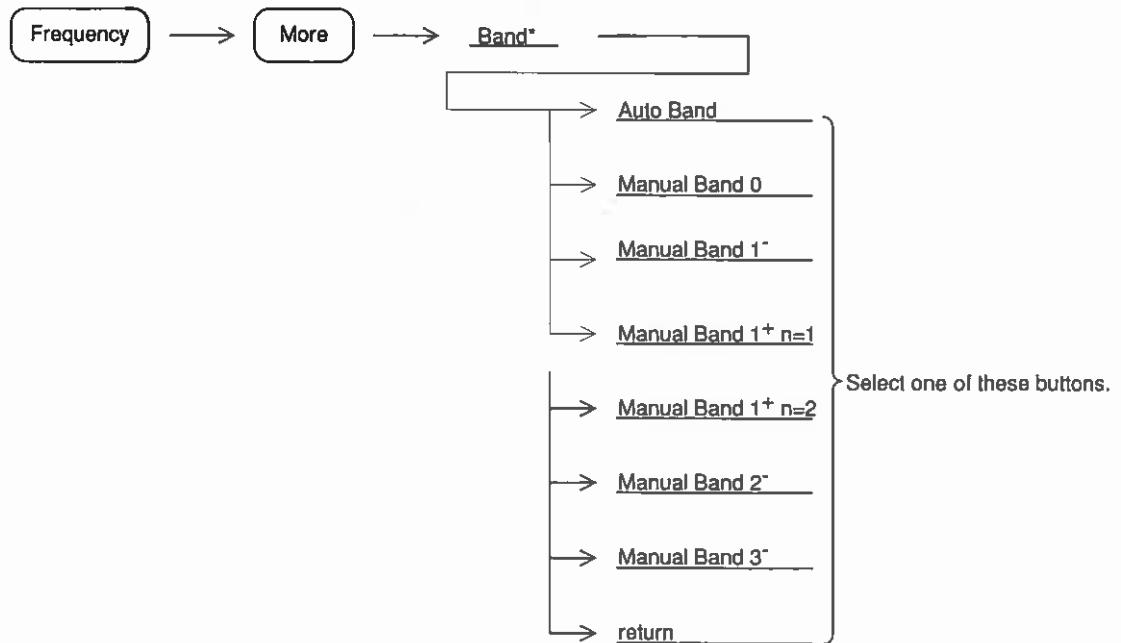

Fixing the frequency band of MS2687B

For the MS2687B, the 0 to 30.0 GHz frequency range consists of the following six bands:

- Band 0..... 0 to 3.2 GHz
- Band 1⁻ 3.1 to 6.3 GHz
- Band 1⁺ 6.2 to 7.9 GHz
- Band 2⁺ 7.8 to 15.3 GHz
- Band 4⁺ 15.2 to 30.0 GHz

Refer to section 14 for detail of the band of external mixer. In the initial state, the AUTO Band mode that is operated by selecting the optional frequency band is selected according to be observed.

Frequency band configuration

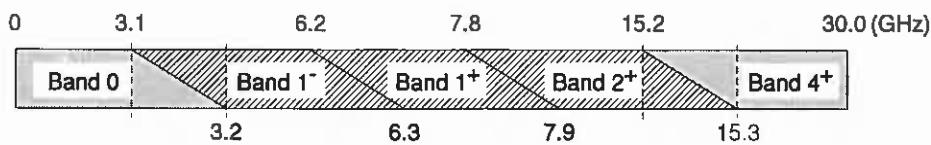

Selection of frequency bands according to range of frequencies to be observed in Auto Band mode.

Perform the following to set the frequency bands, for example, when the frequency bands are switched:

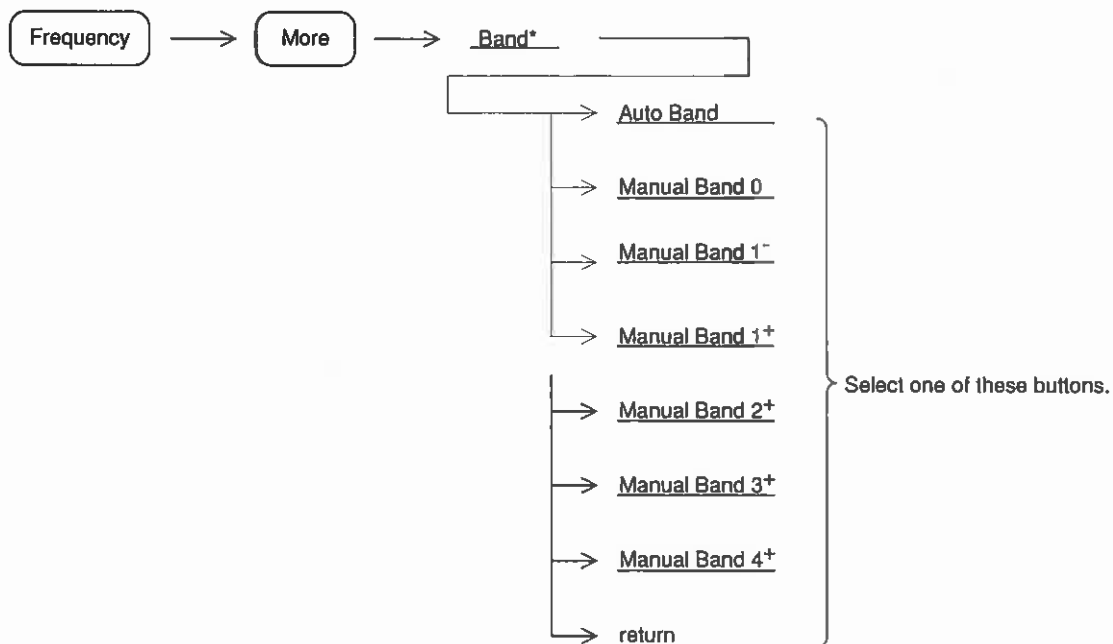

Soft menu in Span key

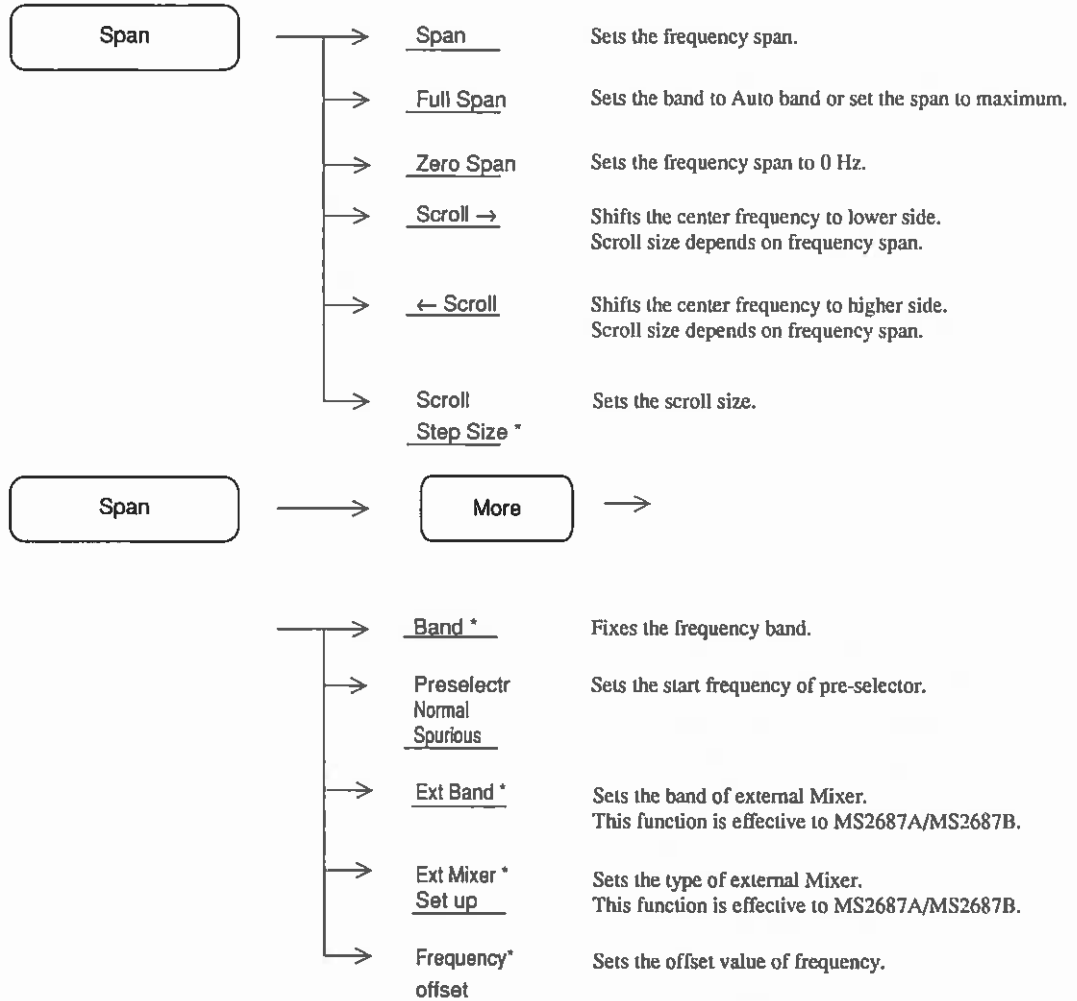

Setting Full Scan

In the normal operating state, pressing the Preset key allows the entire frequency range of the spectrum analyzer to be swept over the full span. However, this setting also initializes the parameters except the frequency range.

To set the full span and leave the other parameters unchanged, perform the following key operations.



[MS2681A]

0 to 3.0 GHz

[MS2683A]

Auto band, 0 to 7.8 GHz

For Band 0, 0 to 3.2 GHz

For Band 1⁻, 3.15 to 6.3 GHz

For Band 1⁺, 6.2 to 7.8 GHz

[MS2687A]

AUTO BAND, 0 to 30 GHz

For Band 0, 0 to 3.2 GHz

For Band 1⁻, 3.15 to 6.3 GHz

For Band 1⁺, 6.2 to 7.9 GHz

For Band 2⁺, 7.8 to 15.3 GHz

For Band 3⁺, 15.2 to 22.5 GHz

For Band 4⁺, 22.4 to 30.0 GHz

[MS2687A Opt22 loading]

AUTO BAND, 0 to 30 GHz

For Band 0, 0 to 3.2 GHz

For Band 1⁻, 3.15 to 5.8 GHz

For Band 1⁺ (n=1), 5.7 to 7.9 GHz

For Band 1⁺⁺ (n=2), 7.8 to 14.05 GHz

For Band 2⁻, 14.0 to 26.5 GHz

For Band 3⁻, 26.4 to 30 GHz

[MS2687B]

AUTO BAND, 0 to 30 GHz

For Band 0, 0 to 3.2 GHz

For Band 1⁻, 3.15 to 6.3 GHz

For Band 1⁺, 6.2 to 7.9 GHz

For Band 2⁺, 7.8 to 15.3 GHz

For Band 4⁺, 22.4 to 30.0 GHz

Setting Zero Span

The Spectrum Analyzer can operate as a selective level meter in which the horizontal axis is graduated as a time axis by setting the frequency span to 0 Hz. The rising and falling edges of burst waves can also be observed and measured.

Performing any of the following key operations allows the spectrum analyzer to operate in the zero span (time domain) mode.

- Span → 0 → Hz
- Span → Zero Span
- Time

For further details on the zero span (time domain) mode, refer to Section 5 “Selecting the Display Method.”

In the frequency and time domains, the RBW, VBW, Sweep time and other coupling functions time can be set to different values. For further details, refer to Section 7 “Coupled Function.”

Setting Frequency Scroll Step Size

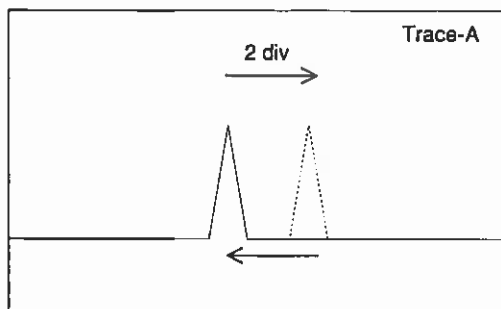
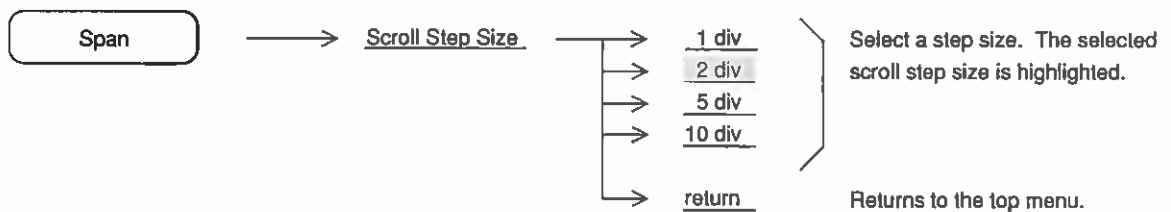

The waveform scrolls 2 divs to the right.



The waveform scrolls 2 divs to the left.

Setting Level Range

The table below shows the types of level display modes and the ranges of the reference level (top graticule of the amplitude scale) for the different modes.

		50 Ω (standard)
Display mode	Units	Reference Level range
Log scale	dBm	-120 to +40 dBm
	dB μ V	+7 to +147 dB μ V
	dBmV	-53 to 87 dBmV
	V	2.24 μ V to 22.4 V
	dB μ V (emf)	+13 to +153 dB μ V
	W	100 fW to 10 W
	dB μ V/m	-----
Linear scale	V	2.24 μ V to 22.4 V

dBm: dBm unit system where 1 mW/50 Ω or 75 Ω is defined as 0 dBm.

dB μ V: dB μ V unit system where 1 μ V is defined as 0 dB μ V, and the terminal voltage display is terminated into 50 Ω or 75 Ω .

dBmV: dBmV unit system where 1 mV is defined as 0 dBmV, and the terminal voltage display is terminated into 50 Ω or 75 Ω .

dB μ V (emf): dB μ V (emf) unit system based on the open-voltage display, and dB μ V +6 dB is fed as the output value.

The Amplitude key is used as the header key for setting the amplitude level.

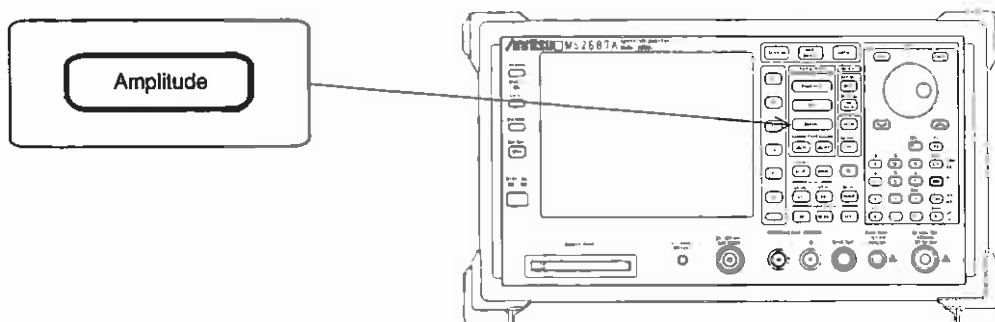

Soft menu in Amplitude key

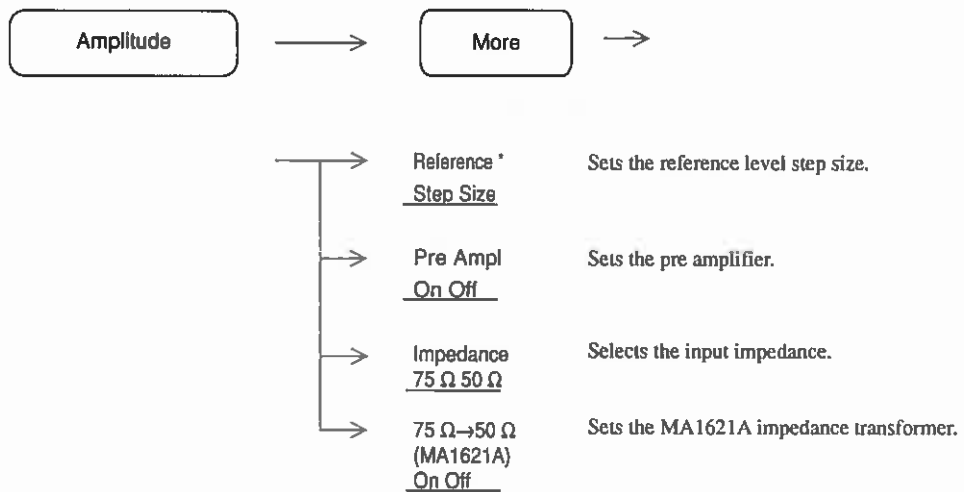
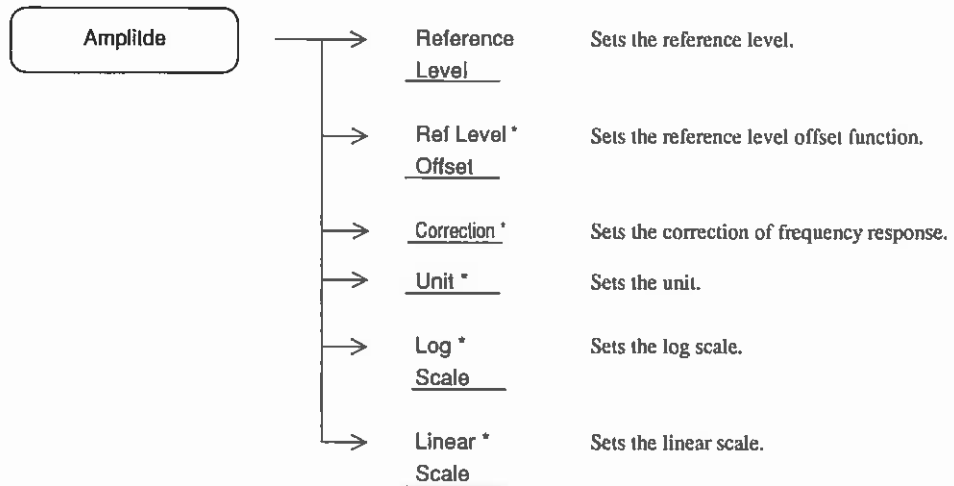

Setting Log/Linear Scale

To set the amplitude scale to log scale or linear scale, perform the following key operations:

(1) Setting log scale

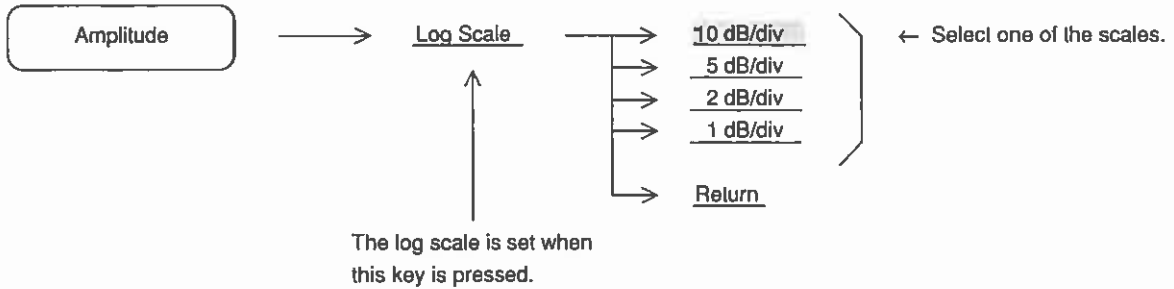

(2) Setting linear scale

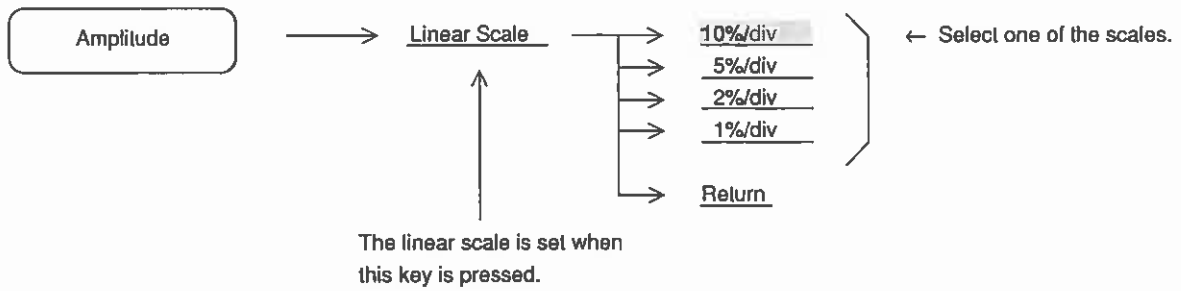

The reference level remains constant, independent of switching between log and linear scales.

When the reference level is set to less than -80 dBm in the log scale mode, the reference level of the linear scale is switched to $22.4 \mu\text{V}/50 \Omega$ or $27.4 \mu\text{V}/75 \Omega$.

Selecting Reference Level Units

In the log scale mode, the spectrum analyzer provides six types of reference level units: dBm, dB μ V, dBmV, V, dB μ V (emf), dB μ V/m, and W. To select one of the reference level units, perform the following key operations:

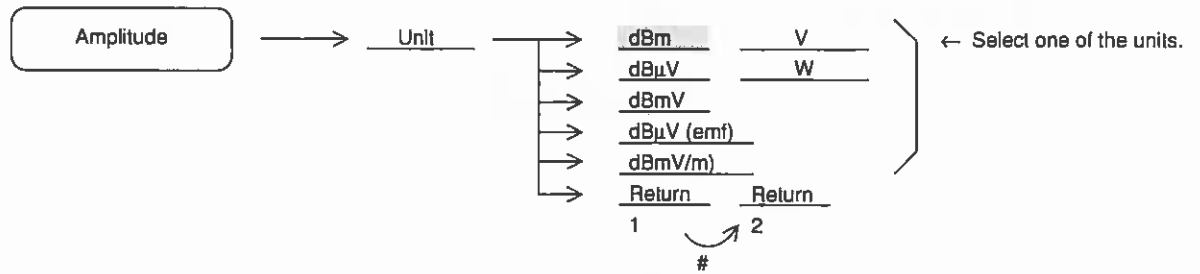

To turn the page, press the **More** key.

Because the reference level unit used for the linear scale is only V, there is nothing to select.

Selecting Input Impedance

This function is a standard: 50 Ω model dedicated function.

The input impedance of the spectrum analyzer is 50 Ω . Measurement with 75 Ω can be enabled by using 50 Ω →75 Ω Impedance Transformer. In this case, measured value is level converted.

When the input impedance is set to 75 Ω as shown in the figure below; measured value is level converted, and displayed according to the level unit of the dB μ V/dBmV/dB μ V (emf)/V.



When the input impedance is set to 75 Ω , the level is displayed after adding +1.8 dB to the 50 Ω level, and "75 Ω " is displayed at the bottom left of the waveform.

When the MA1621A is used as the 50 Ω →75 Ω Impedance Transformer, the insertion-loss frequency characteristics of the MA1621A must be compensated. The spectrum analyzer has the level-compensation function. (See p.2-23 "Setting 50 Ω →75 Ω Impedance Transformer (MA1621A)".)

Setting Reference Level

Select the reference level (top graticule of the amplitude scale) by performing the following key operations:

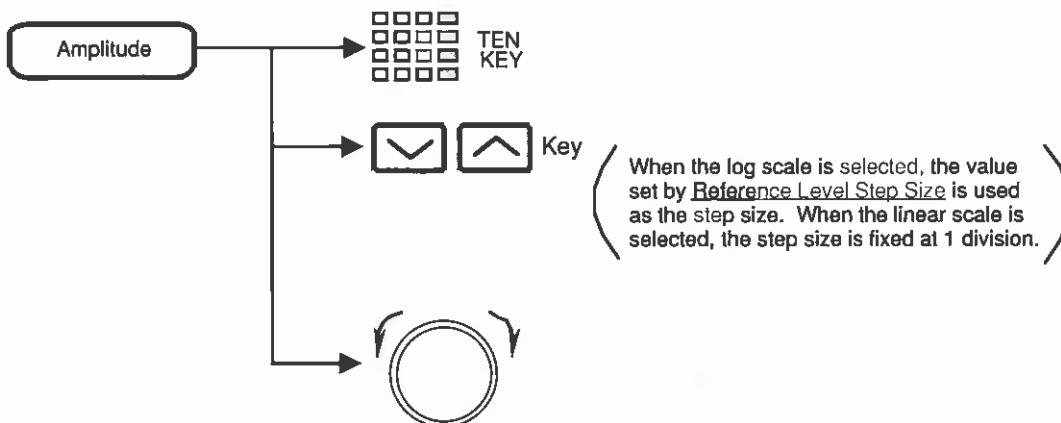

Use the unit key as follows, according to the set reference level unit.

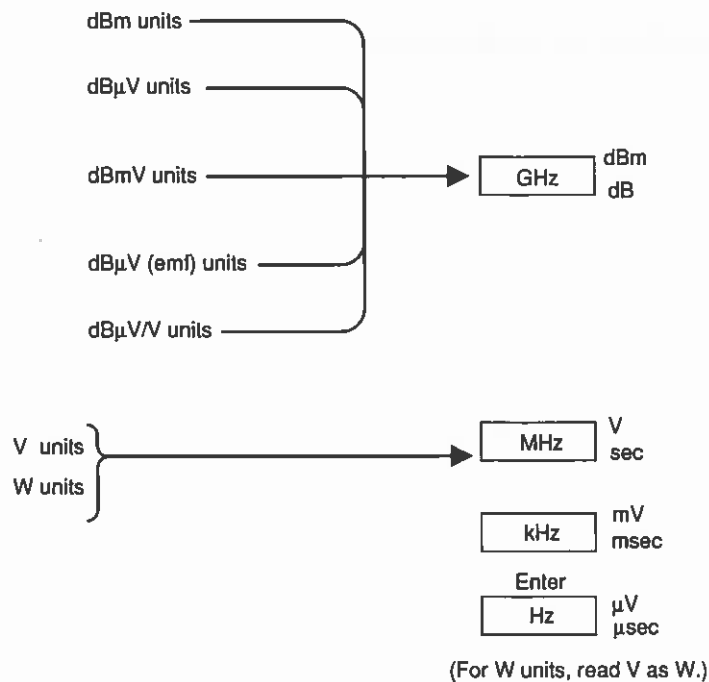

Setting Reference Level Step Size

To change the reference level with the   keys, set the step size by performing the following key operations:

(1) Log scale

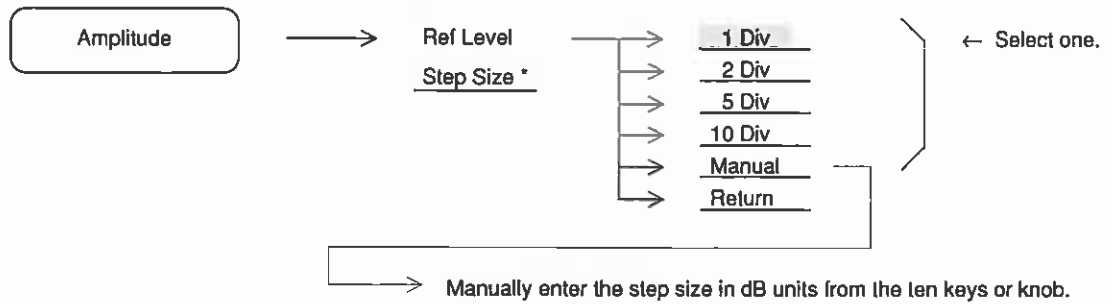

(2) Linear scale

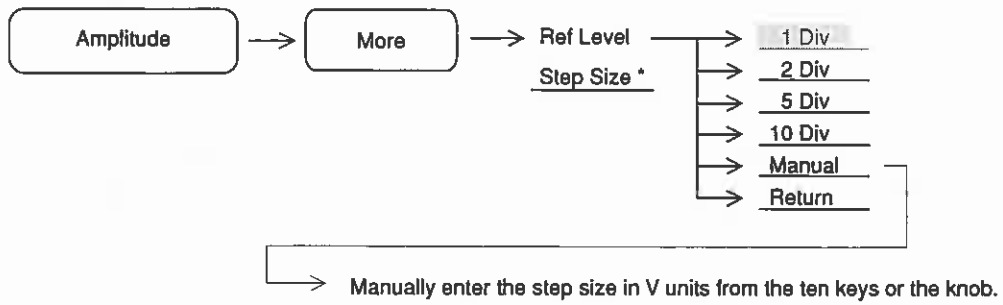

Offsetting Reference Level

The reference level and waveform trace can be displayed by adding a given offset.

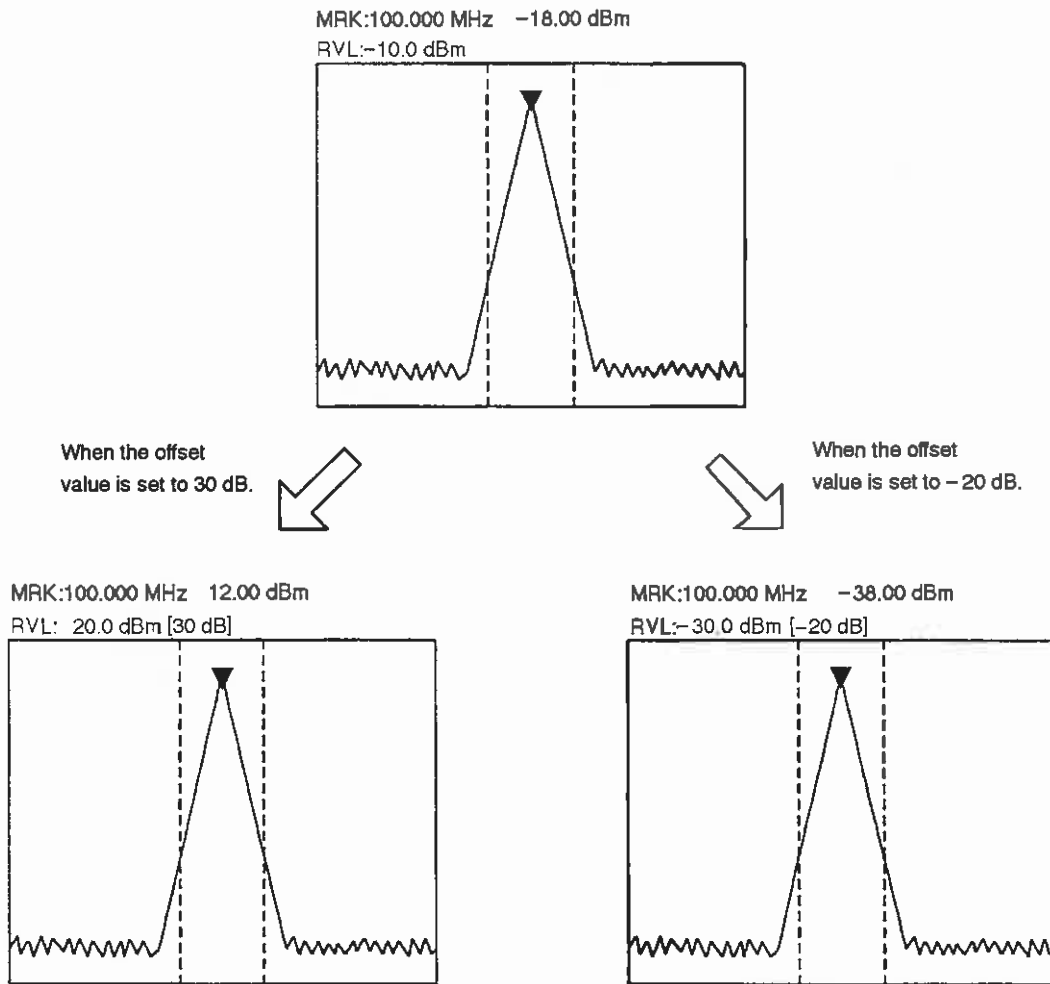

The offset value is displayed to [] right of the reference level displayed above the scale.

Turn the offset display On/Off and set its offset value by performing the following key operations:

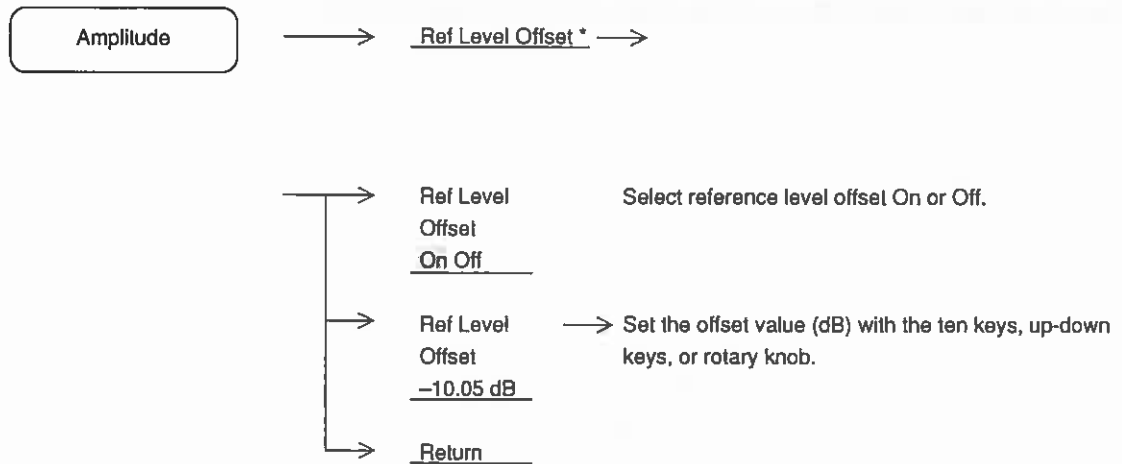

The offset value setting range is from -100 to $+100$ dB. The offset value resolution is 0.01 dB.

Setting $50\ \Omega \rightarrow 75\ \Omega$ Impedance Transformer

When the optional MA1621A ($50\ \Omega \rightarrow 75\ \Omega$) impedance transformer is installed to the RF input attenuator (see the figure below), set the input impedance to $75\ \Omega$.

Press the **Amplitude** key, then press **More** key.

When the input impedance is set to On; it is assumed that a $25\ \Omega$ resistor is connected in series with the input, the level is converted for $75\ \Omega$, the insertion-loss frequency characteristic is corrected, and then the measured result is displayed.

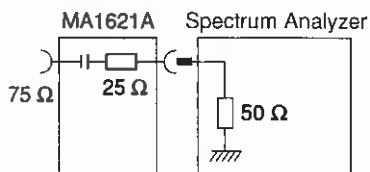

Setting Level Frequency Correction Coefficient

This function corrects the level-frequency characteristics of the cables and pads (connected to the front end of the RF Input connector) so that the level becomes flat. Correction tables are written via the RS-232C or GPIB interface.

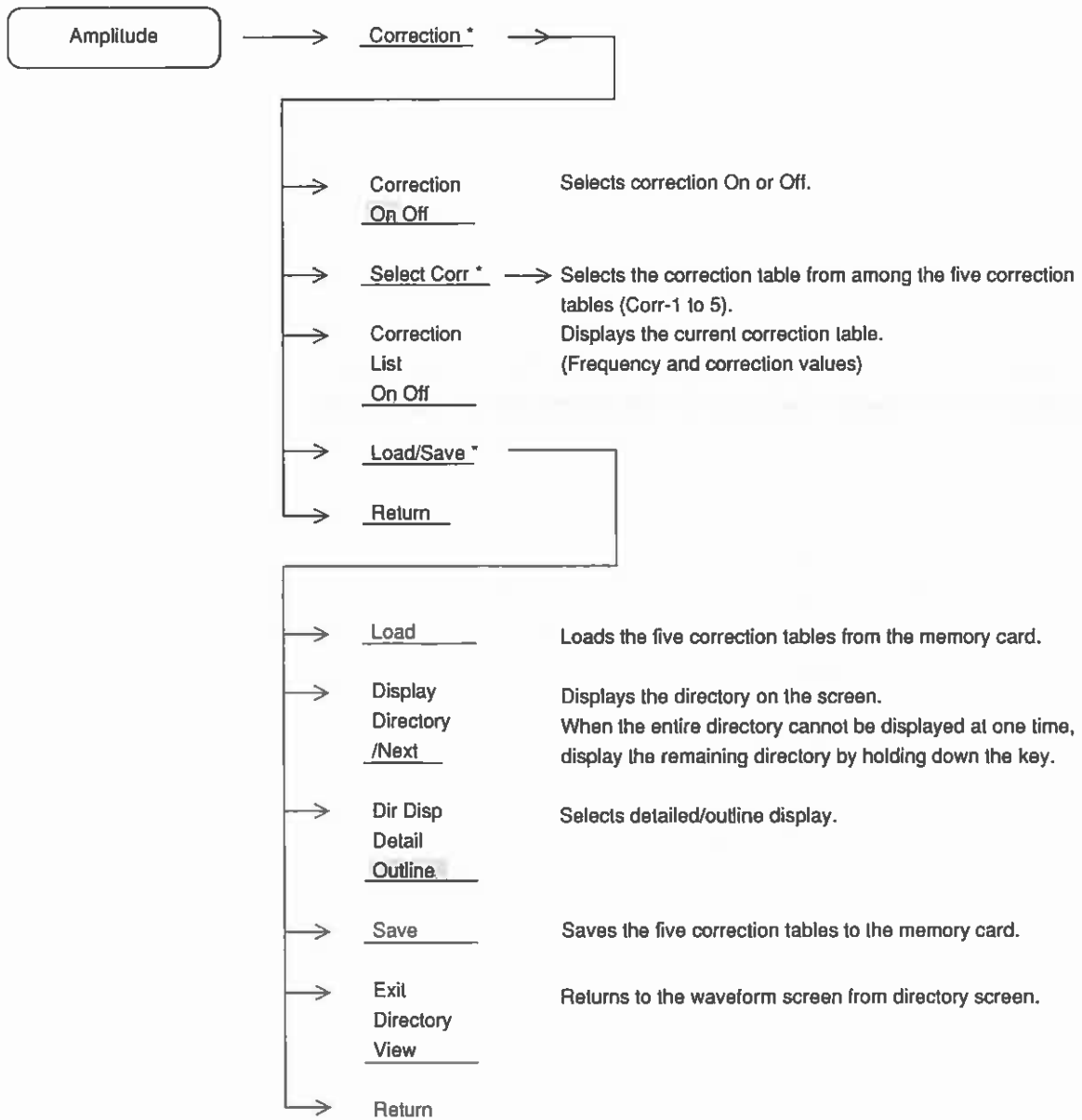

For further details, refer to Section 8.

Section 3 Marker Functions

This section describes the marker functions, such as the zone marker, marker mode menu, marker search, and the parameters set by marker value, for improving the measurement efficiency.

For a description of marker tracking and zone sweep setting, refer to Section 6 "Selecting the Sweep Method."

Changing Zone Marker Position and Width	3-4
Changing Zone Marker Width	3-4
Changing Zone Marker Position	3-6
Marker Mode	3-7
Normal Marker	3-7
Delta Marker	3-8
Marker Off	3-9
Switching Marker Search Mode	3-9
Display Line	3-10
Setting Display Line	3-10
Zone Sweep and Signal Tracking	3-11
Zone Sweep	3-11
Signal Tracking	3-12
Multimarker	3-13
Highest 10 Multimarker	3-13
Harmonics Multimarker	3-14
Peak Hold Multimarker	3-14
Marker List	3-15
Manual Set	3-16
Multimarker Off	3-17
Marker Search	3-18
Peak Search	3-18
Next Peak Search	3-19
Dip Search	3-20
Next Dip Search	3-21
Setting Search Resolution	3-21
Setting Search Threshold	3-22
Setting Parameters Using Marker Values	3-23
Mkr → CF/Mkr → RLV	3-24
Mkr → CF Step Size	3-25
Delta Mkr → Span	3-26
Zone → Span	3-27

The keys inner section are used as the header keys for setting the marker functions.

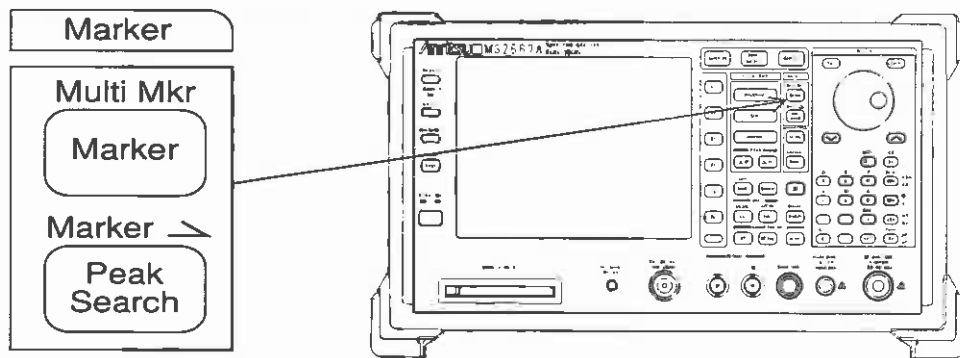

Changing Zone Marker Position and Width

The part enclosed in dotted lines in the center of the screen shown in the figure below is called the zone marker. The current marker within this zone marker normally moves to the maximum level. The frequency (or time for time domain mode) and level at the current marker point (intensified point) are displayed at the top left-hand corner of the screen.

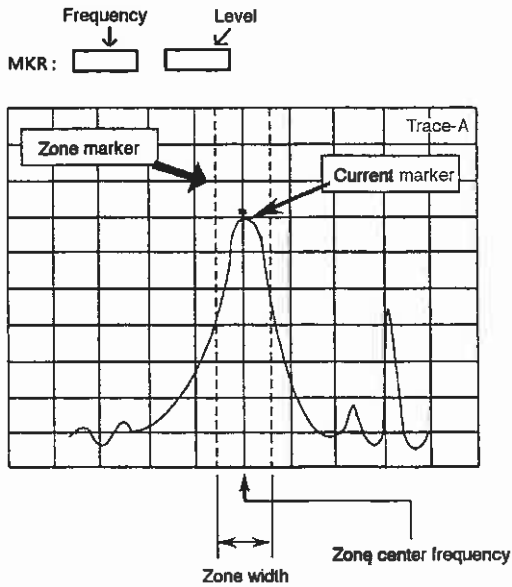

Changing Zone Marker Width

The zone marker width is initially set to 1 division, but can be changed from 1 point to 10 divisions by performing the following key operations.

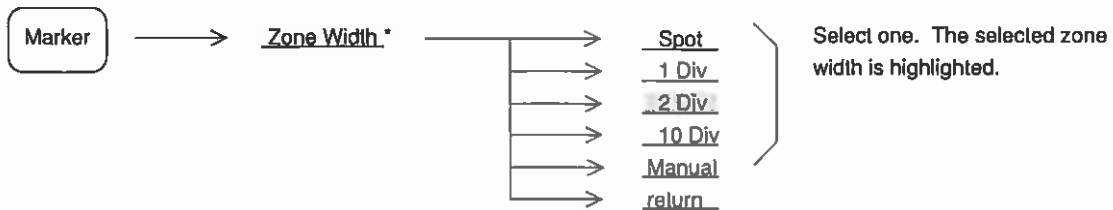

The zone marker width can be arbitrarily set from 1 point to 10 divisions by rotary knob. The zone marker width can be arbitrarily set from 1 point to 10 divisions by the corresponding frequency input from the ten keys.

When the zone marker width is set to 1 point (Spot), the zone marker becomes a vertical line. This is called a spot marker. Since the marker center frequency and the current marker frequency coincide, the level at the desired frequency can be measured.

Example of Spot Marker (Zone Width: 1 Point)

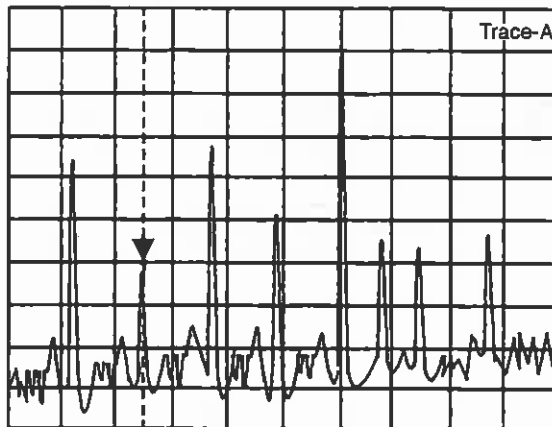

If the zone marker is set to 10 divisions when the zone center frequency is at the center of the frequency axis on the screen, the current marker will always move to the maximum peak level over the entire range of the observation frequency.

Example of Zone Width: 10 Divisions

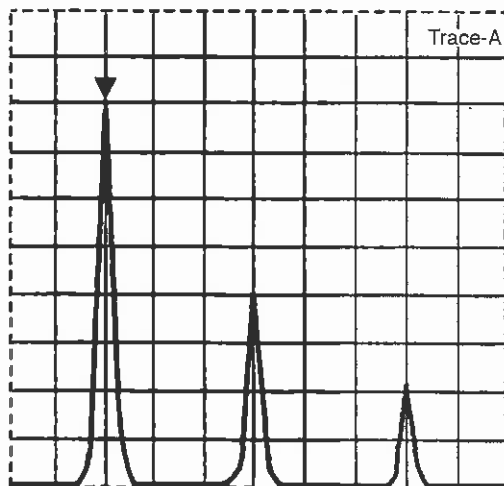

Since the zone width in the time domain mode always becomes 1 (Spot), it cannot be changed.

Changing Zone Marker Position

The center frequency (time) of the zone marker is initially centered on the frequency (time) axis on the screen. By performing the following key operations, the zone marker can be moved from the left end to the right end of the frequency axis (time) on the screen.

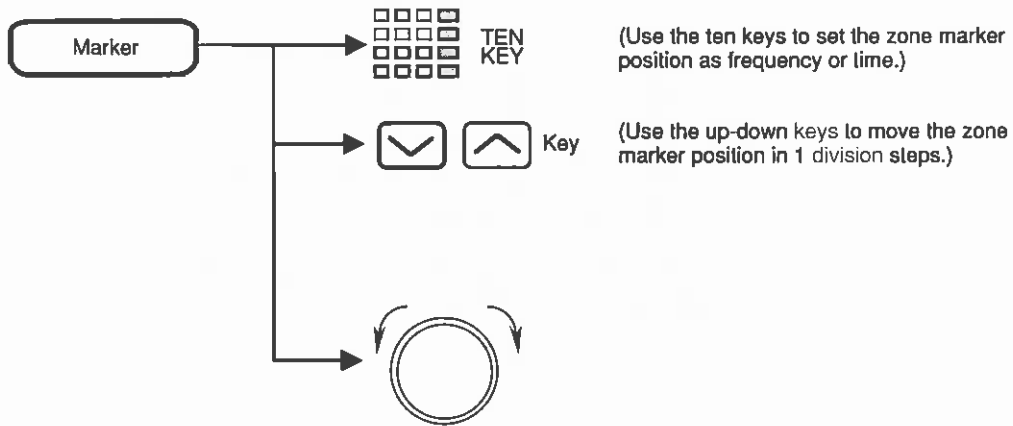

In the delta marker mode, setting the zone marker center frequency (time) with the ten keys results in entry of the delta marker value (difference between reference marker and current marker).

Marker Mode

Three types of markers can be used with the spectrum analyzer: normal marker, delta marker, and multimarker.

Normal Marker

A single marker is indicated by ▼ at the maximum level within the zone marker. The frequency and level at that point are displayed digitally.

The normal marker is initially set to ON. When the current state is another marker mode, or when the normal marker is set to OFF, perform the following key operations to set the normal marker to ON:

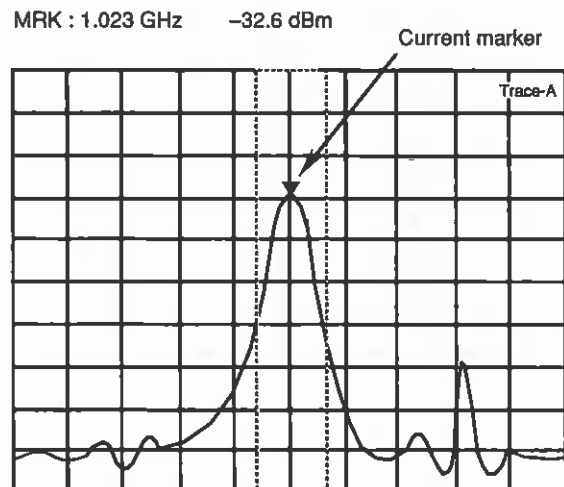

The normal marker displays the absolute level. By setting a display line, the normal marker can also display the level relative to a given level specified as a reference line.

Delta Marker

The current marker position when the delta marker is set to On is fixed as the reference marker (reference point). Then, as the current marker is moved, the reference marker and current marker frequency (time) and level differences are displayed digitally as delta marker values.

In the delta marker mode, the reference marker is indicated by \square .

To set the delta marker to On, perform the following key operations:

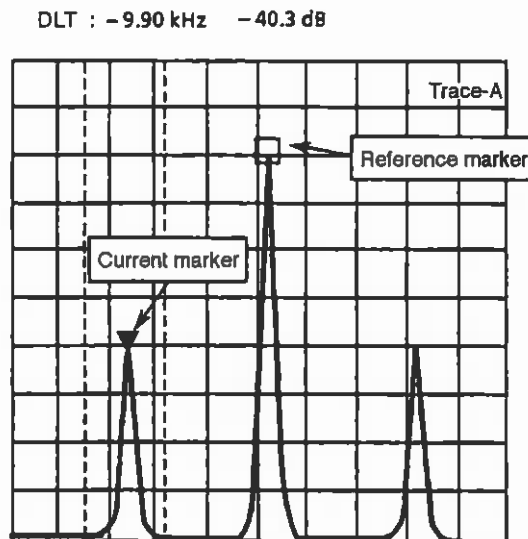

Press the Delta Marker key in the delta maker mode. The reference marker moves to the current marker position and switches to the delta marker mode with that point as the reference point.

Varying the spectrum waveform in the delta marker mode does not change the marker frequency level. The reference marker is not necessarily always on the waveform because it remains unchanged. Also, when the reference marker cannot be positioned on the screen by changing the observation frequency and level and range, it is at the edge of the scale lines.

The marker mode at delta marker-ON becomes the normal mode when the scale mode is changed from log scale to linear scale and vice-versa. If the scale mode was changed, set the delta marker again.

Marker Off



The marker disappears from the screen. When the Normal Marker key is pressed, the marker is displayed.

Switching Marker Search Mode

Searching the maximum value (Peak) or minimum value (Dip) in the zone marker is selected by pressing this key. Usually select Peak.

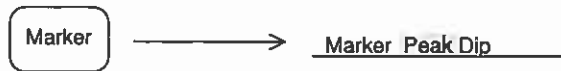

Display Line

In the state in which a horizontal line which indicates a given level is displayed on the scale, the display line can be used as the frequency response measurement guideline, or as the reference line of the marker level measurement or pass/fail judgement with a standard line.

Setting Display Line

To turn the display-line On and Off and to set the display-line level (frequency deviation), perform the following key operations:

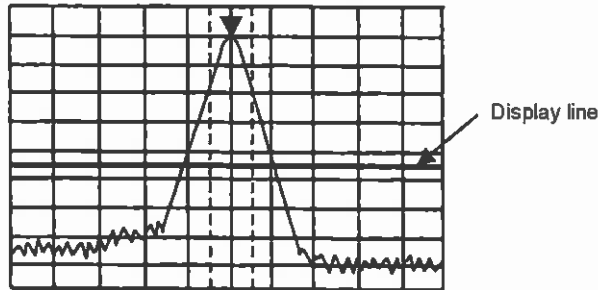
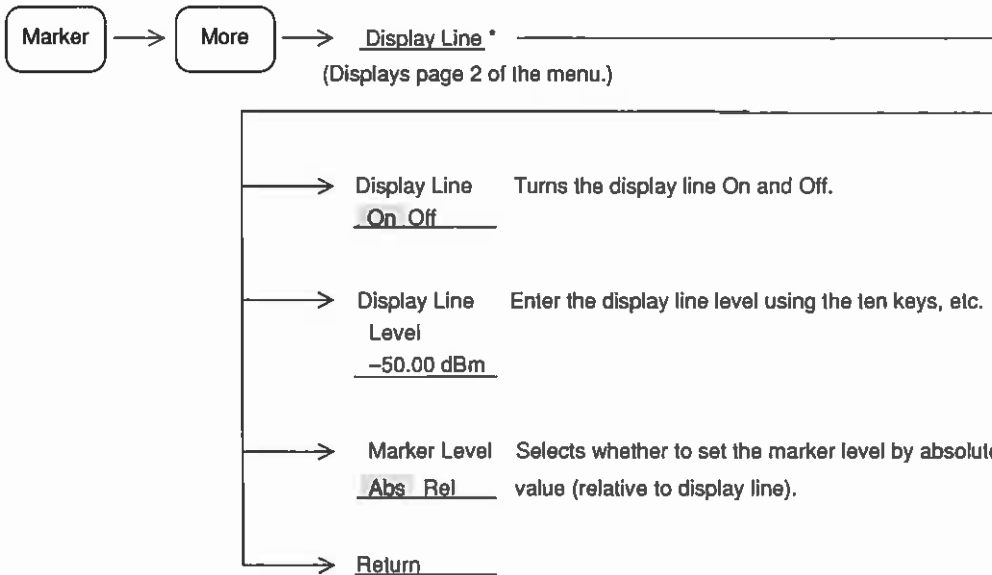

Display-line On and Off are common to all traces (A, B, BG, Time). Also, the display-line level is common to all traces (A, B, BG, Time).

The display-line level and Abs/Rel can be selected independently for each trace.

Zone Sweep and Signal Tracking

The spectrum analyzer has two sweep methods - zone sweep which sweeps only within the zone marker and a signal tracking function which detects the peak level frequency at each sweep, then moves it to the center of the zone marker.

Zone Sweep

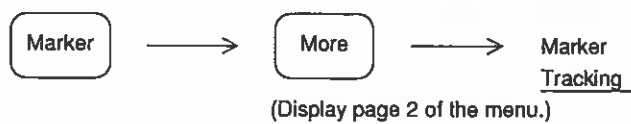

Zone sweep can be conveniently used to closely and quickly analyze part of the whole sweep range on the screen.

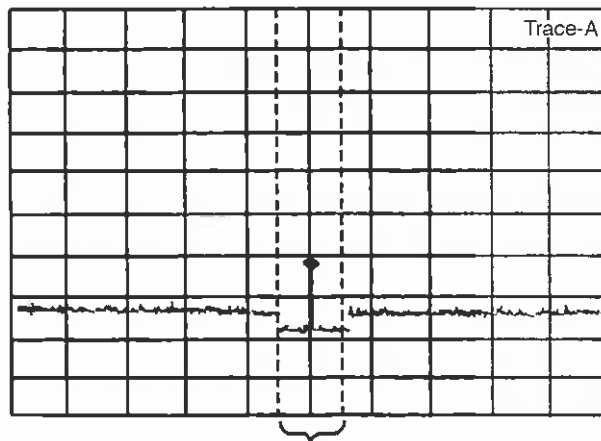

A signal masked by noise can be analyzed at high speed by setting zone sweep to On and adjusting the resolution bandwidth and video bandwidth.

Note: Zone sweep cannot be executed while the marker is Off or when the instrument is in the time domain mode.

When the multimarker function is on, Each multimarker in on state is sequentially zone-swept (multi-zone sweep).

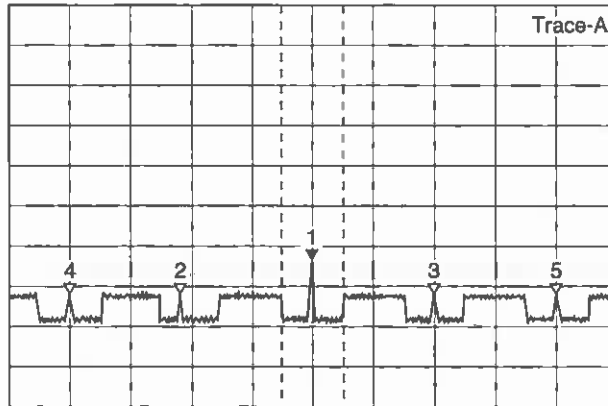

Signal Tracking



The signal tracking function moves the frequency of the signal of the peak level in the zone marker to the center of the zone marker at each sweep. This is convenient when tracking and analyzing a signal whose frequency drifts.

Note: The signal tracking function cannot be executed while the marker is Off or when the instrument is in the time domain mode.

Multimarker

The spectrum analyzer has a marker function which displays up to ten markers displayed simultaneously. Multimarker can be set by the following four methods:

- Highest 10
- Harmonics
- Marker List
- Manual Set

Highest 10 Multimarker

Allocates up to 10 multimarkers in descending order of signal peak level displayed on the screen.

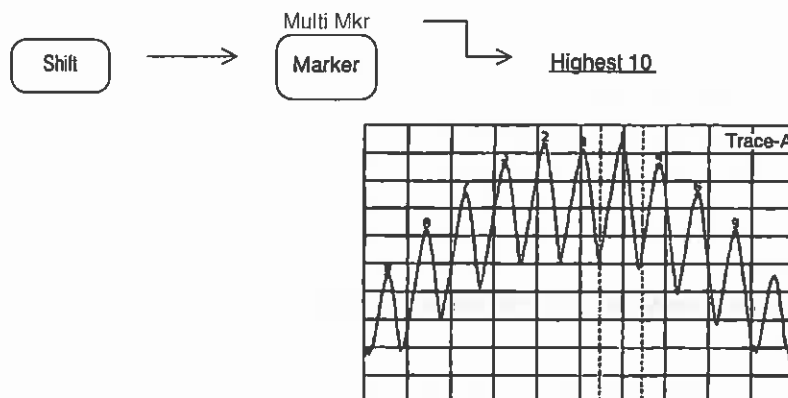

After executing Highest 10, an active marker (with the same functions as the current marker) moves to the peak point of the maximum level signal.

Note: Each multimarker has a zone as same as the current marker, and is positioned at the maximum level point. So, when the next sweep is done after Highest 10 operation, each multimarker position may be changed. To prevent this, execute the Highest 10 after stopping the sweeping or after narrowing the zone width.

Harmonics Multimarker

Allocates multimarkers to the 2nd to the 10th harmonic signals of the active marker signal as the fundamental signal.

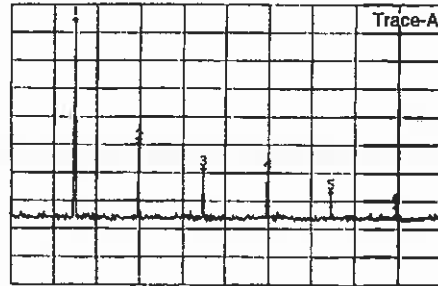

Note: If the fundamental and second harmonic signals are not separated by more than the marker zone width, or when there are larger level signals other than harmonic signals in the frequency range of the marker zone width centered at the harmonic signals, harmonic signals will be incorrectly detected. In this case, narrow the marker zone width.

Peak Hold Multimarker

Searches the signal peaks displayed on the screen, and then allocates multimarkers to the peaks of the max. Five nearest points to the current marker (as 5th) at the right and left each.

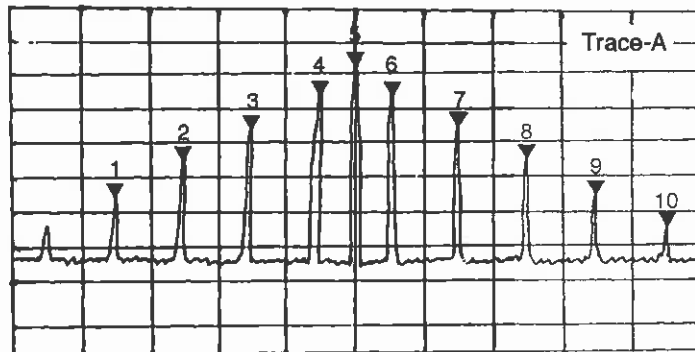

Note:

The multimarker has the zone, the same as the current marker. The multimarker searches the peak points within the zone. So, when the next sweep is performed after a peak hold execution, the new multimarker allocation may be changed. Use the peak hold function after stopping sweep, or with an enough narrow marker zone.

Marker List

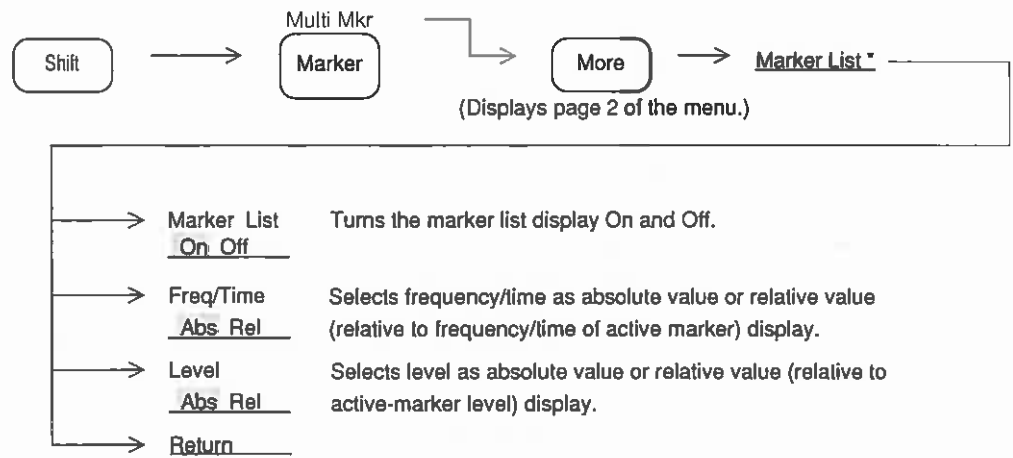

In Freq/Time Rel mode, frequency and time of the markers except active marker are displayed in relative values, and "R" marks are appended at the left.

In Level Rel mode, level of the markers except active marker are displayed in relative values.

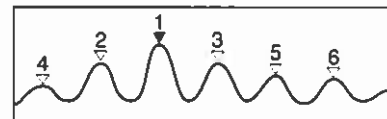

Marker List	
* 1:	1.00000GHz -15.12dBm
2:R	-1.31MHz -3.55dB
3:R	1.41MHz -3.61dB
4:R	-2.00MHz -5.96dB
5:R	1.89MHz -6.21dB
6:R	2.20MHz -6.76dB
7:	
8:	
9:	
10:	

Manual Set

Allocates up to 10 multimarkers to arbitrary frequencies or time points.

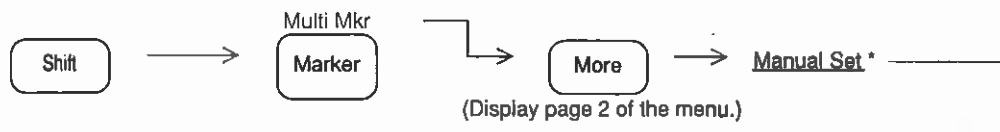

<ul style="list-style-type: none"> → → → → 	<p><u>Change Active Maker No</u> _____</p> <p><u>Select Marker</u> 1 _____</p> <p><u>On with</u> <u>Auto Select</u> _____</p> <p><u>Off with</u> <u>Auto Select</u> _____</p>	<p>Selects the active marker from among the markers that are currently On. Each time this key is pressed, the markers are scrolled and selected. #</p> <p>Specifies the marker number to be set to On or Off.</p> <p>At the same time the marker number selected above is set to On, the selected marker is made the active marker. If the selected marker is already On, the next higher marker number of the markers set to Off is set to On. By holding this key down, the multimarkers are set to On one by one in ascending order of number.</p> <p><Example> When marker No.4 is selected when marker No. 3, 4, 5, 8, and 9 are On, the markers are turned On in No., 6, 7, 10, 1, 2 order.</p> <p>Sets the marker of the selected No. to Off. If the selected marker is already Off, the next smaller marker No. of the markers set to On is set to Off. By holding down this key, the multimarkers are set to Off one by one in descending order of number. When the active marker is set to Off, the marker with the next smaller number is made the active marker.</p> <p><Example> When marker No. 7 is selected to be set to Off when marker No. 3, 4, 5, 8 and 9 are On and marker No. 5 is made the active marker, the markers are set to Off in No. 6, 5, 4, 3, 9 order, then marker No. 8 becomes the active marker.</p> <p># The active marker is indicated by the ▼ mark. The other marker Nos. are indicated by the ▽ mark. The active marker can be moved by using the ten keys, up-down keys, or rotary knob.</p>
--	---	--

Continued

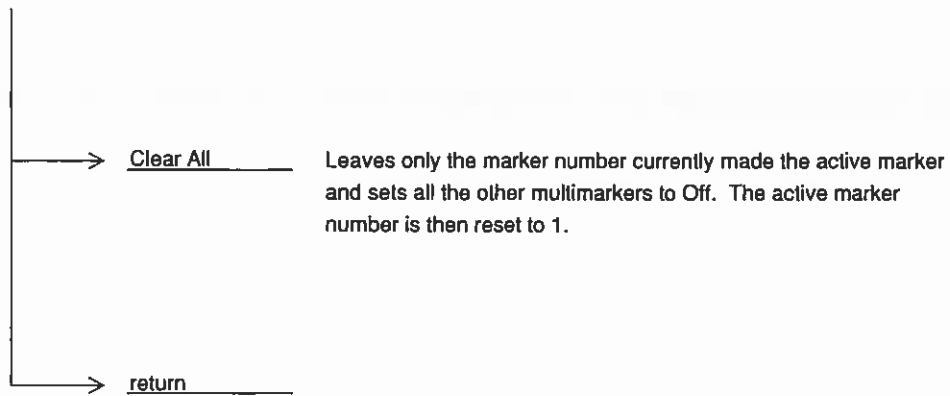

Displays the active marker value.

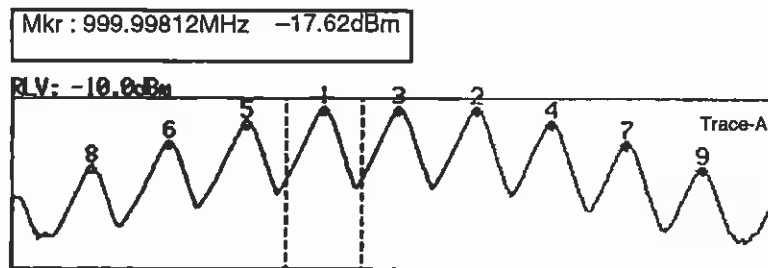

* indicates the active marker.

MARKER LIST		
* 1:	999.998 12MHz	- 17.62dBm
2:	1.000 002 12GHz	- 17.62dBm
3:	1.000 000 00GHz	- 17.89dBm
4:	1.000 004 00GHz	- 25.88dBm
5:	999.996 00MHz	- 25.89dBm
6:	999.994 00MHz	- 37.53dBm
7:	1.000 006 04GHz	- 37.53dBm
8:	999.992 00MHz	- 52.45dBm
9:	1.000 008 04GHz	- 52.49dBm
10:		

Undisplayed markers are set to Off.

Multimarker Off

To return from multimarker to normal marker, perform the following key operations:



Marker Search

The spectrum analyzer has the following four marker search functions:

- Peak search
- Next Peak search
- Dip search
- Next Dip search

Peak Search

Peak Search detects the maximum level point from the entire trace in which a marker is displayed and moves the marker to that point.

To Execute Peak search, perform the following key operations:

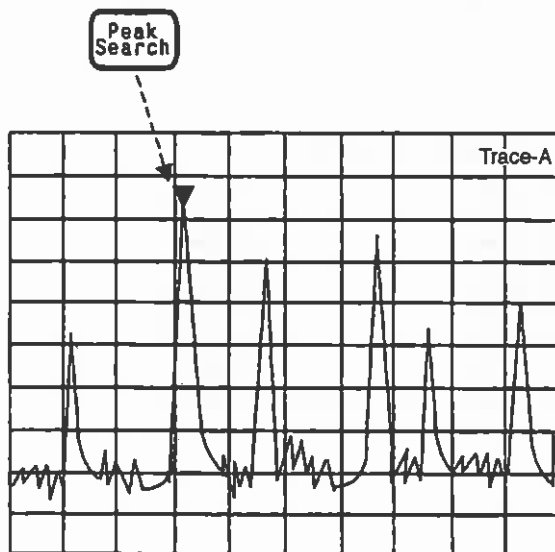

Next Peak Search

Next Peak Search detects the next largest peak relative to the current marker level and moves the marker to that point. (When there are two or more peaks with the same level on the screen, the leftmost peak is detected.)

Execute Next Peak search by performing the following key operations:

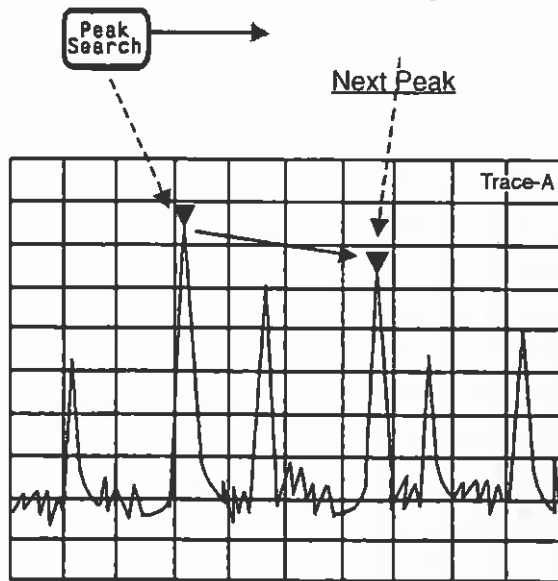

The next largest peaks can be detected and the marker can be moved to those peaks by executing Next Peak Search consecutively.

Dip Search

Dip search detects the minimum level point from the entire trace in which a marker is displayed and moves the marker to that point.

Execute Dip search by the performing the following key operations:

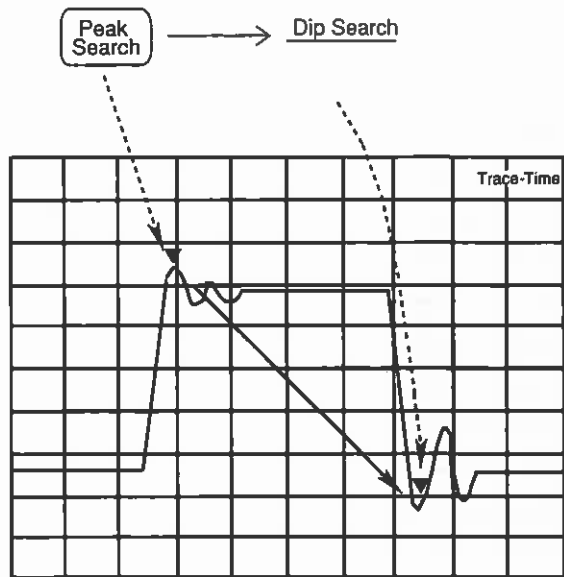

Time domain waveform

Next Dip Search

Next Dip Search detects the next smallest dip relative to the current marker level and moves the marker to that point. (When there are two or more dips with the same level on the screen, the leftmost dip is detected.)

Execute Next Dip Search by performing the following key operations:

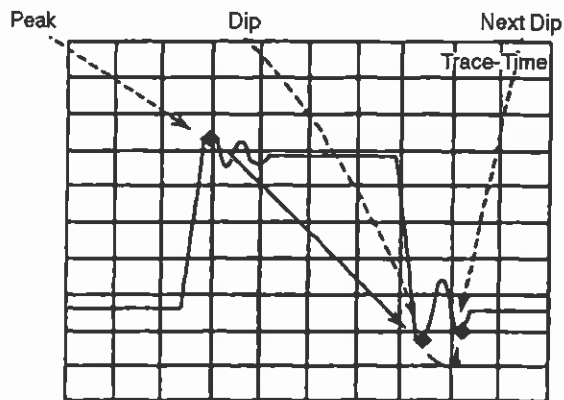
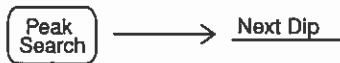

Time domain waveform

The next smallest peaks can be detected one by one and the marker moved to the detected peaks by executing Next Dip Search consecutively.

Setting Search Resolution

Sets the Peak and Dip search resolution. When searching for the next peak, etc., the marker moves to the point of the set resolution or higher.

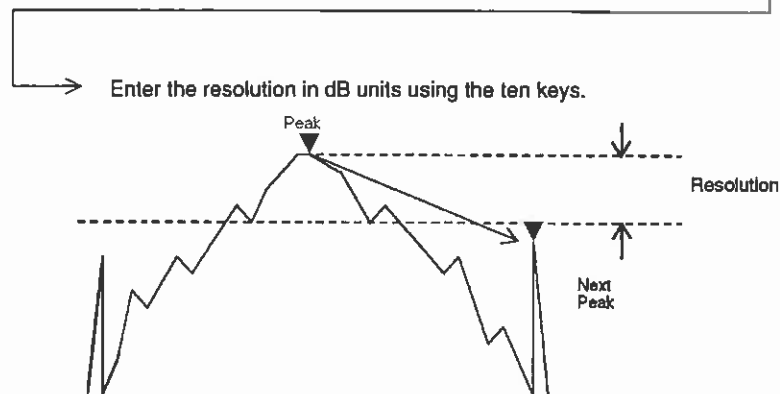
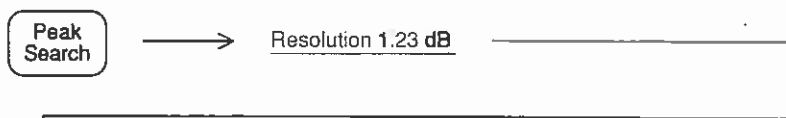

Setting Search Threshold

Sets the display line to the threshold and searches for the level above or below the display line.

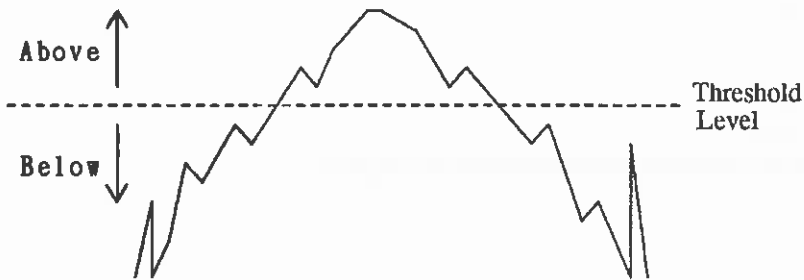
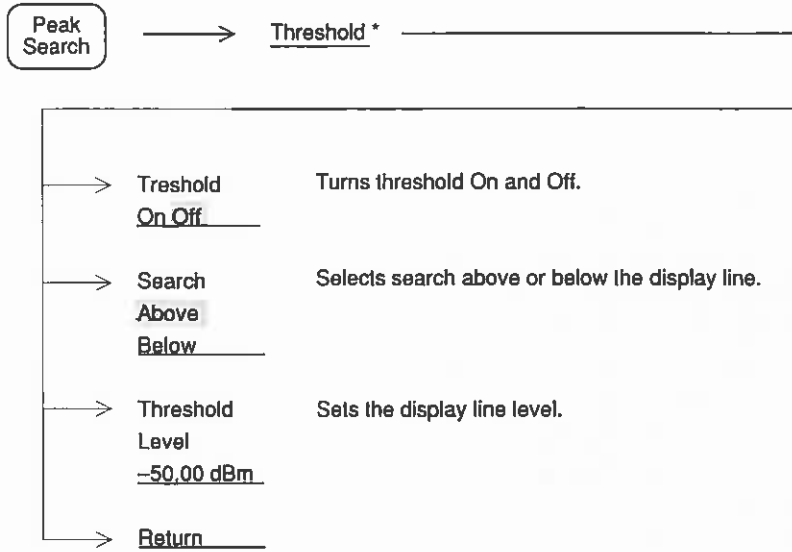

Setting Parameters Using Marker Values

The marker value can be set as the parameter value of the observation frequency, reference level, and so on. This facilitates observation of the desired waveform.

To set parameters using the marker value, the following settings are possible:

- Mkr → CF Sets the marker frequency to the center frequency.
- Mkr → RLV Sets the marker level to the reference level.
- Mkr → CF Step Size Sets the marker frequency to the center frequency step size.
- Delta Mkr → Span Sets the reference marker and current marker frequency to the start frequency and stop frequency, respectively.
- Zone → Span Sets the zone marker center frequency and zone width to the center frequency and frequency span, respectively.

In the time domain mode, only Mkr → RLV is valid.

Mkr → CF/Mkr → RLV

Sets the current marker frequency or level to the center frequency or reference level.

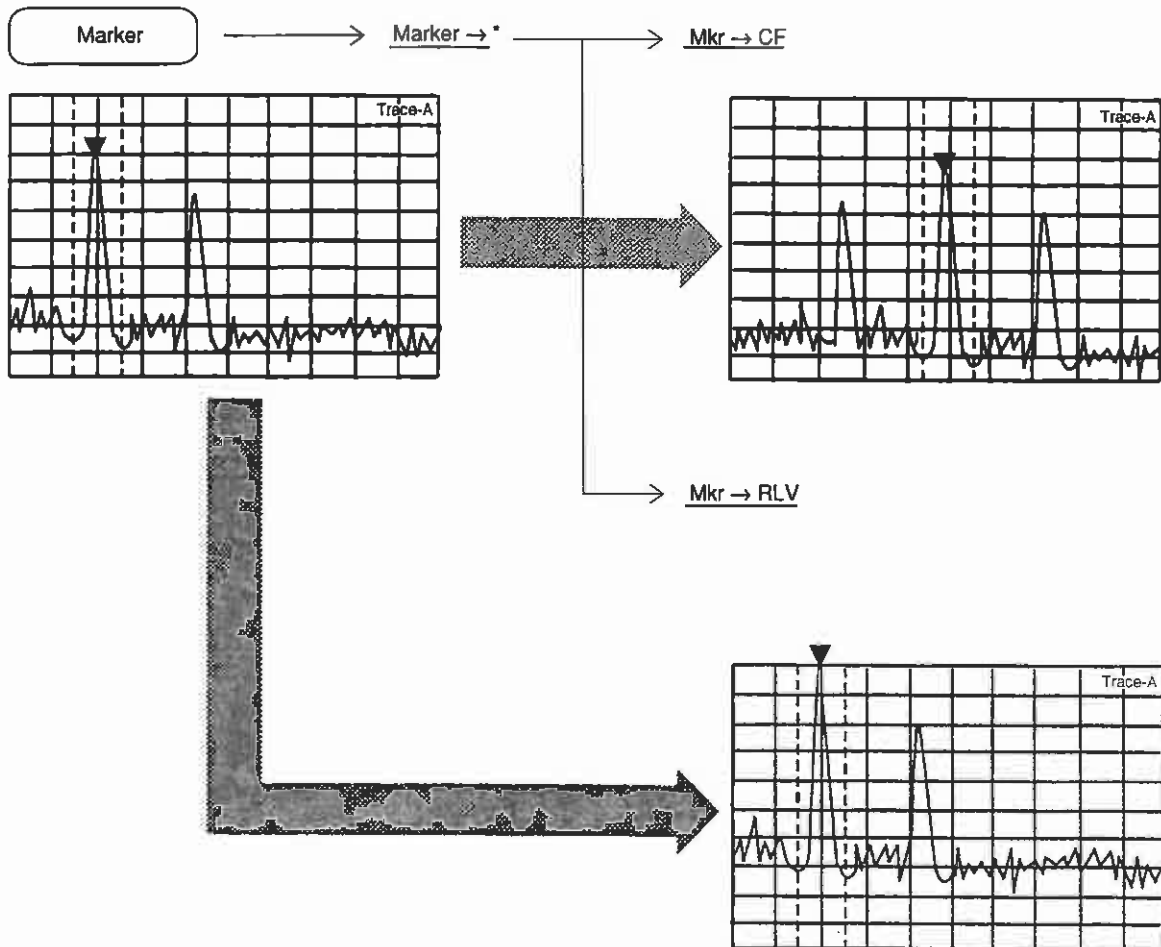

Mkr → CF Step Size

Sets the marker frequency to the center frequency step size (up-down keys resolution).

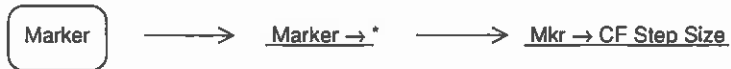

Although this action does not cause any change to appear on the screen, when the center frequency is changed with the up-down keys, the center frequency is changed with the marker frequency as the step size. This facilitates observation of harmonic waves.

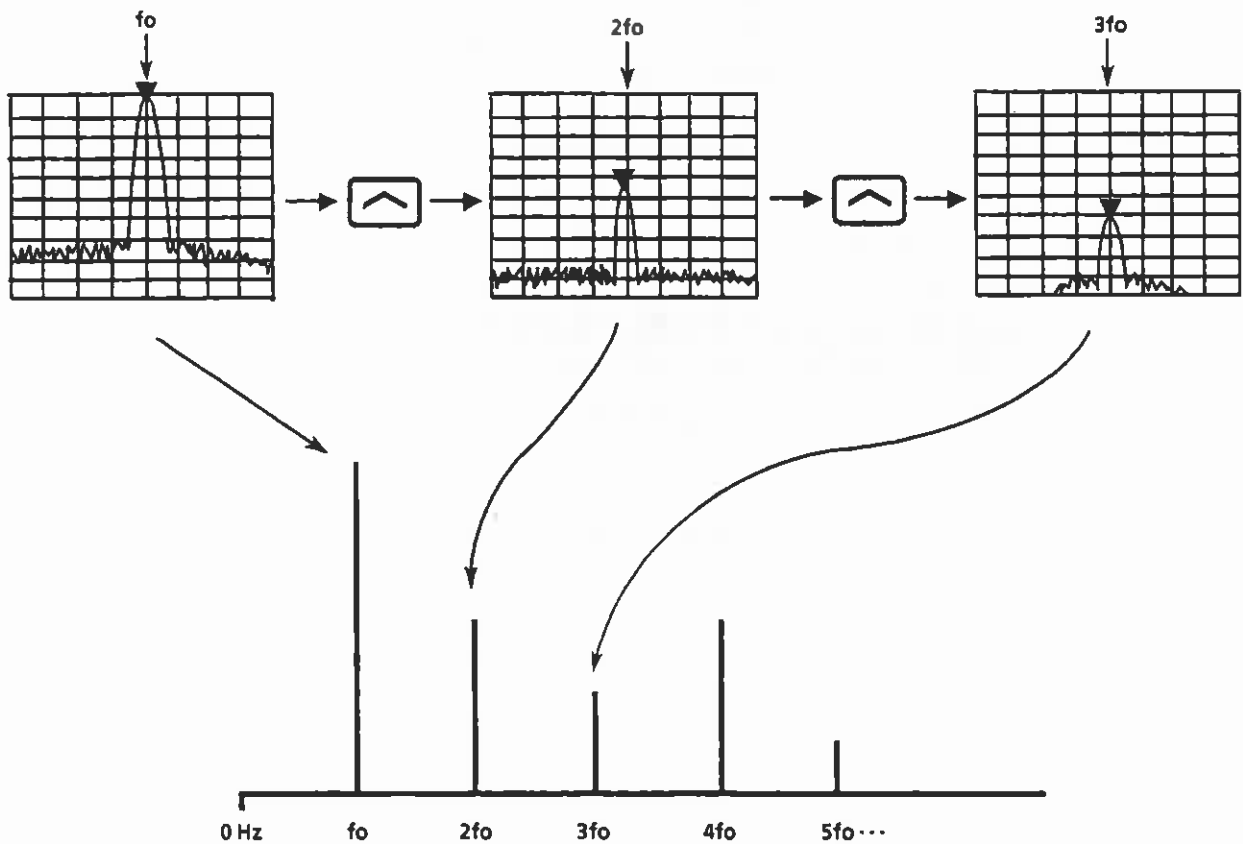

Delta Mkr → Span

In the delta marker mode, this operation sets the delta marker mode current marker frequency and reference marker frequency to the start frequency and stop frequency, respectively.

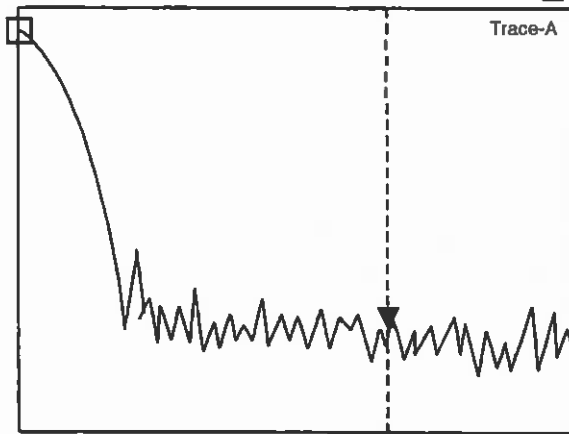
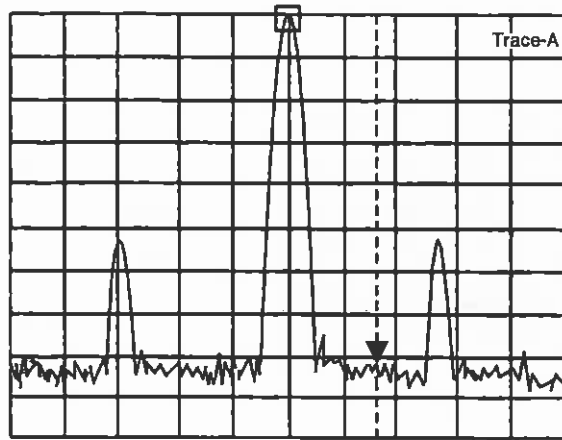
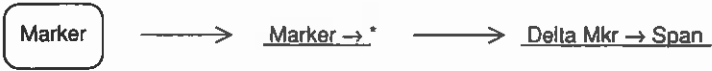

The normal marker position remains unchanged.

Since the reference marker is fixed relative to the frequency, it moves to the extreme left when the frequency span is changed.

Zone → Span

To set the zone marker center frequency and width to the center frequency and frequency span, respectively, perform the following key operations:

Marker → Marker → * → Zone → Span

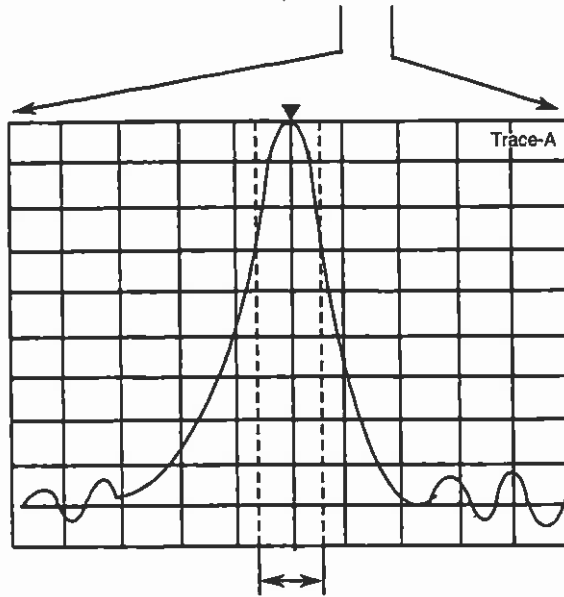
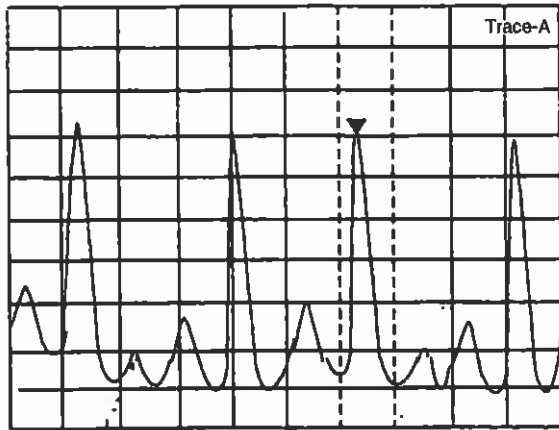

The zone width remains unchanged.

Section 4 Signal Search Function

Signal search facilitates extraction of the objective signal. Although the functions of signal search are similar to the marker function, this section only describes the Signal Search section.

Detecting Peaks	4-3
Detecting the Maximum Peak Signal by Automatic Tuning	4-4
Moving the Measurement Point	4-5
Peak → CF and Peak → RLV	4-6

Detecting Peaks

The spectrum analyzer has the following three peak detection functions:

- Auto Tune
- Zone Marker
- Marker Tracking

Section 3 “Marker Function” describes the Zone Marker function and Section 6 “Selecting the Sweep Method” describes the Marker Tracking function.

Detecting the Maximum Peak Signal by Automatic Tuning

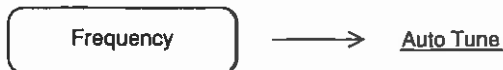

Pressing the Auto Tune key detects the maximum peak signal within the Back Ground (BG) and sets that signal frequency and level to the center frequency and reference level, respectively.

- Notes:
- When executed at a frequency span of more than 100 MHz, the frequency span is set to 100 MHz. When executed at a frequency span of less than 100 MHz, that value is retained.
 - The input attenuator is set to Auto.
 - In the initial state, the Auto Tune frequency range is set to 90 MHz to 3.0 GHz (MS2681A), 250 MHz to 7.8 GHz (MS2683A), 900 MHz to 30 GHz (MS2687A/MS2687B). By changing the trace BG frequency range, the Auto Tune frequency range can also be set as follows:

Start frequency

Start frequency specified in trace BG

However, except the 0 Hz to 3/100 frequency span range.

Stop frequency

Stop frequency specified in trace BG.

Moving the Measurement Point

This function moves the spectrum on the screen to the center to facilitate measurement. The following five functions are available:

- Mkr → CF Sets the marker frequency to the center frequency.
- Mkr → RLV Sets the marker level to the reference level.
- Peak → CF Sets the frequency of the maximum point on the screen to the center frequency.
- Peak → RLV Sets the level of the maximum level point on the screen to the reference level.
- Scroll→, Scroll← Scroll the observation frequency.

Section 3 “Marker Functions” describes the Mkr → CF and Mkr → RLV functions. Section 2 “Frequency/Amplitude Data Entry” describes the scroll function.

This section describes the Peak → CF and Peak → RLV functions.

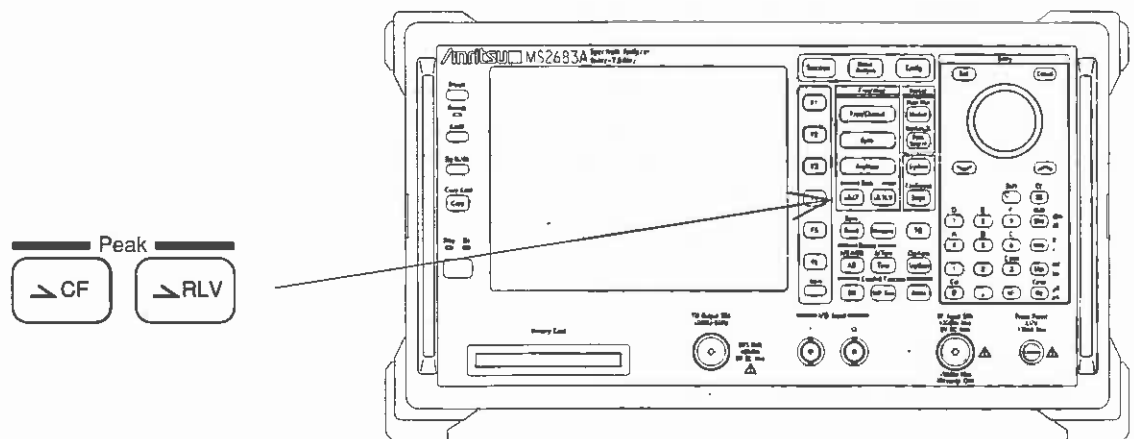

Peak → CF and Peak → RLV

The Peak → CF and Peak → RLV functions set the maximum level value displayed on the screen to the center frequency and reference level, respectively, and move the peak point to the center of the frequency axis on the screen and to the top level axis, respectively.

(1) Peak → CF

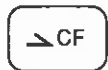

Sets the maximum peak point and the zone marker to the center frequency.

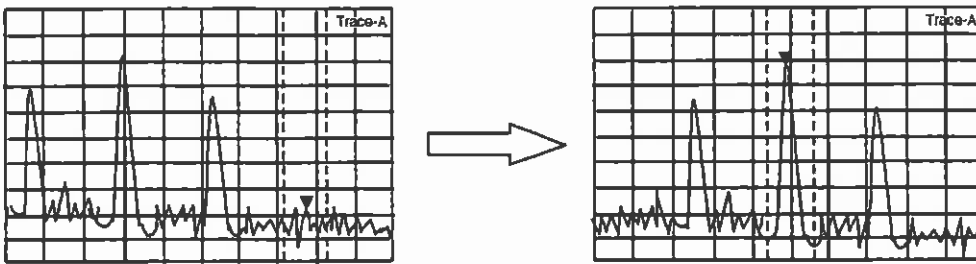

- Notes:
- When the frequency at the maximum peak point is less than 0 Hz, the center frequency is set to 0 Hz.
 - If there are two or more maximum peak points with the same level on the screen, the peak point with the lowest frequency is moved to the center frequency.
 - Peak → CF does not operate in the following cases:
 - [1] When zone sweep is On
 - [2] In the time domain mode
 - [3] When A<Time is specified in the A/Time mode

(2) Peak → RLV



Sets the maximum peak level to the reference level.

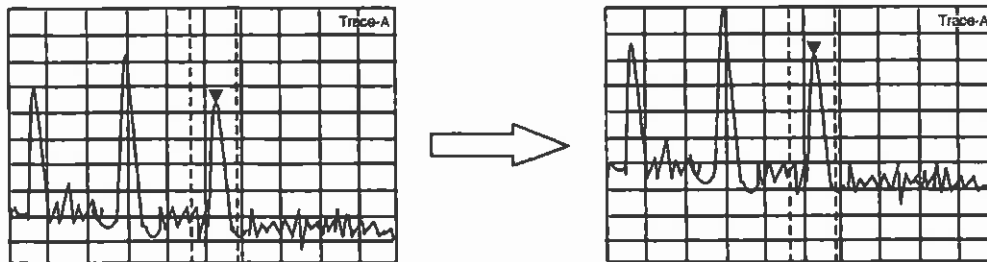

- Note:
- If the level at the peak point exceeds the permitted range for the reference level, the reference level is set to the maximum (minimum) reference level that can be set.
 - If the level at the peak point exceeds the reference level (scale over), one operation of the Peak→RLV may not be able to set the correct reference level. In this case, repeat the Peak→RLV operations a few times.

Section 5 Selecting the Display Method

This section gives a detailed description of the display modes (Trace A/B, A/B, A/BG, Trace Time, A/Time), storage modes (Normal, Max Hold, Min Hold, Average, View, Cumulative, Overwrite), detection modes (Normal, Pos Peak, Sample, Neg Peak) and time domain analysis.

Display Mode	5-3
Trace A	5-5
Trace B	5-6
Moving the Trace	5-6
Trace Computation	5-7
Trace A and Trace B Overwrite Display	5-8
Setting Active Trace	5-8
Trace A/Trace B Top and Bottom Split Display	5-9
Setting Sub-trace Sweep	5-10
Trace A/Trace BG Top and Bottom Split Display	5-11
Trace Time	5-12
Trace A/Trace Time Top and Bottom Split Display ..	5-14
Storage Mode	5-15
Setting Storage Mode	5-17
Averaging Function	5-18
Max Hold and Min Hold Functions	5-21
Detection Mode	5-22
Selecting Detection Mode	5-23
Selecting Measured Level by Detection Mode	5-24
Setting Trace Point	5-25
Time Domain	5-26
Setting Time Domain	5-26
Setting Time Span	5-27
Time Domain Expanded Display	5-28

The spectrum analyzer can display four trace modes (BG †, A, B, Time) in six Display modes (A, B, Time, A/B, A/BG, A/Time).

In the Display mode, the two keys of the Display section shown below are used.

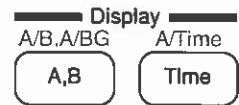
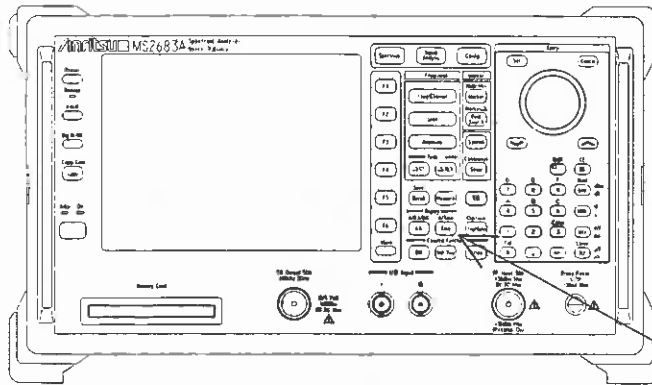

Display Mode

The following outlines the trace modes. The figure on the next pages shows the correlation between trace modes.

- Trace BG When the objective signal is measured in the trace A, B, or Time mode, the trace BG mode allows the frequency range to be observed to be pre-set to a wide band. The BG band is initially set to full span (0 to 3 GHz/7.8 GHz/30 GHz).
- Trace A, trace B Used to analyze signals in the normal frequency domain. The BG zone within trace BG is expanded and displayed. Different frequency range can be observed by Trace A and Trace B.
- Trace Time Displays the time axis waveform at the center frequency of trace A.

† BG (Back Ground)

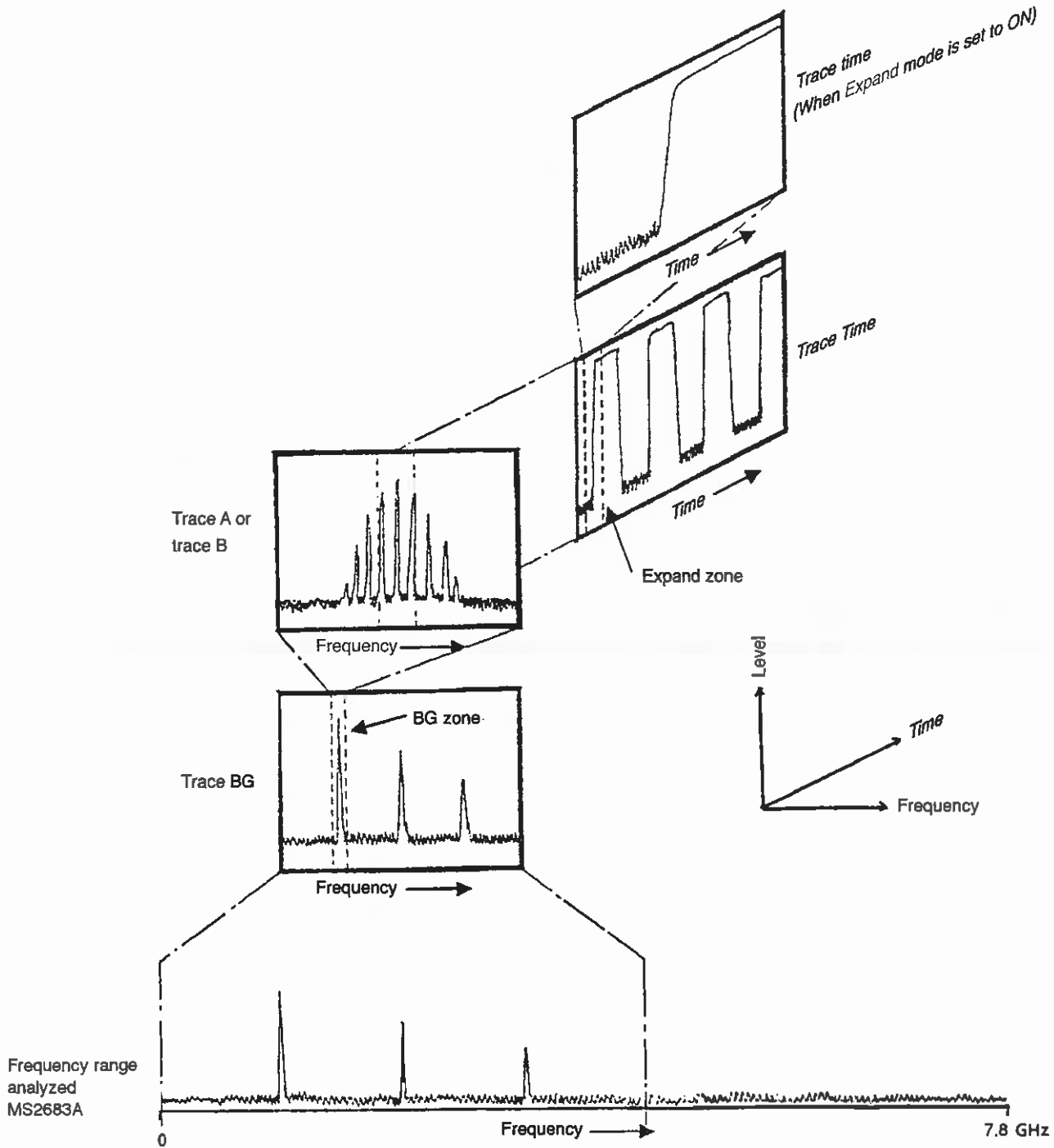

Trace A

Trace A is used to analyze signals in the normal frequency domain.

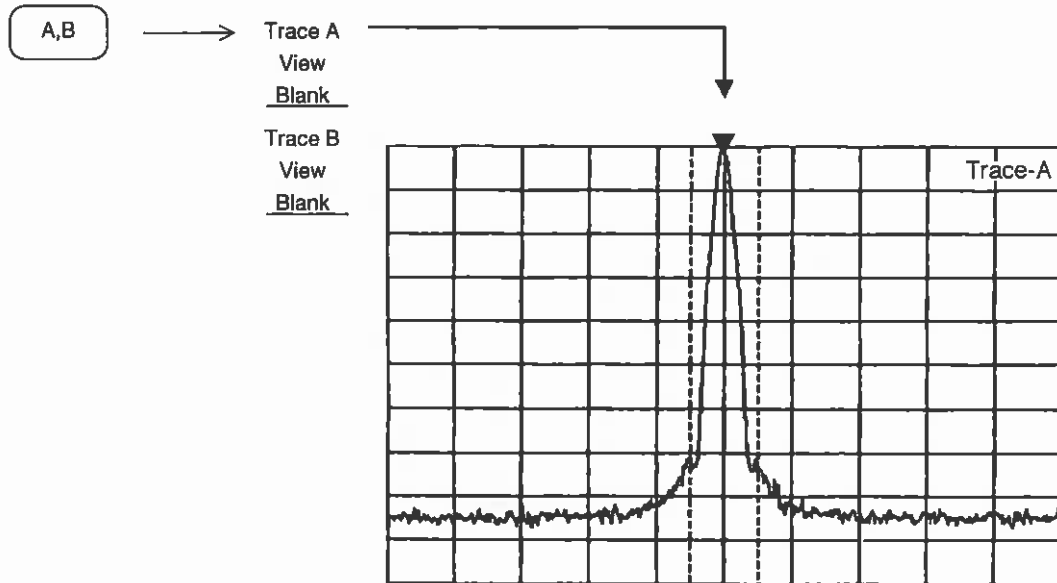

Trace B

Like trace A, trace B is used to analyze signals in the normal frequency domain. When used with trace A, it is possible to compare waveform A and waveform B.

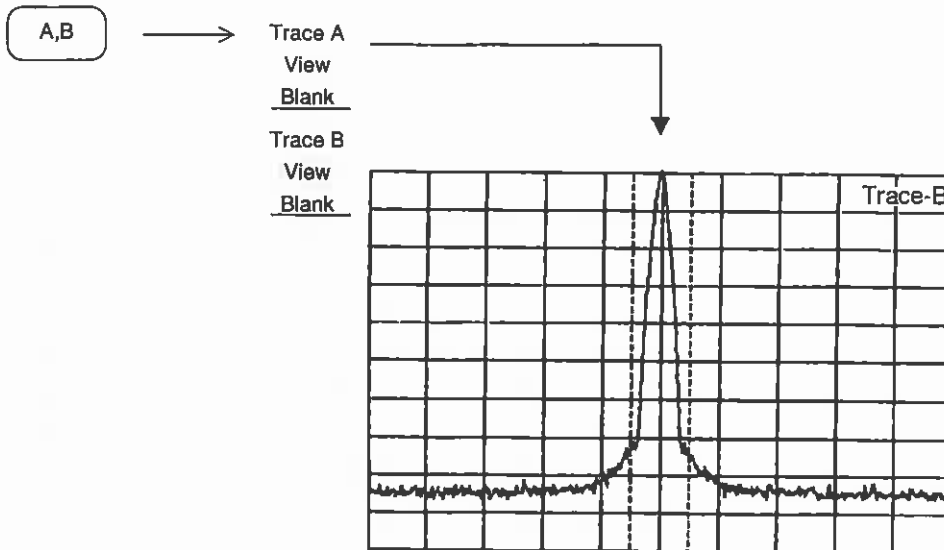

Parameters of the trace A and trace B can be set independently.

Moving the Trace

This function moves and adds the trace A and trace B displays once.

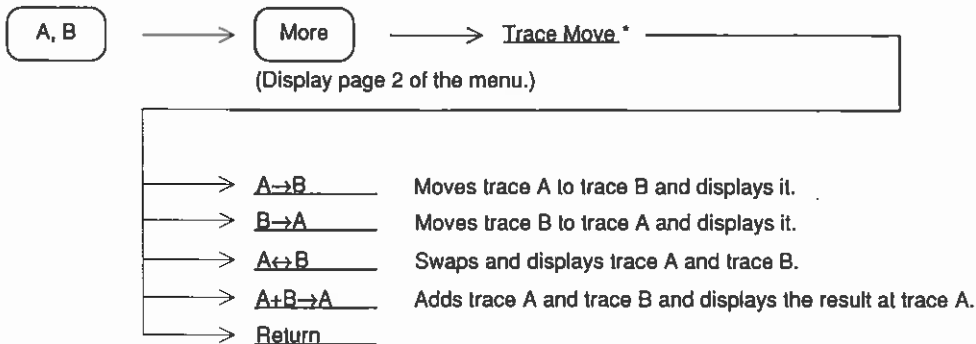

Set the move-destination-trace storage mode to View, and stop the sweeping before moving the trace. If the trace A or trace B threshold is set to any other mode, the trace data will be displayed once, then updated.

Trace Computation

This function continuously displays the difference between trace A and trace B. Normally set trace B to the View mode before executing this function.

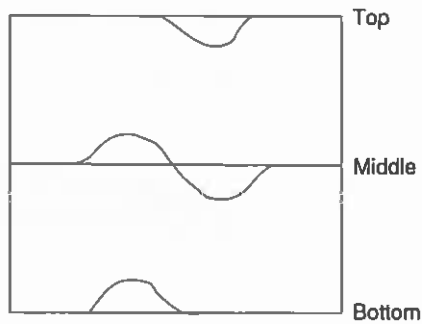
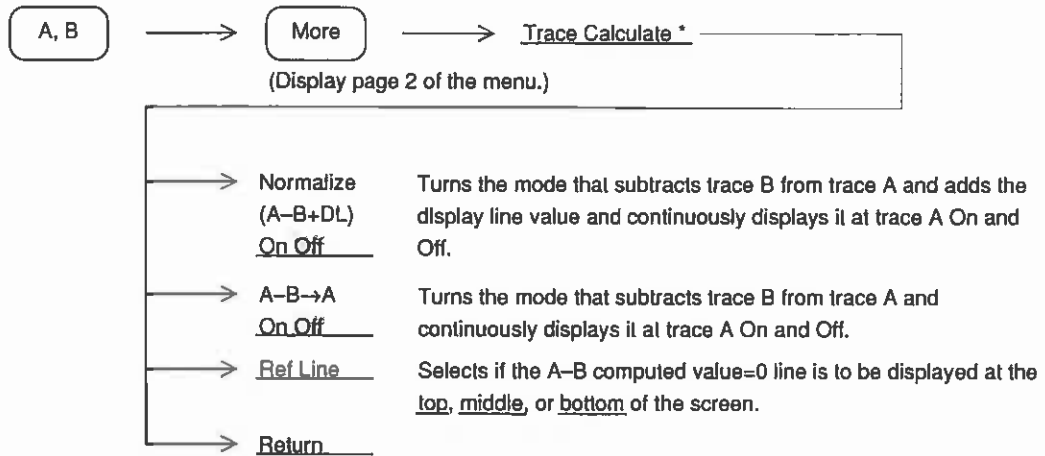

Trace A and Trace B Overwrite Display

Overwrites trace A and trace B on one screen. At this time, the trace B frequency range, reference level, and other parameters are the same as trace A.

However, in the threshold mode and detection mode, the parameters can be set independently at trace A and trace B. For instance, comparison measurement with a standard waveform and simultaneous observation of the same waveform in a mode different from the normal mode and max hold (or averaging, etc.) mode are possible.

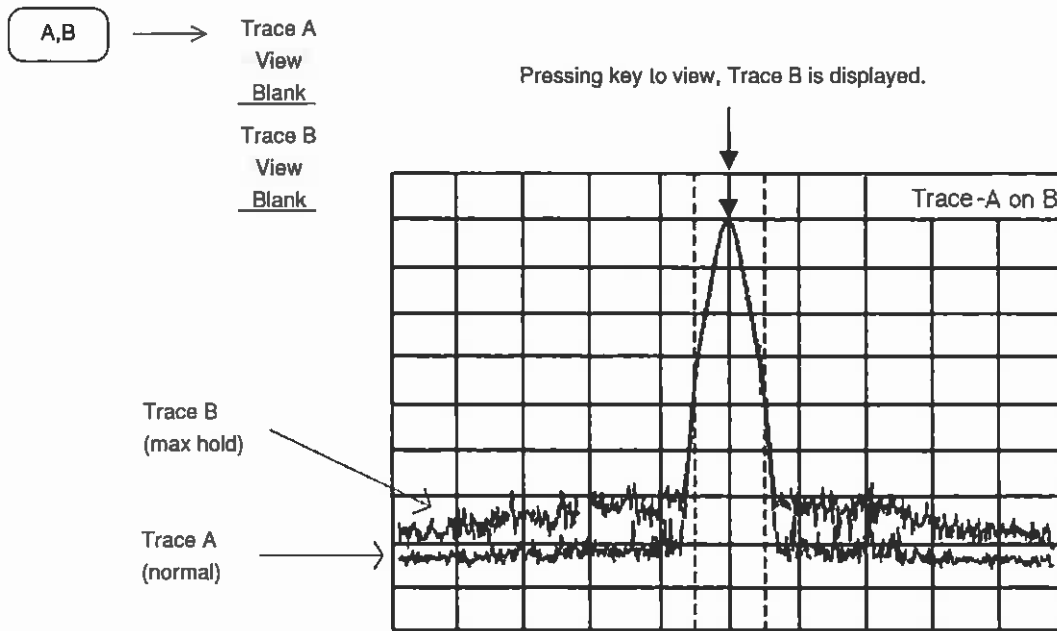

Setting Active Trace

When trace A and trace B were overwritten on the same screen, select the marker trace by pressing this key.

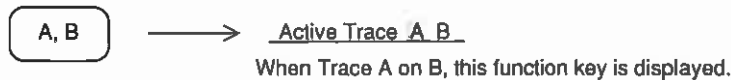

Trace A/Trace B Top and Bottom Split Display

When trace A and trace B are overwritten and displayed, the setup parameters are common. In this mode, however, the frequency, reference level, and other parameters can be set independently.

For instance, the reference wave can be observed at trace A and harmonics can be simultaneously observed at trace B.

When examining interference, the frequency that is the source of the interference and interference of a different frequency that is generated by the effect of the source frequency can be simultaneously observed.

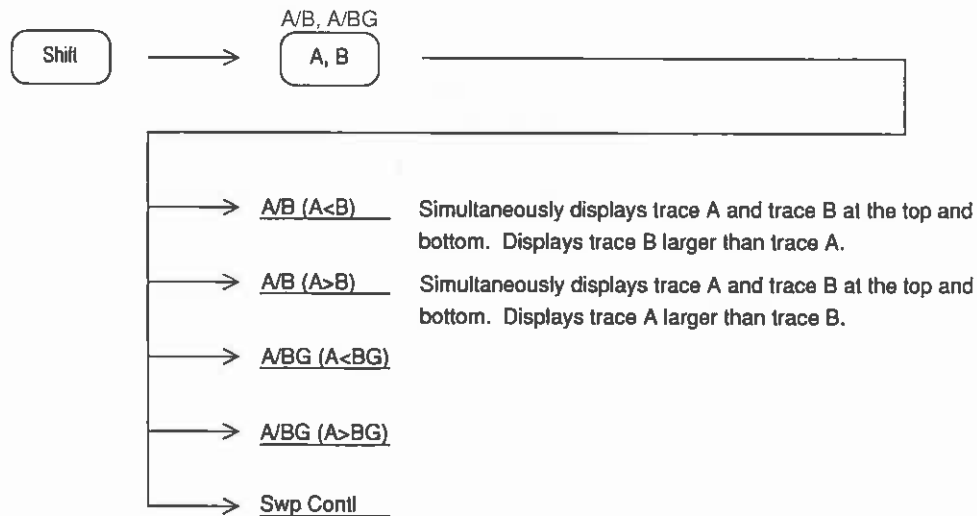

- The large display is called the main trace and the small display is called the sub-trace.

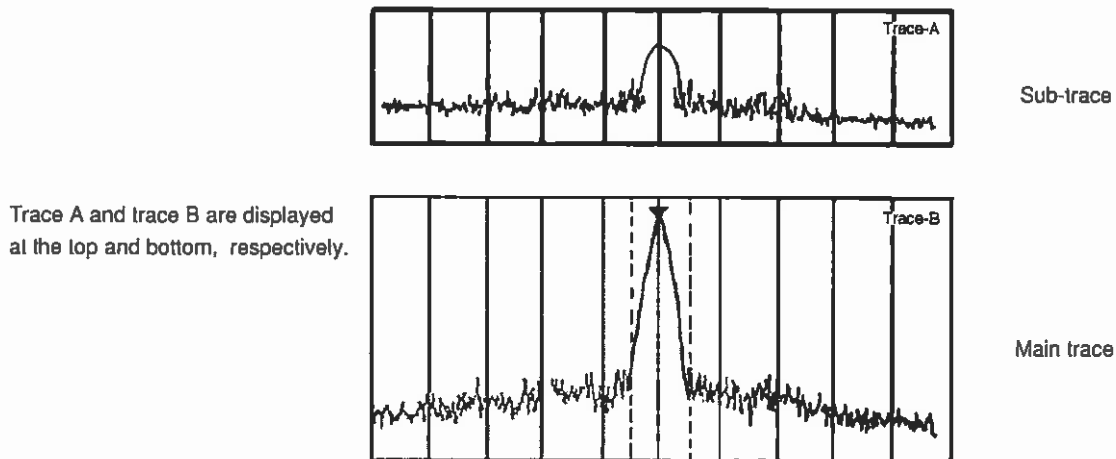

For A/B (A<B)

Setting Sub-trace Sweep

To set the sub-trace storage mode, perform the following key operations.

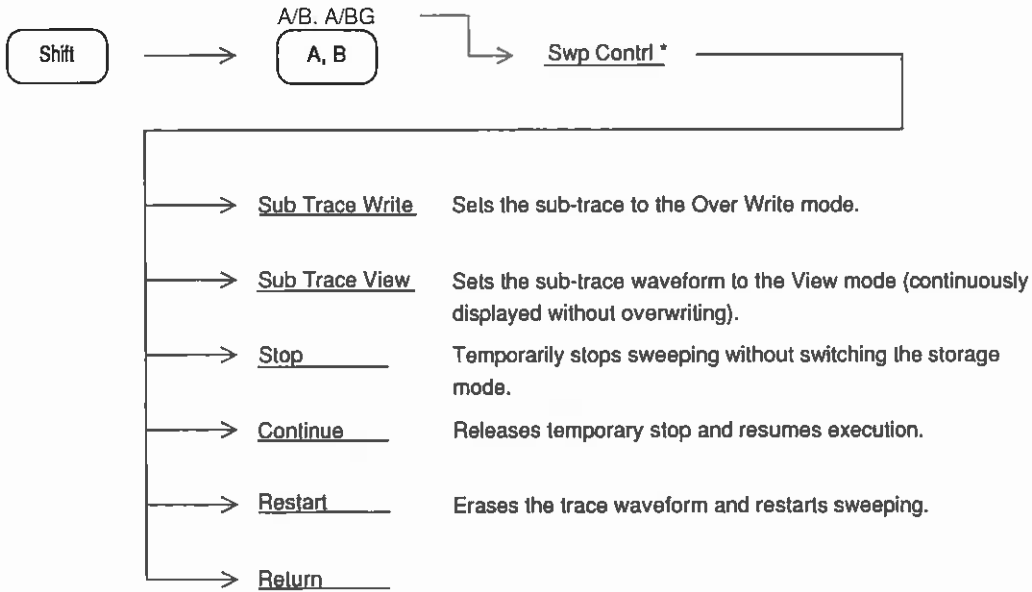

Trace A/Trace BG Top and Bottom Split Display

This mode simultaneously displays trace A and trace BG. It is used to extract a specific signal from a wide frequency range.

The conditions over a wide surrounding frequency range can be monitored while simultaneously observing the selected signal in detail.

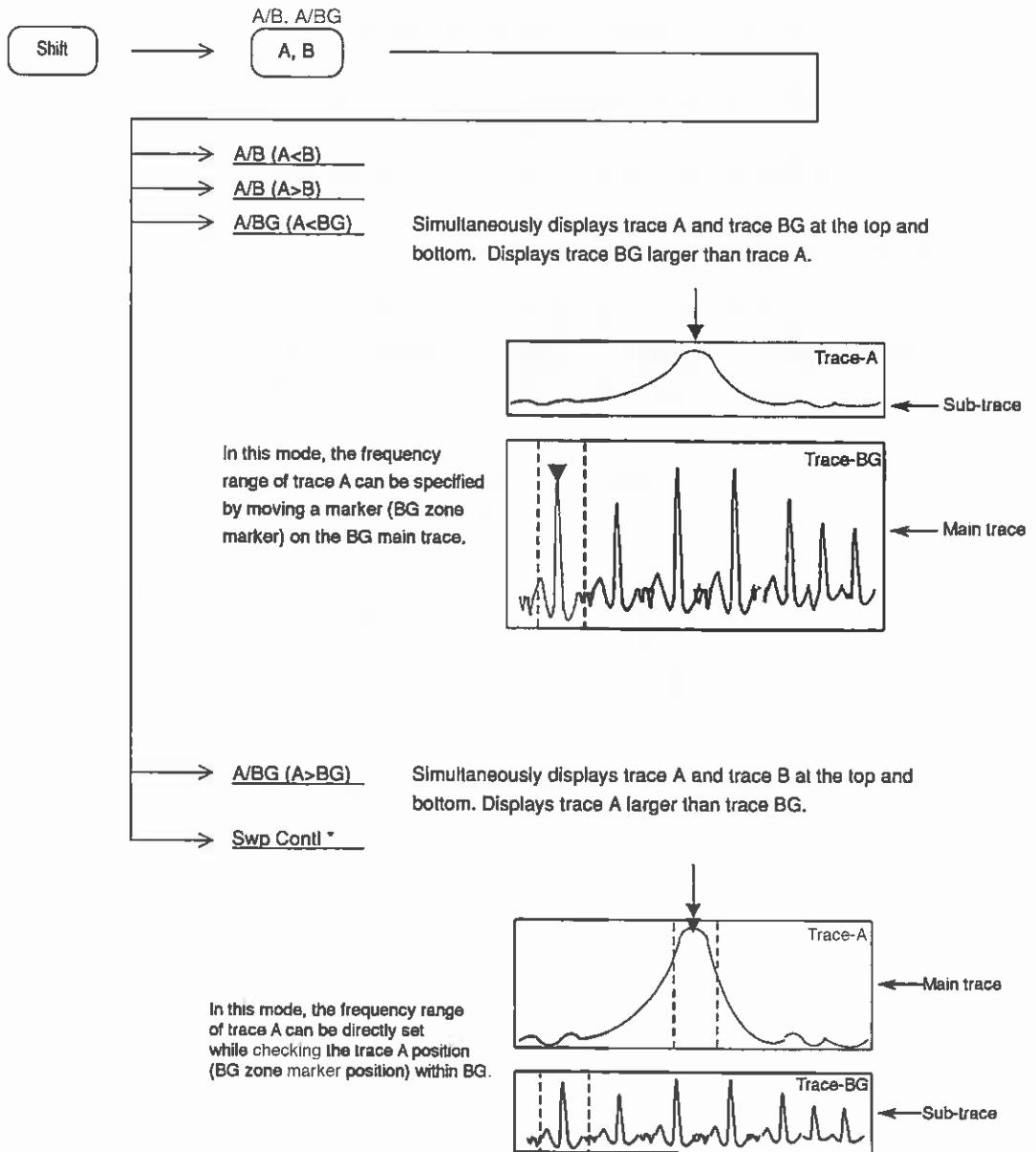

Trace A and trace BG parameters other than reference level, vertical axis scale, and input attenuator settings are used independently. Each parameter can be set in the main trace (larger displayed side).

Marker operation is available only for the main trace.

Trace Time

Trace Time displays the time axis waveform at the center frequency of trace A or trace B. To display trace Time, press the **Time** key.

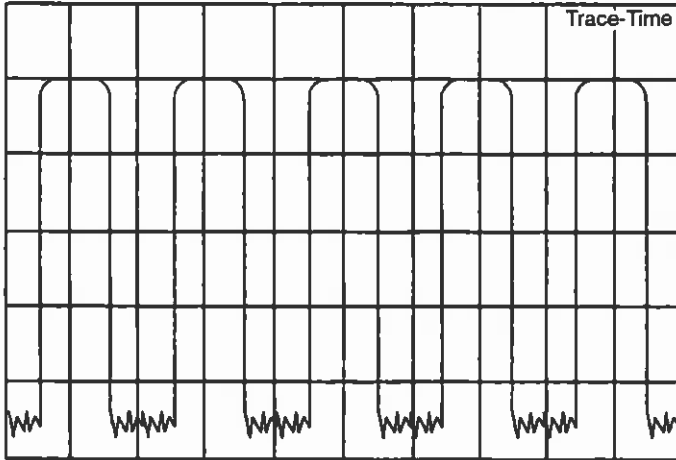

<div style="border: 1px solid black; border-radius: 10px; padding: 2px 10px; display: inline-block;">Time</div>	→	<u>Delay Time</u> <u>10,0 ms</u>	Sets the delay time from trigger to sweep. When a negative value is input, the waveform before the trigger is displayed up to one screen. (Refer to paragraph "Delay Time" in Section 6.)
	→	<u>Time Span</u> <u>200 us</u>	Sets the time span (time domain sweep time).
	→	<u>Expand*</u>	Expands and display part of the time domain waveform.
	→	<u>Storage *</u>	Selects the storage display mode.
	→	<u>Detection *</u>	Selects the detection mode.

Trace-A center frequency and Trace-Time tuning frequency is always common. Other parameters can be set independently. However, the following parameters can be used commonly by “Coupled function common/independent setting mode” described in Section 7.

- Resolution bandwidth (RBW)
- Video bandwidth (VBW)
- Sweep time (Sweep Time/Time Span)

Trace A/Trace Time Top and Bottom Split Display

Trace A/Trace Time top and bottom split display simultaneously displays trace A and trace Time.

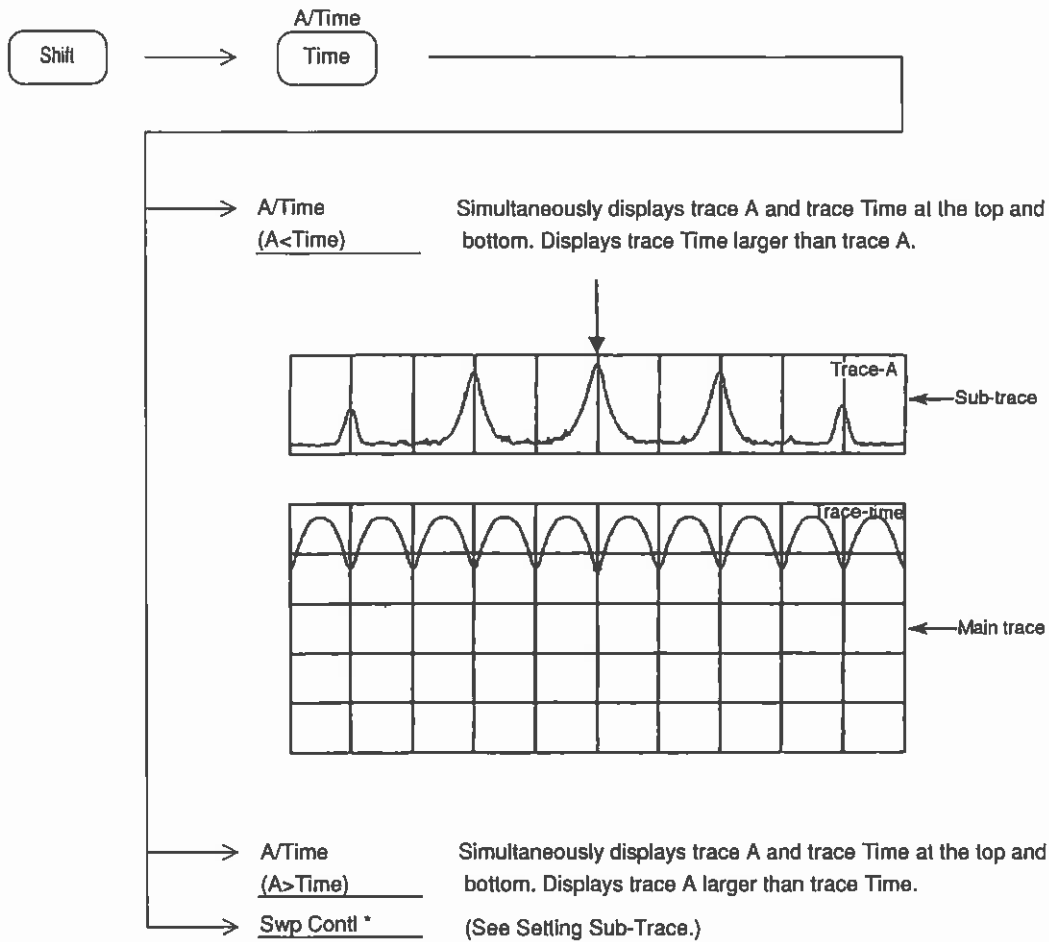

Each parameter can be set in the main trace (larger displayed trace). However, for common parameters (center frequency, reference level, input attenuator, and when system setting is coupled mode resolution bandwidth, video bandwidth, etc.), the sub-trace parameters can also be changed even when setting is performed at the main trace. Marker operation is available only for the main trace.

Storage Mode

The following seven storage modes can be selected for Display modes trace A, trace B, and trace Time.

Types of Trace Modes (1/2)

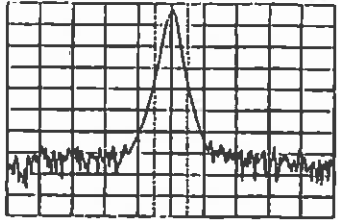
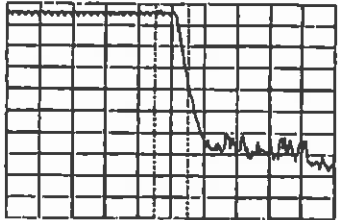
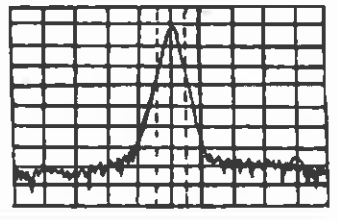
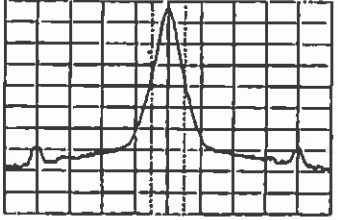
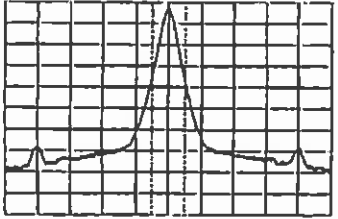
NO.	Mode	Explanation	Display example
1	Normal	Refreshes and displays the trace data at each sweep. This is used for normal measurement.	
2	Max Hold	At each sweep, compares the new trace data with the old data at each X axis point, then displays the larger value data. It is used to record a frequency-drifting signal.	
3	Min Hold	At each sweep, compares the new trace data with the old data at each X axis point, then displays the smaller value data.	
4	Average	At each sweep, calculates the average data at each X axis point, then displays the averaged results. This mode is used to improve the S/N ratio. For further details on the averaging function, refer to page 5-18.	
5	Linear Average	In the log display mode, equalization processing in linear value is performed and a result is displayed by the log. It is effective in signal measurement of the letter of a burst.	

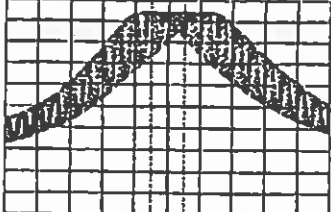
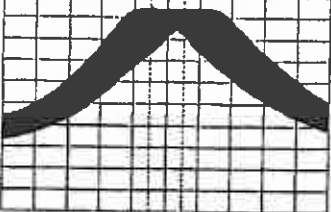
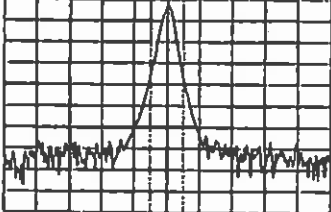
NO.	Mode	Explanation	Display example
6	Cumulative	Displays the cumulative waveform at each sweep. The waveform data, which are not connected by lines, are displayed by plotting the data.	
7	Over write	Displays the waveform overwritten without deleting the old trace data.	
8	View	Continues displaying the waveform as it is, without refreshing the currently-displayed trace data. This mode is used to observe waveforms with the trace data stopped temporarily.	

Setting Storage Mode

The storage mode can be selected by operating the function keys shown below while the spectrum analyzer is operating in the trace A, trace B, or trace Time mode.

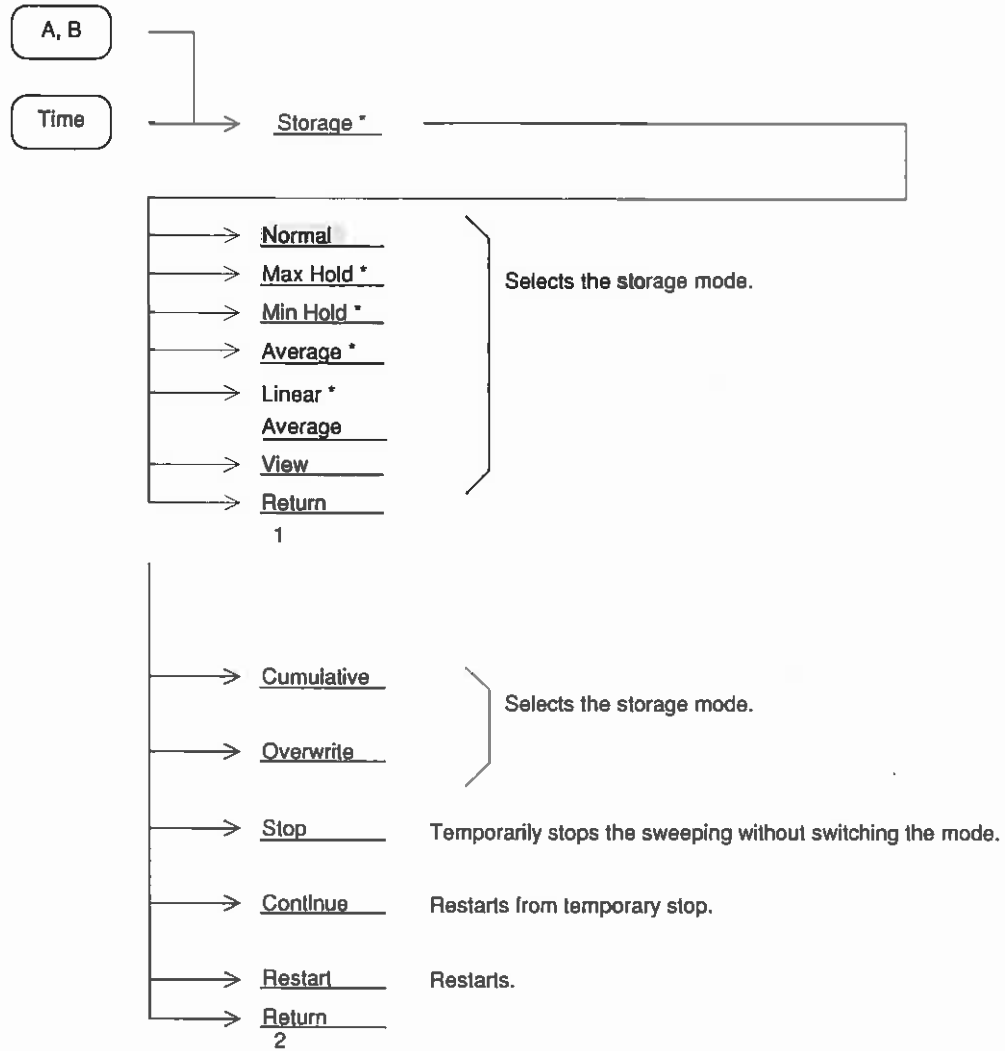

(Display page 2 of the menu by pressing the More key.)

Averaging Function

The digital averaging function calculates the average data at each X axis point at each sweep and displays the results. It is executed by selecting Average in the trace A, trace B, and trace Time display modes.

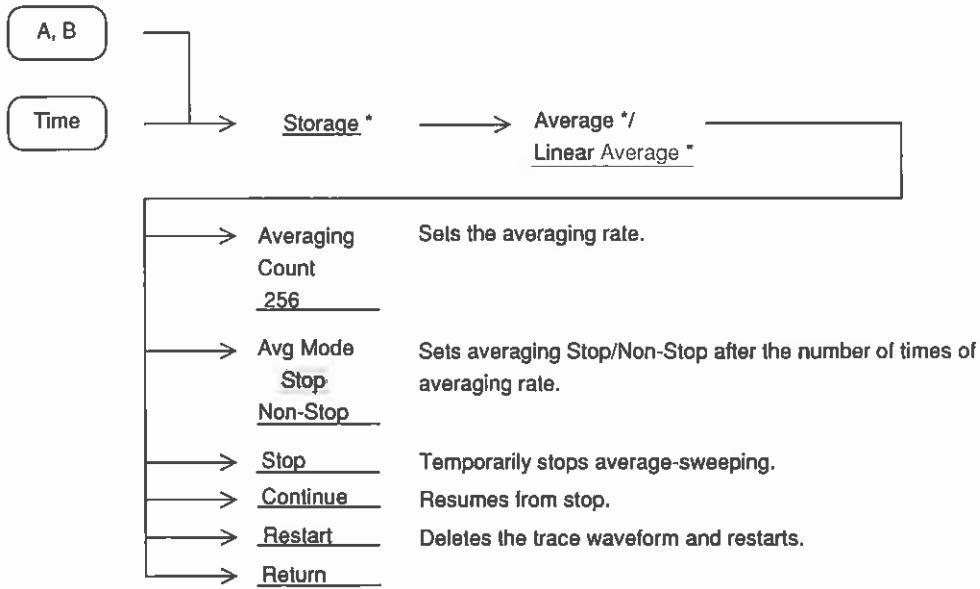

The averaging function improves the S/N ratio depending on the averaging rate and the number of sweep repetitions as shown on the next page.

Digital video averaging is performed by the method shown below.

Averaging Rate = N

	Number of Sweep repetitions	Measurement value	Displayed value
[3] Restart ↓	1	M (1)	Y (1) = M (1)
	2	M (2)	$Y (2) = Y (1) + \frac{M (2) - Y (1)}{2}$
	3	M (3)	$Y (3) = Y (2) + \frac{M (3) - Y (2)}{3}$
	⋮	⋮	⋮
	N-1	M (N-1)	$Y (N-1) = Y (N-2) + \frac{M (N-1) - Y (N-2)}{N-1}$
[1] Stop ↓	N	M (N)	$Y (N) = Y (N-1) + \frac{M (N) - Y (N-1)}{N}$
[2] Continue ↓	N + 1	M (N+1)	$Y (N+1) = Y (N) + \frac{M (N+1) - Y (N)}{N}$
	N + 2	M (N+2)	$Y (N+2) = Y (N+1) + \frac{M (N+2) - Y (N+1)}{N}$
	⋮	⋮	⋮

- [1] Sweep stops after N repetitions. (When Avg Mode is Stop)
- [2] The above stop condition is released by restarting sweep by Continue. The averaging operation resumes, while counting the number of sweep repetitions as N+1, N+2....
- [3] When Restart is performed during sweep or Stop, averaging is repeated from sweep count 1.

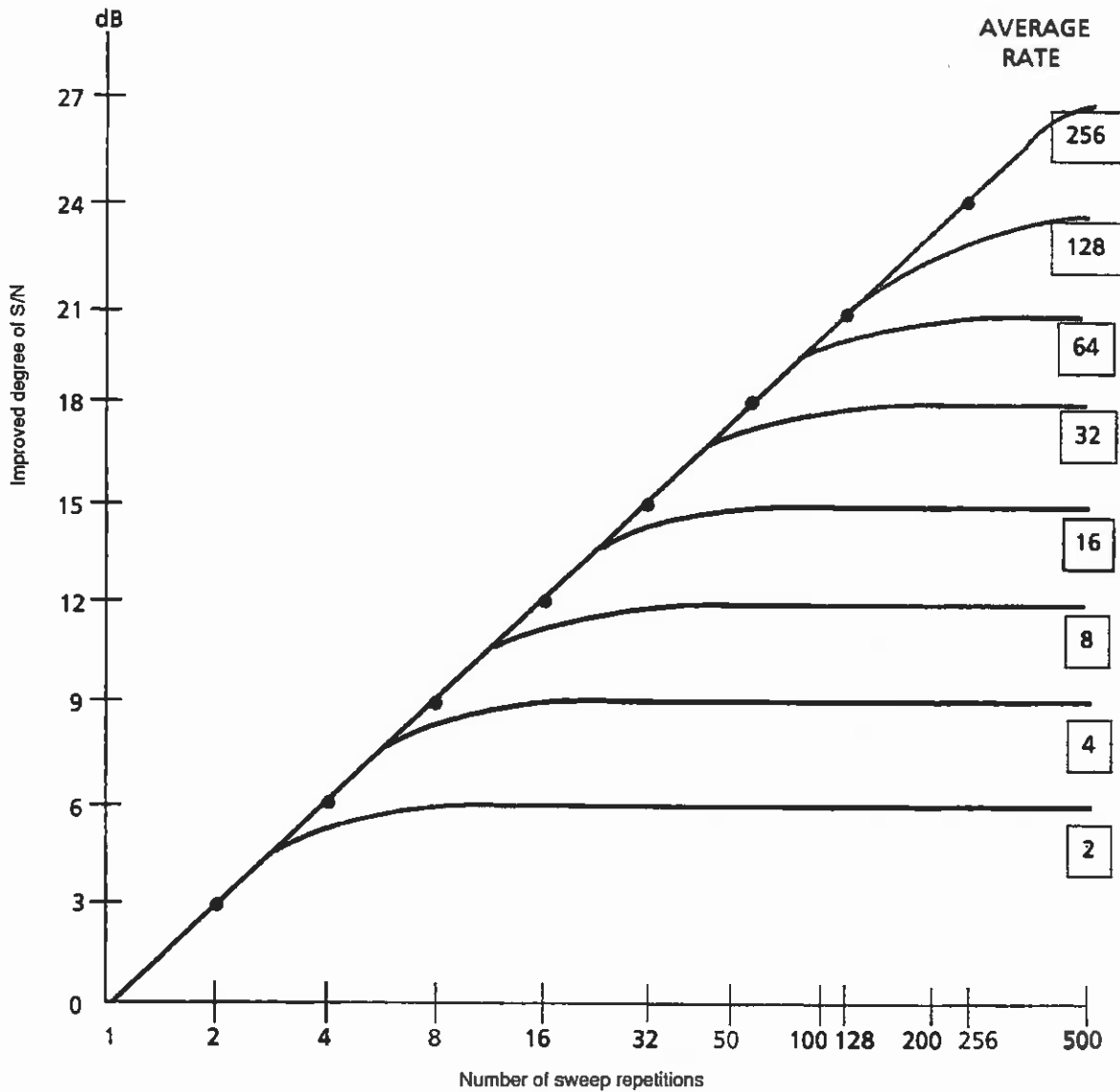

S/N Improvement by Digital Video Averaging

Averaging by video filter has the disadvantage that the sweep time becomes longer when the video bandwidth is narrowed to improve the averaging effect.

On the other hand, digital video averaging smoothes the trace display by averaging the digital data after A/D conversion at each sweep, without narrowing the video bandwidth (VBW). Since the video bandwidth (VBW) gets comparatively wider and the time required for each sweep can be shortened, the entire spectrum image can be verified quickly and the repetitive sweep can be stopped when the required smoothing has been obtained. The problem of averaging with the video filter is that the time required for each sweep becomes longer and it takes a long time to verify the entire spectrum image.

Since the averaging rate is initially eight, the above figure shows that an S/N improvement of 9 dB is obtained with eight sweeps.

Max Hold and Min Hold Functions

When Max Hold or Min Hold is selected, the sweeping can be performed by the number of specified repetitions, and then stops.

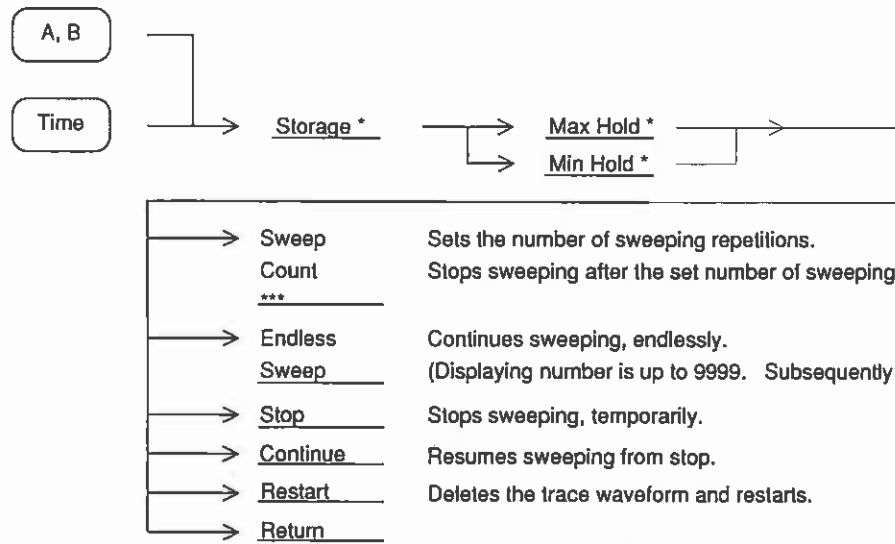

Detection Mode

The detection mode can be selected from among Normal, Pos Peak, Sample, and Neg Peak for trace A and trace B.

Normal	Traces the maximum value and minimum value between sample points.
Pos Peak	Traces the maximum value between sample points.
Sample	Traces the instantaneous value between sample points.
Neg Peak	Traces the minimum value between sample points.
Average	Traces the averaging value between display points.
rms	Traces the execution value between display points. It is effective at the time of Option 04 Digital Resolution Bandwidth use.

However, trace BG is fixed at Pos Peak.

When the time span is under 5 ms at trace Time, only Sample is available.

Selecting Detection Mode

Select the detection mode for trace A, trace B, or trace Time by performing the following key operations:

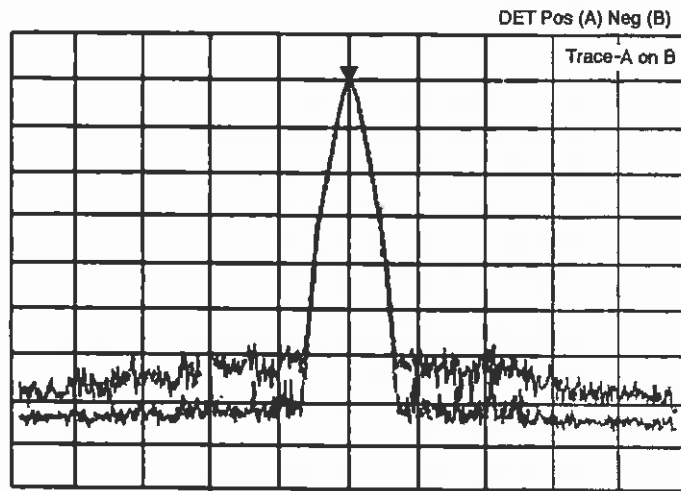
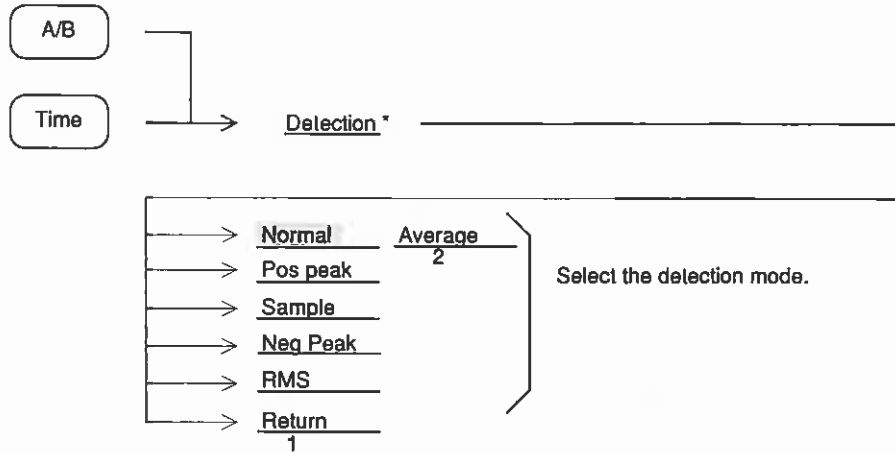

Waveforms when trace A is in the Pos Peak mode and trace B is in the NegPeak mode

Selecting Measured Level by Detection Mode

The spectrum analyzer has 501 or 1001 horizontal-axis measurement sample points. This corresponds to 501 or 1001 storage trace memories.

The detection mode determines what type of measured value should be stored in the trace memory at each measurement sample point.

Detection mode	Description
Normal	Stores both the maximum level and the minimum level present between the current sample point and the next sample point and displays them on the screen. This mode is used in normal measurement.
Pos Peak	Holds the maximum level present between the current sample point and the next sample point, then stores the maximum value in the trace memory corresponding to the current sample point. Pos Peak is used to measure the peak value of signals near the noise level.
Sample	Stores the instantaneous signal level at each sample point to the trace memory. Sample is used for noise level measurement, time domain measurement, and other measurements.
Neg Peak	Holds the minimum level present between the current sample point and the next sample point, then stores the minimum value to the trace memory corresponding to the current sample point. The Neg Peak mode is used to measure the lower envelope side of a modulated waveform.
RMS	Displays the root mean square (RMS) value between the current display point and the next display point. (This function is available when the Option 04 Digital RBW is installed.)
Average	Averages the AD sample values between the current display point and the next display point in Linear scale (Log is converted to Linear). When measures the C/N and noise, improve the measurement speed to conventional sample detection.

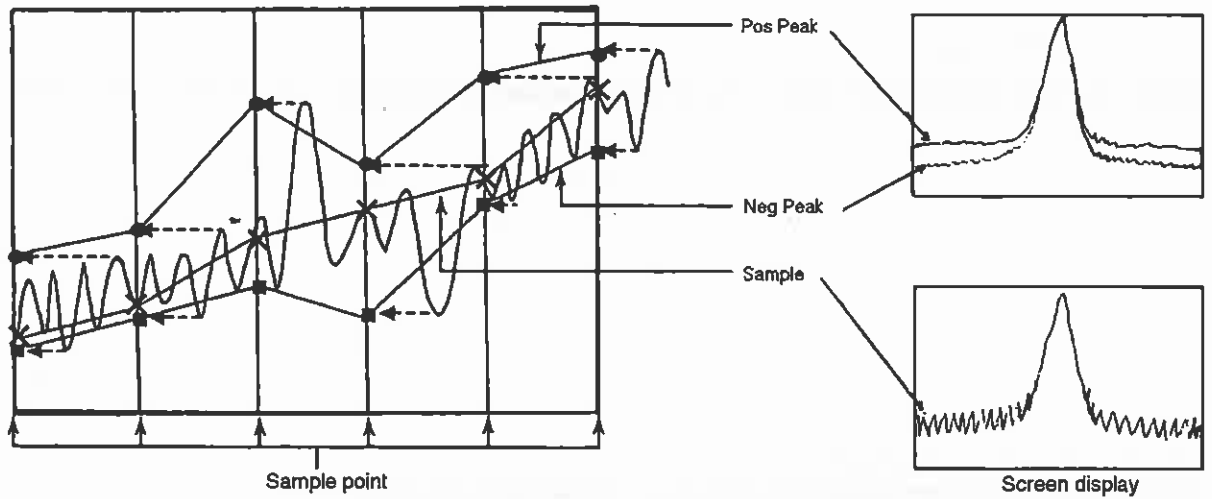

Note: When the detection mode is set to Sample or Neg Peak while the frequency span and resolution bandwidth are set so that the spectrum is displayed as discrete vertical lines, the spectrum peak is incorrectly displayed.

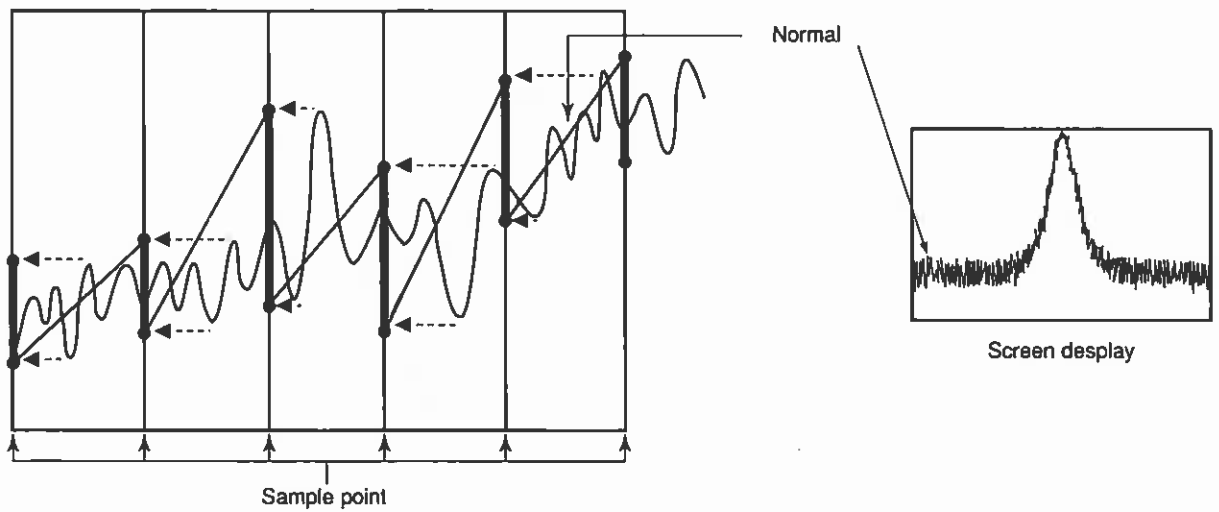

Normal traces and displays both Pos Peak and Neg Peak.

Setting Trace Point

System



Datapoints
501
1001

Sets the number of sample points of a horizontal axis to 501 or 1001.

Time Domain

Since the spectrum analyzer stops sweeping the frequency when set to a frequency span of 0 Hz, the spectrum analyzer becomes a selective level meter that continues to receive only the center frequency. In this case, the horizontal axis of the time-axis sweep waveform is graduated in time and displayed on the spectrum analyzer screen. This display method is called "time domain display".

The spectrum analyzer time domain display has an Expand function for expanding the waveform time axis to create a more convenient display. It also has a special function for monitoring an FM demodulated waveform.

Setting Time Domain

The time domain can normally be set by pressing the **Time** key in the Display section. It can also be set by setting the frequency span to 0 Hz in the frequency domain mode.

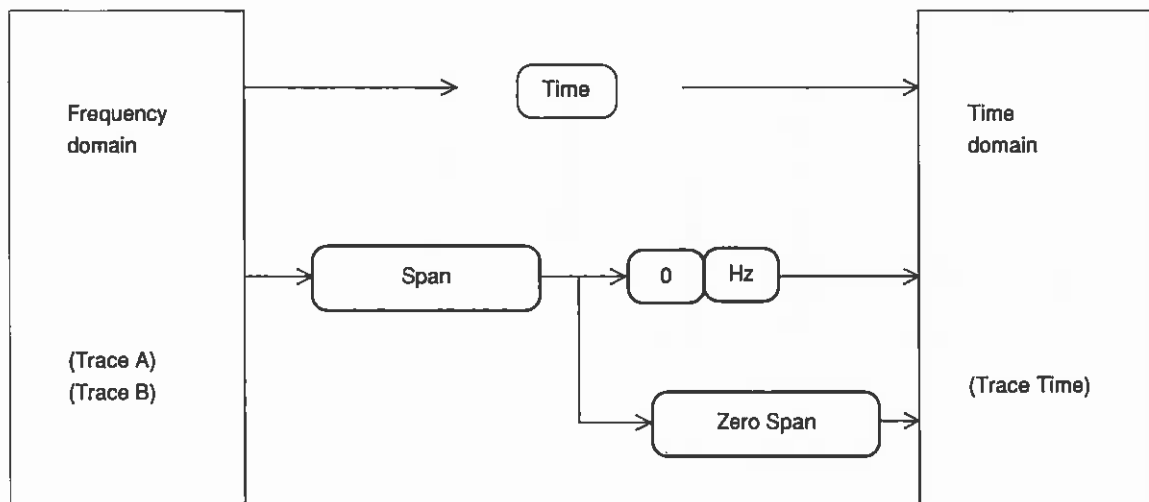

The following parameters can be set independently in the frequency domain or time domain mode:

- Vertical scale mode (Log/Lin)
- Vertical scale range (10 dB/div, 10%/div, etc.)
- Storage mode (Normal, Max Hold, Average, etc.)
- Detection mode (Pos Peak, Sample, Neg Peak, Normal, Average)
- Resolution bandwidth (RBW)
- Video bandwidth (VBW)
- Sweep time (Sweep Time/Time Span)
- Trigger switch (Freerun/Triggered)

The three parameters resolution bandwidth, video bandwidth, and sweep time can be selected in common or independently in the frequency domain or time domain mode when setting the system.

Note: The time domain mode marker function uses a spot marker. A zone marker cannot be used.

Setting Time Span

In the time domain mode, the measurement range on the horizontal axis does not set the frequency span, but sets the time span. To set the time span, perform the following key operations:

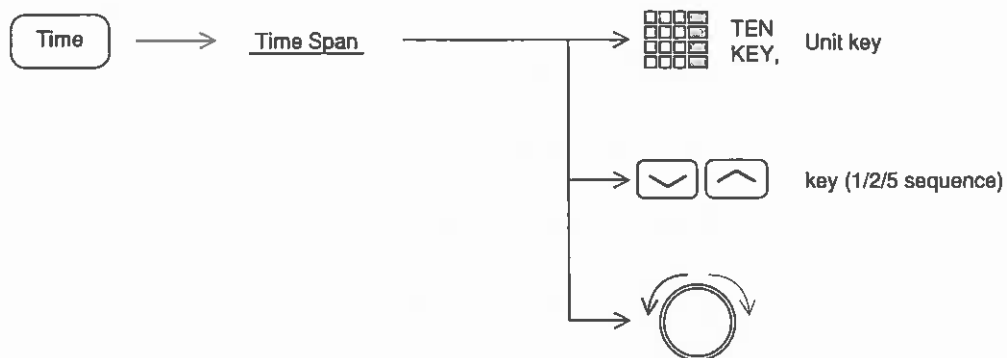

Time Domain Expanded Display

Part of the time domain time axis can be expanded and displayed.

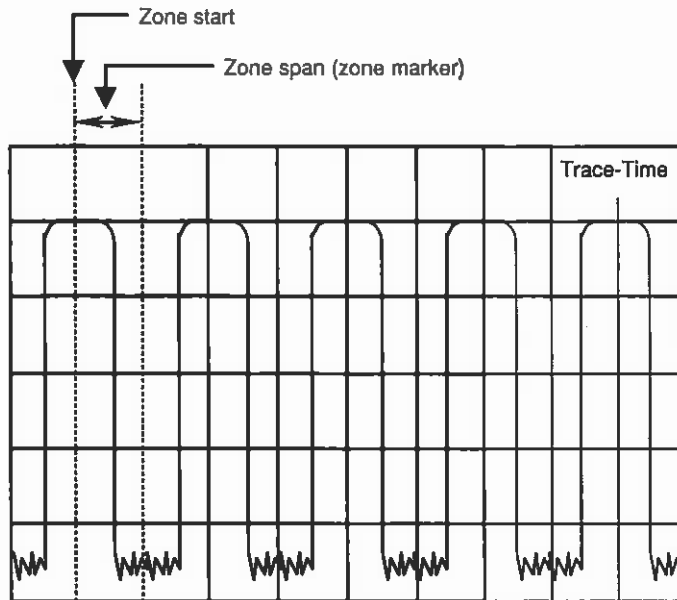
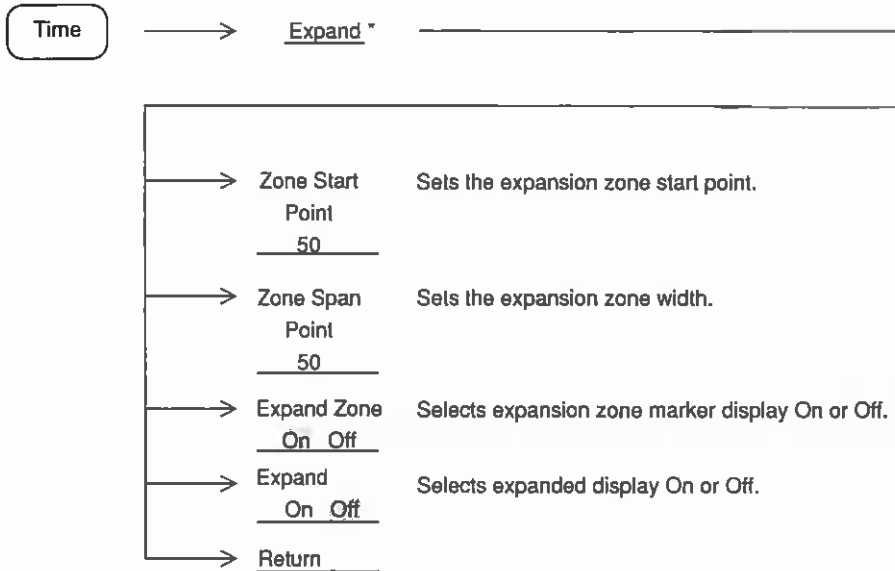

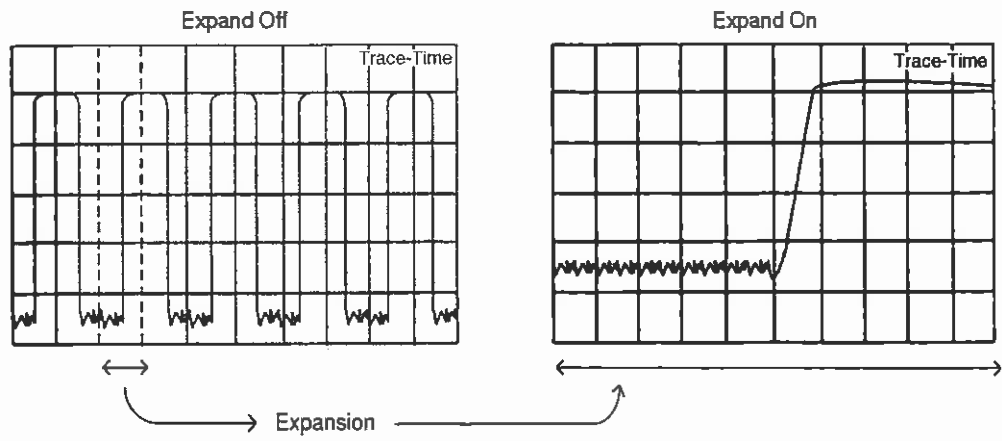

The Expand mode cannot be executed under the following conditions:

- Trigger mode Freerun

Section 6 Selecting the Sweep Method

This section describes the sweep mode, trigger sweep mode, zone sweep, and signal tracking and time gate functions.

Sweep Mode	6-3
Continuous Sweep Mode	6-3
Single Sweep Mode	6-4
Trigger Mode	6-5
Freerun	6-5
Triggered	6-6
Video Trigger	6-7
Wide IF Video Trigger	6-8
External Trigger	6-8
Line Trigger	6-10
Delay Time	6-10
Zone Sweep and Signal Tracking	6-12
Zone Sweep	6-12
Signal Tracking	6-13
Time Gate Function	6-14
Creating a Gate Control Signal	6-17
Setting Gate Function	6-18

Sweep Mode

The spectrum analyzer sweep mode is set by using the following key.

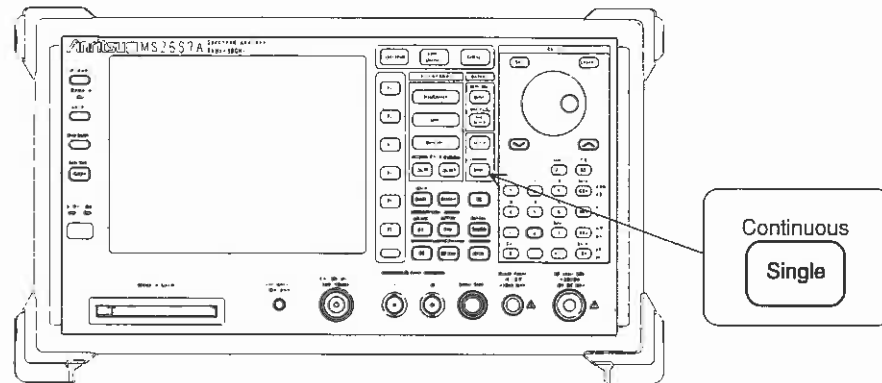

Continuous Sweep Mode

When the trigger mode is set to Freerun, sweep is performed continuously. When the trigger mode is set to Triggered, sweep is executed each time the trigger conditions are met.

To set the continuous sweep mode, perform the following key operation (The continuous sweep mode is initially set.):

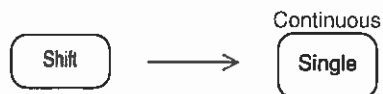

Single Sweep Mode

When the trigger mode is set to Freerun, sweep is executed once immediately after the ^{Continuous} **Single** key is pressed.

When the trigger mode is set to Triggered, sweep is executed only once when the trigger conditions are met after the ^{Continuous} **Single** key is pressed.

To set (sweep start) the single sweep mode, operate the following key.



Trigger Mode

The spectrum analyzer trigger mode can be divided into Freerun and Triggered.

In the Triggered mode, Video, Wide IF Video, External, or Line can be selected as the trigger source.

Freerun

When the sweep mode is set to continuous, sweep is repeated continuously. When the sweep mode is set to single sweep, sweep is started immediately after the ^{Continuous} **Single** key is pressed.

To set the Freerun mode, perform the following key operations (The Freerun mode is initially set.):

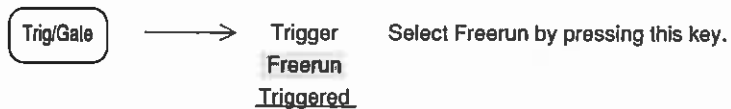

Triggered

When the conditions of the pre-selected trigger source are met, sweep is started.

To set the Triggered mode and to select the trigger source, perform the following key operations:

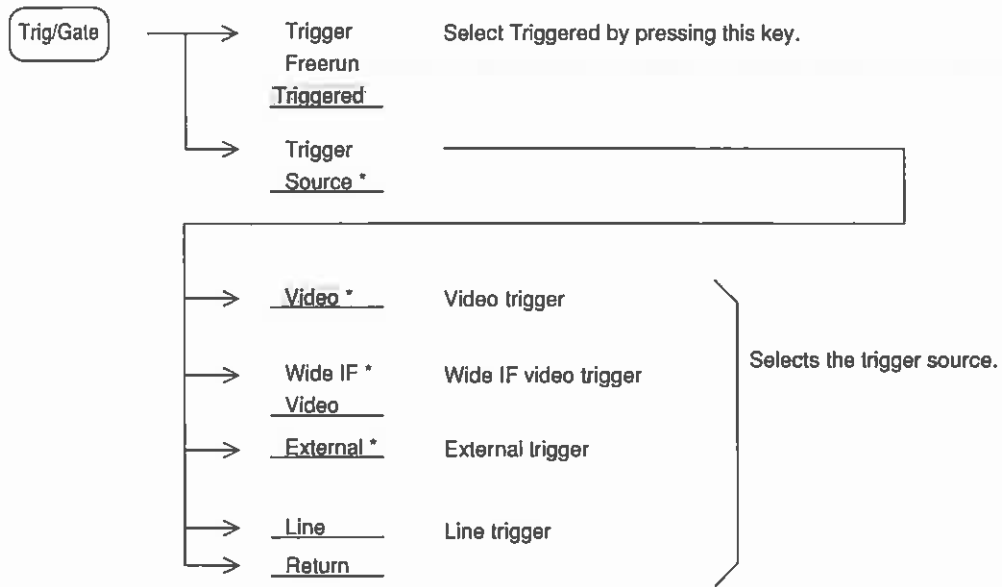

Video Trigger

Sweep is started in synchronization with the positive leading edge or negative leading edge of the detected waveform.

To select the trigger level and trigger slope, perform the following key operations:

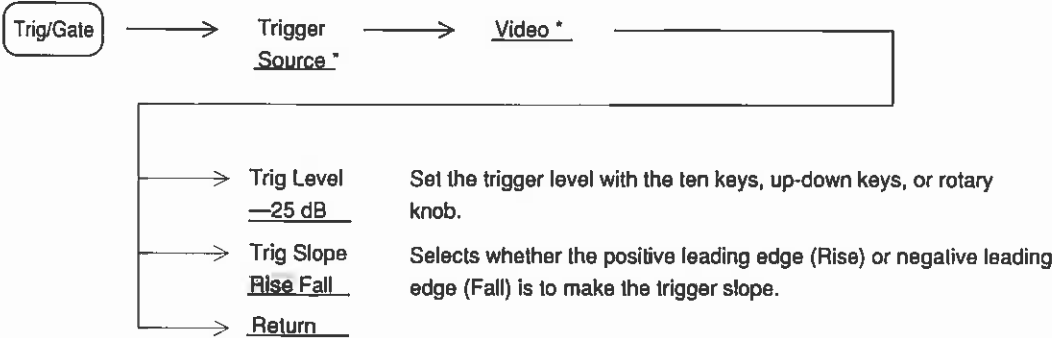

The trigger level is indicated by displaying the trigger level indicator ► at the leftmost vertical line of the screen.

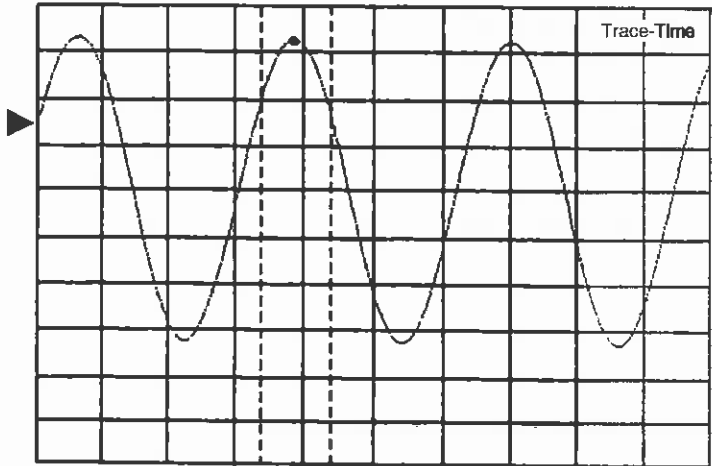

Wide IF Video Trigger

A wide bandwidth IF signal of at least 5 MHz is detected and sweep is started in synchronization with its positive leading edge or negative leading edge.

To select the trigger level and trigger slope, perform the following key operations.

Generally, there is no burst synchronizing signal and this signal is used as a burst wave gate control signal.

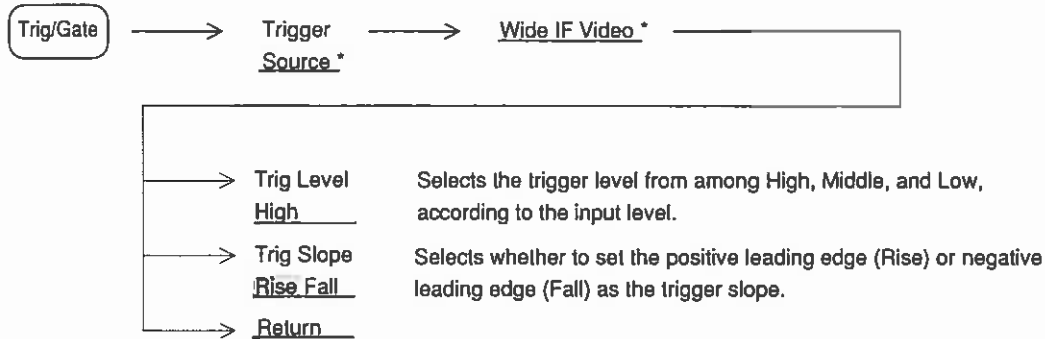

An indicator of appropriate trigger levels for Wide IF Video is listed below.

Trig Level	Mixer level*
High	-10 dBm (nominal)
Middle	-20 dBm (nominal)
Low	-30 dBm (nominal)

* This designed at 100 MHz.

Actual trig level is dependent of frequency of input.

Mixer level is “actual input of RF input” – “RF attenuator value”, if the instrument has no preamplifier option installed.

External Trigger

Sweep is started in synchronization with the positive leading edge or negative leading edge of the signal waveform input to the Ext Input connector on the rear panel. To select the trigger level and trigger slope, perform the following key operations:

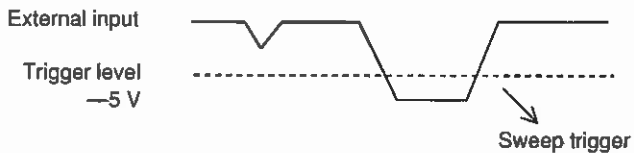
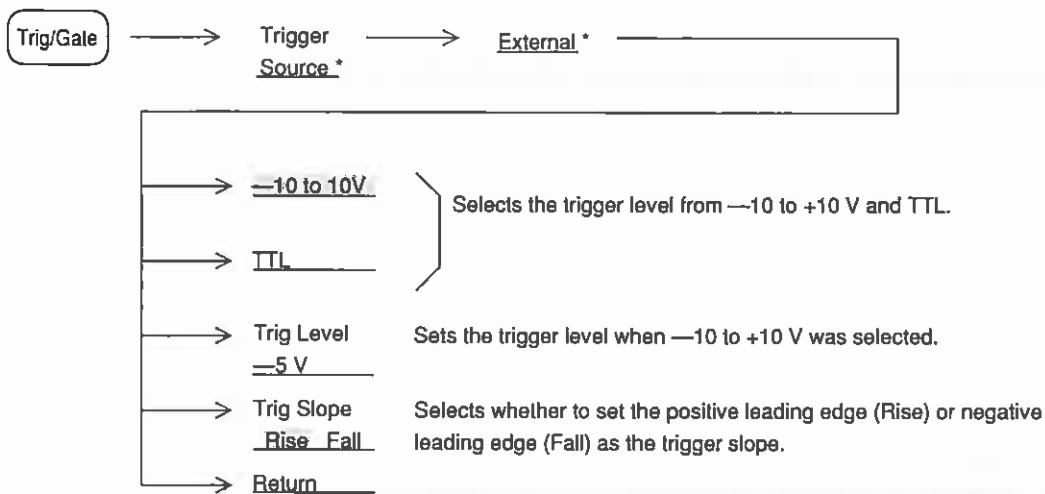

(Example) When trigger level is -5 V and trigger slope is Rise

Line Trigger

This function starts sweep in synchronization with the AC power line frequency. Line trigger is conveniently used to observe power line-related hum waveform. With the line trigger function, the trigger level and trigger slope are not selected.



Delay Time

When the trigger mode is set to Triggered in the time domain mode, the trigger point is usually positioned at the left end of the screen. This, however, means that it is not possible to see the waveform before the trigger point and the waveform beyond the right end of the screen.

With the spectrum analyzer, a waveform away from the trigger point can be displayed by changing the delay time.

To set the delay time, perform the following key operations:

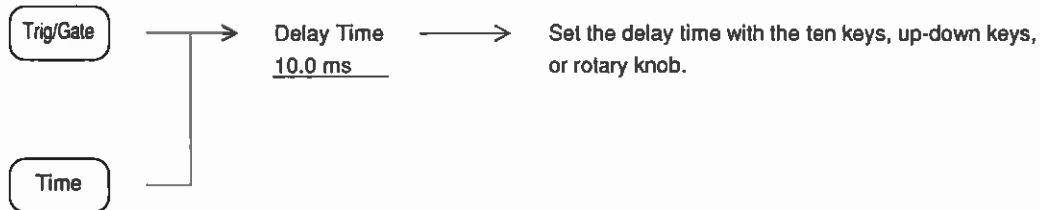

If the trigger point on the time axis on the screen was set by delay time, the trigger level indicator is displayed at the bottom of the screen.

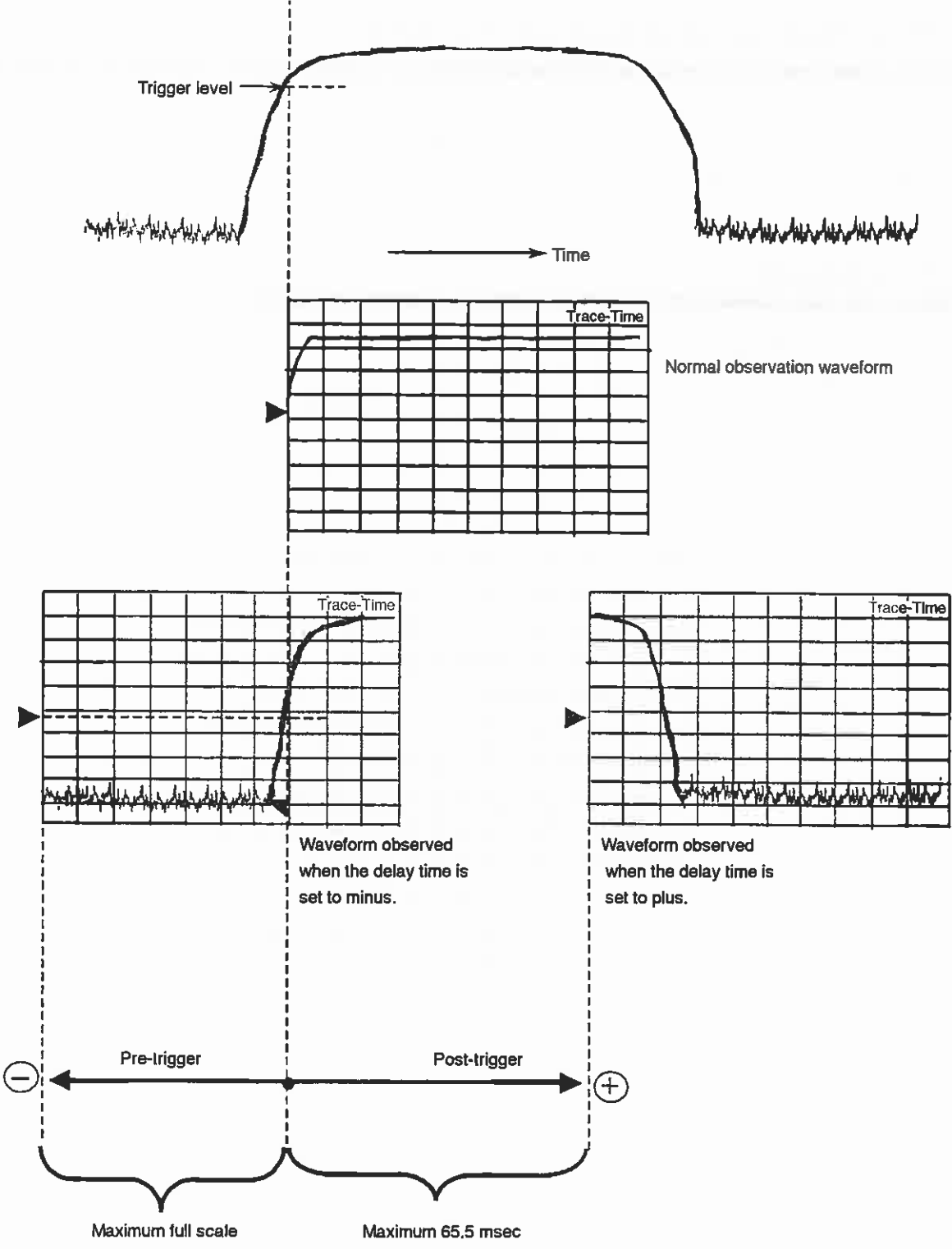

Example of Waveform With Delay Time (when used with video trigger)

Zone Sweep and Signal Tracking

The spectrum analyzer has two sweep methods - zone sweep which sweeps only within the zone marker and a signal tracking function which detects the peak level frequency at each sweep, then moves it to the center of the zone marker.

Zone Sweep



Zone sweep can be conveniently used to closely and quickly analyze part of the whole sweep range on the screen.

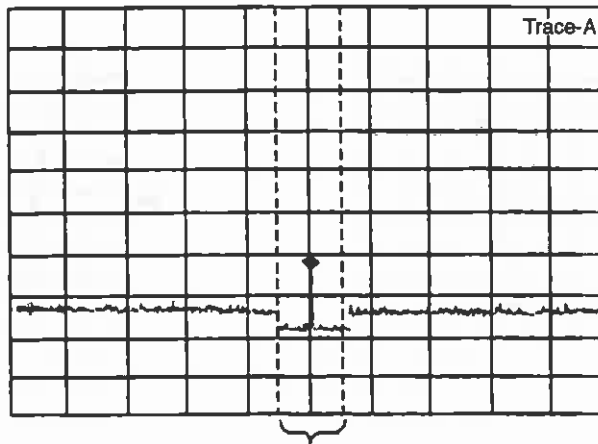

A signal masked by noise can be analyzed at high speed by setting zone sweep to On and adjusting the resolution bandwidth and video bandwidth.

Note: Zone sweep cannot be executed while the marker is Off or when the instrument is in the time domain mode.

When the multimarker function is on, Each multimarker in on state is sequentially zone-swept (multi-zone sweep).

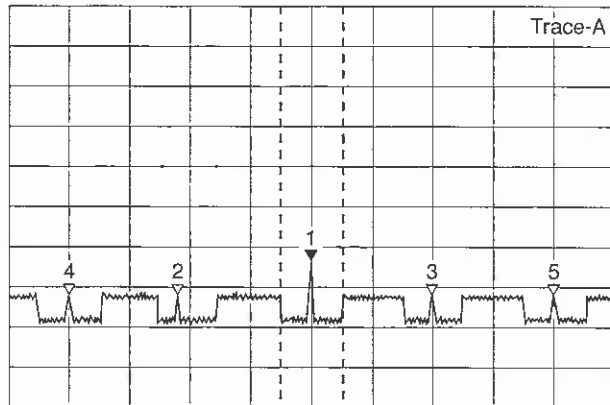

Signal Tracking



The signal tracking function moves the frequency of the signal of the peak level in the zone marker to the center of the zone marker at each sweep. This is convenient when tracking and analyzing a signal whose frequency drifts.

Note: The signal tracking function cannot be executed while the marker is Off or when the instrument is in the time domain mode.

Time Gate Function

The time gate function is a sweep mode which turns the waveform data display On and Off by the gate control signal generated in the spectrum analyzer based on an external signal or video trigger signal.

Since the timing that displays the spectrum waveform can be set by using this mode, the spectrum when the burst signal is On can be analyzed.

In order to use the time gate function, an external trigger signal synchronized with burst wave On/Off or other signal change is required to create the gate control signal.

When an external synchronizing signal is unavailable, set the trigger source to wide IF video trigger. A synchronizing signal can be obtained internally.

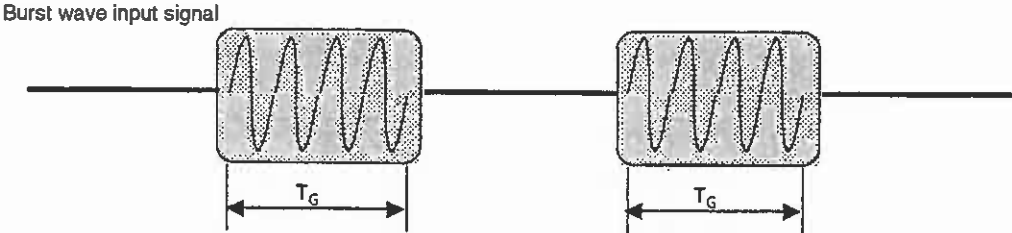

If the spectrum of the burst wave above is analyzed as it is,

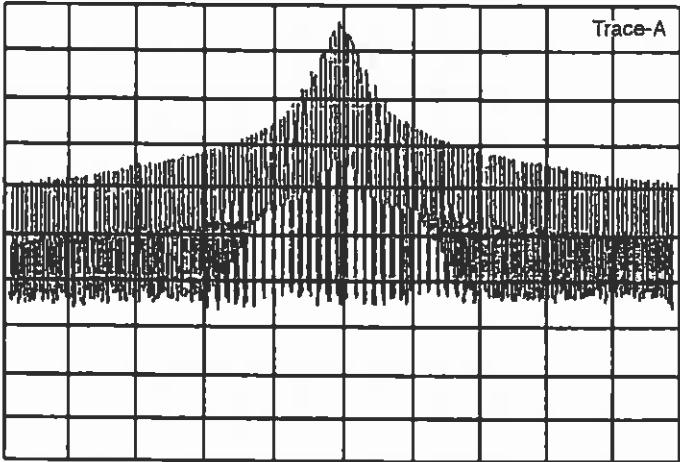

The spectrum spread by the positive leading edge or negative leading edge of the burst wave prevents the spectrum from being observed with the burst set to On.

If the spectrum can be analyzed only during the gate time T_G ,

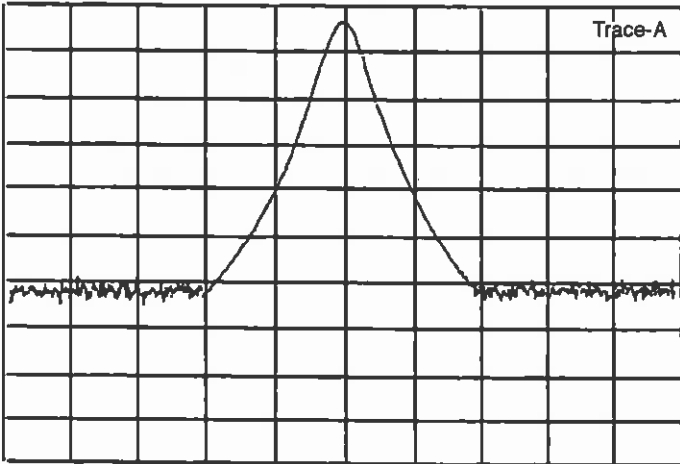

Only the spectrum when the burst is set to On is displayed.

When the time gate function is executed, sweep runs in the Freerun mode and only the waveform data validated by the gate control signal is refreshed. If the sweep period is not synchronized with the gate control signal, a perfectly shaped trace can be obtained by increasing the number of sweep repetitions.

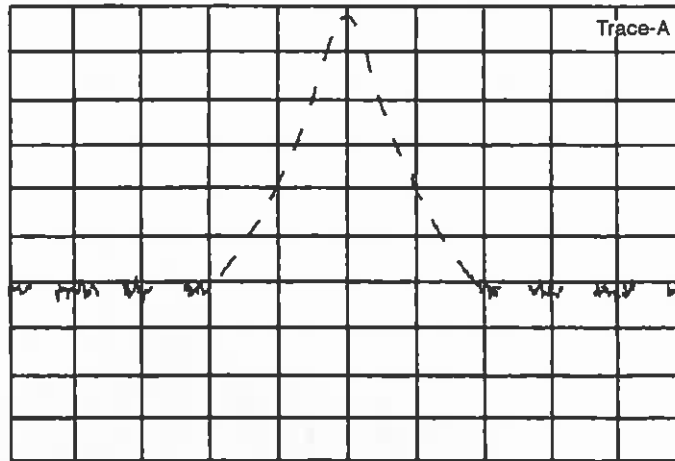

Fewer Sweep Repetitions

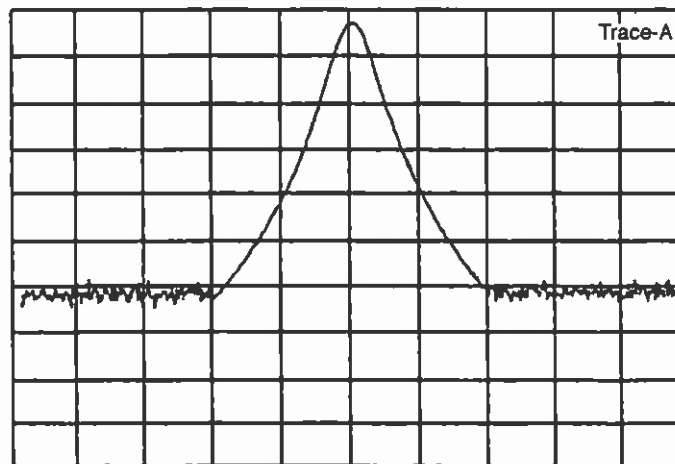

More Sweep Repetitions

Example of Frequency Spectrum Measurement on Burst Signal

Creating a Gate Control Signal

If the point where an external trigger signal (Ext Input only) or a wide IF video trigger signal is triggered is assumed to be the reference position, the gate control signal remains On over the period from the point immediately after the Gate Delay time has elapsed from the reference position to the time set by Gate Length, or to the time reset by a trigger signal.

- Gate End: When Int selected

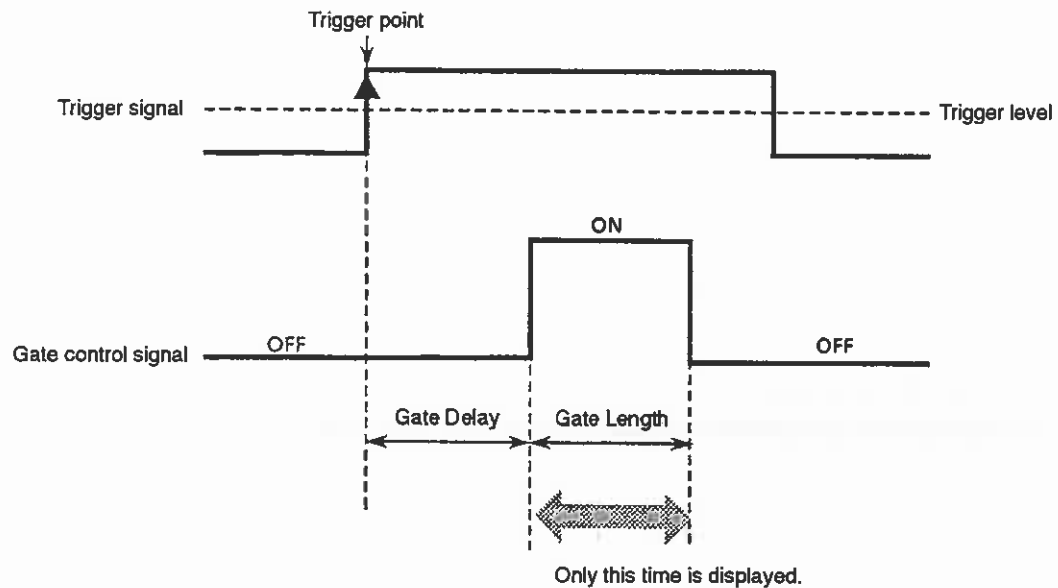

- Gate End: When Ext selected

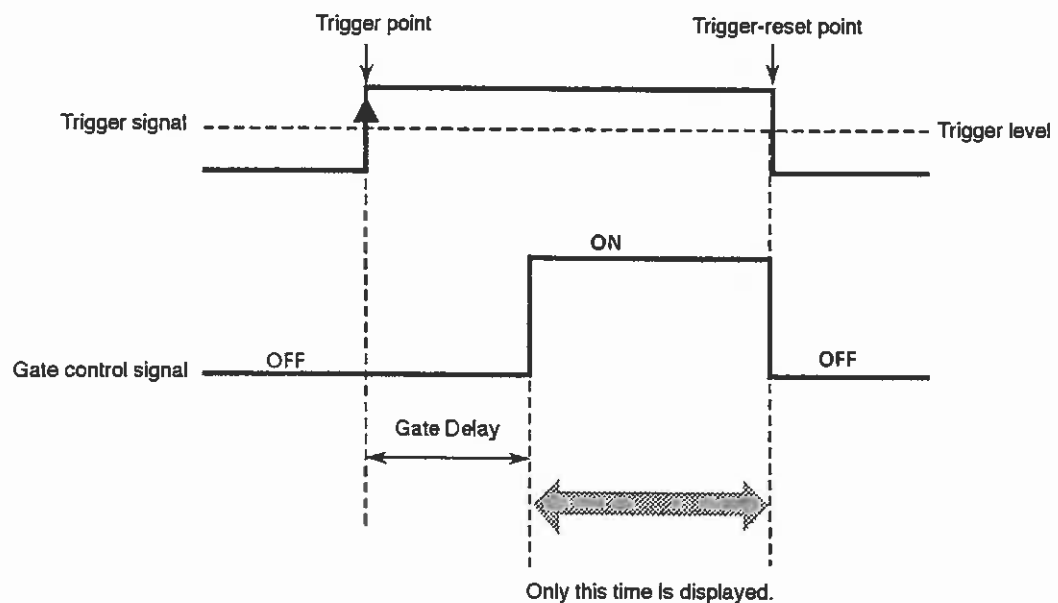

To turn the gate time analysis function On and Off and to create the gate control signal, perform the following key operations:

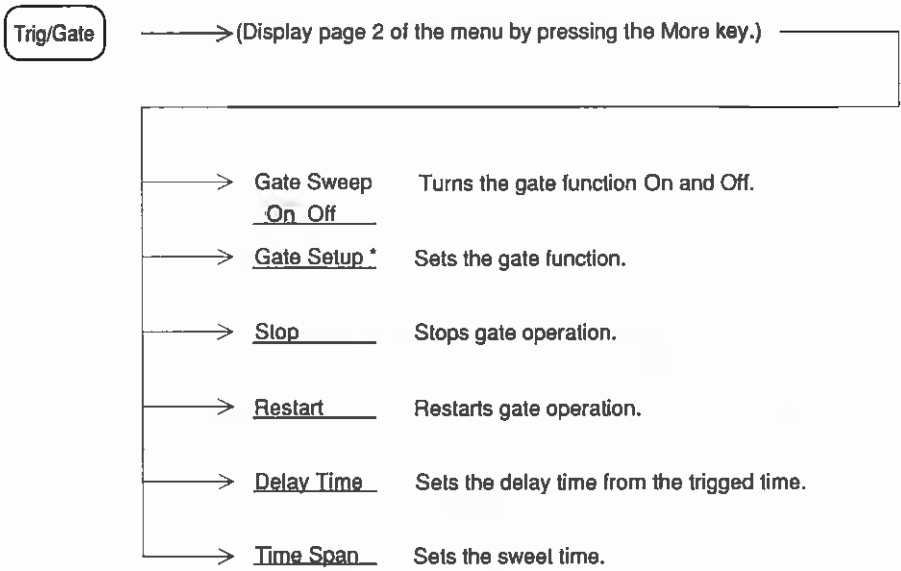

Setting Gate Function

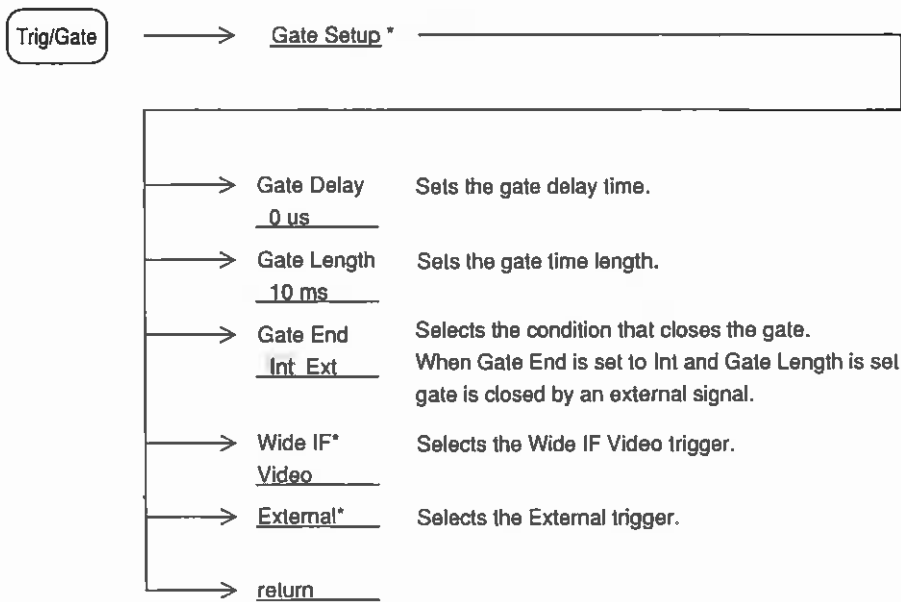

The time domain mode facilitates setting the gate control signal time. The following shows an example of how to use the Time Gate function that uses the time domain mode.

Step	Procedure
1	Input the following signals to the spectrum analyzer.

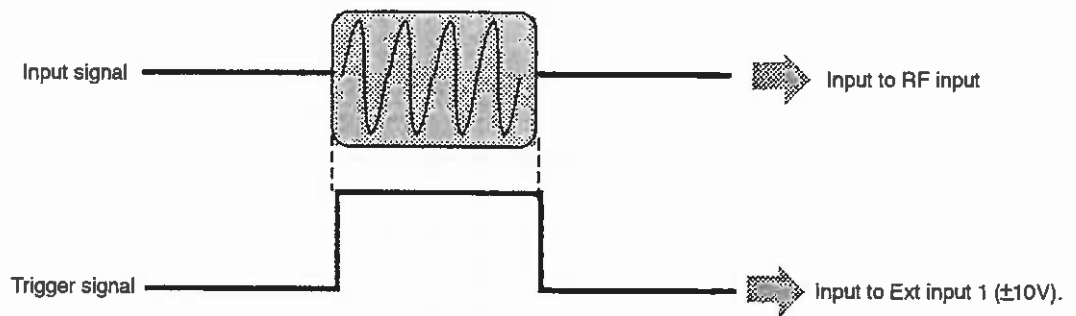

- 2 Display the waveform in the time domain mode. Synchronize the input signal by setting the trigger mode to Triggered and the trigger source to Ext Input 1 (–10 to 10 V).

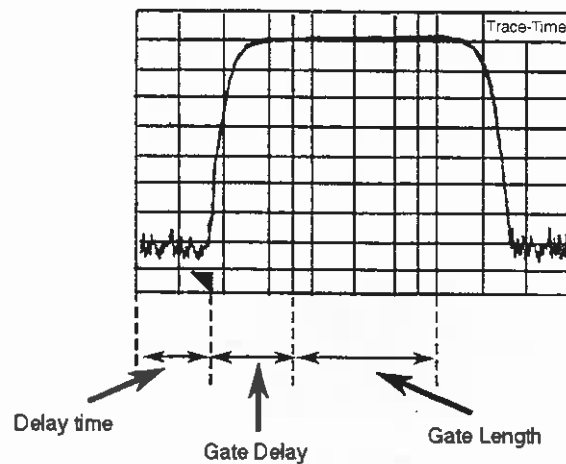

- 3 Set Gate to On. Vertical lines (gate cursor) should appear at the Gate Delay and Gate Length positions. Set Gate Delay and Gate Length to appropriate positions while observing the waveform.
- At this time, adjust the resolution bandwidth and video bandwidth in the time domain mode to equal those in the frequency domain mode, then set the gate cursor positions. The influence of spike-like noises independent of the conditions shown in Note 1 described later can be avoided.

Step	Procedure
4	Set the frequency domain mode. The trigger mode becomes Freerun and the waveform data is displayed only for the time set by Gate Length.

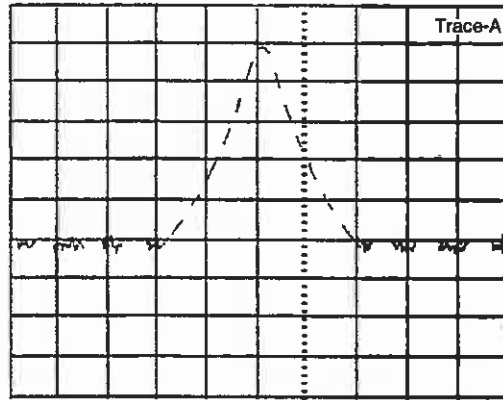

Notes: 1 The detector output is delayed compared to the positive leading edge of the input waveform when the resolution bandwidth (RBW) is narrowed in the frequency domain measurement mode. As a result, spike-like noises may appear on the trace. To prevent this from appearing, set Gate Delay and Gate Length to values that satisfy the following conditions.

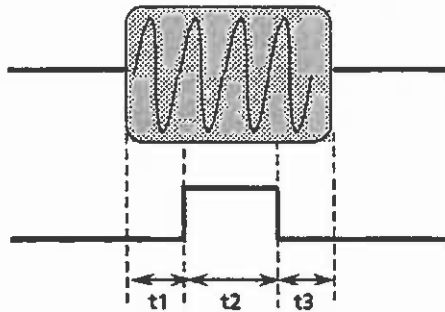

RBW	t1	t2	t3
1 kHz	≥ 3 ms	≥ 20 μ s	≥ 1 μ s
3 kHz	≥ 1 ms		
10 kHz	≥ 230 μ s		
30 kHz	≥ 200 μ s		
100 kHz	≥ 20 μ s		
300 kHz	≥ 15 μ s		
1 MHz	≥ 10 μ s		
5 MHz			

- 1 When the resolution bandwidth (RBW) is extremely narrow for the frequency span, some waveforms cannot be displayed correctly. Set each parameter so that the following conditions are satisfied:

$$\text{RBW} \geq \frac{\text{Span}}{\text{Number of data points}^*} \times 5$$

A setup to 501 points or 1001 points is possible for the number of data points.

- 3 The Time Gate function can use a video trigger as the gate control signal. In this case, the gate control signal must be generated correctly so that a trigger can be normally set with the same RBW, VBW, and trigger level conditions at all frequencies within the frequency span observed in the frequency domain. (See the figure below.)

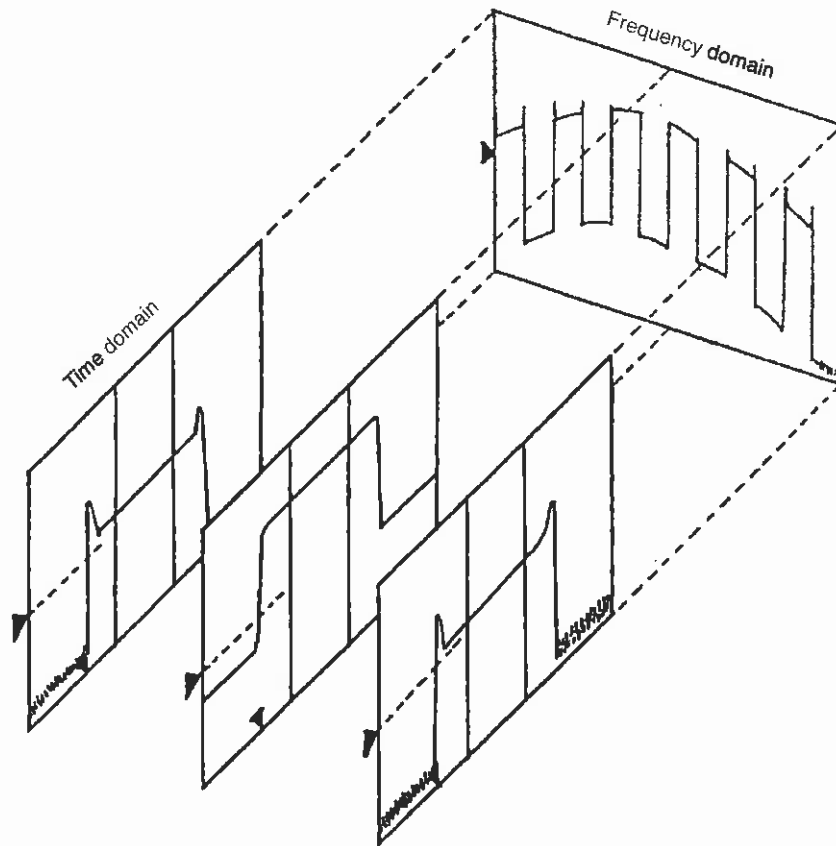

Trigger can be applied by the gate control signal created internally by setting the trigger source to Wide IF Video.

Section 7 Coupled Function

This section describes the coupled function. Generally, the spectrum analyzer automatically selects the optimum values of the coupled function so that both the correct level and correct frequency values can be measured. This is called the Auto Coupled Function. This section mainly describes manual settings that are used to set the coupled function according to the application.

From Auto to Manual Operation	7-4
Resolution Bandwidth (RBW) and Sweep Time	7-5
Video Bandwidth (VBW)	7-8
Input Attenuator (Atten)	7-10
Coupled Function Common/Independent Setting Mode	7-12
Ratio setup of Resolution Bandwidth	7-13
Noise reduction Function	7-14

The coupled function of the four functions Resolution Bandwidth (RBW), Video Bandwidth (VBW), Sweep Time, and Attenuation (Atten) is initially set to Auto so that the spectrum analyzer can automatically select the optimum setting.

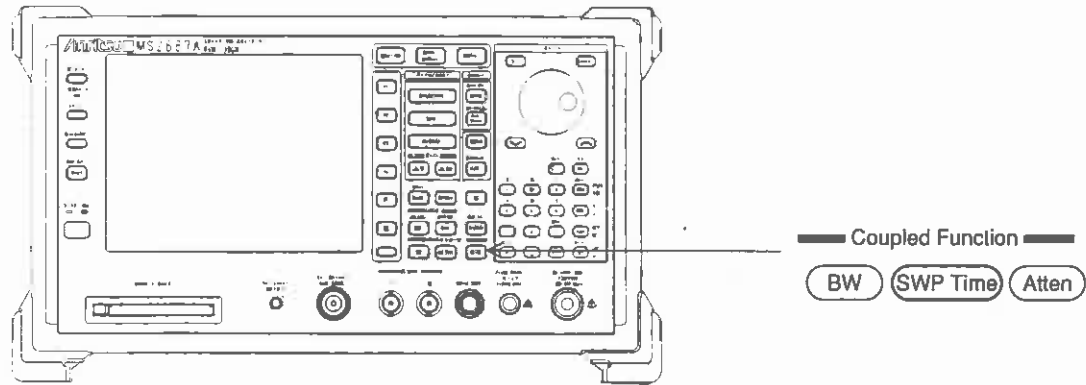

From Auto to Manual Operation

Perform manual setting as follows:

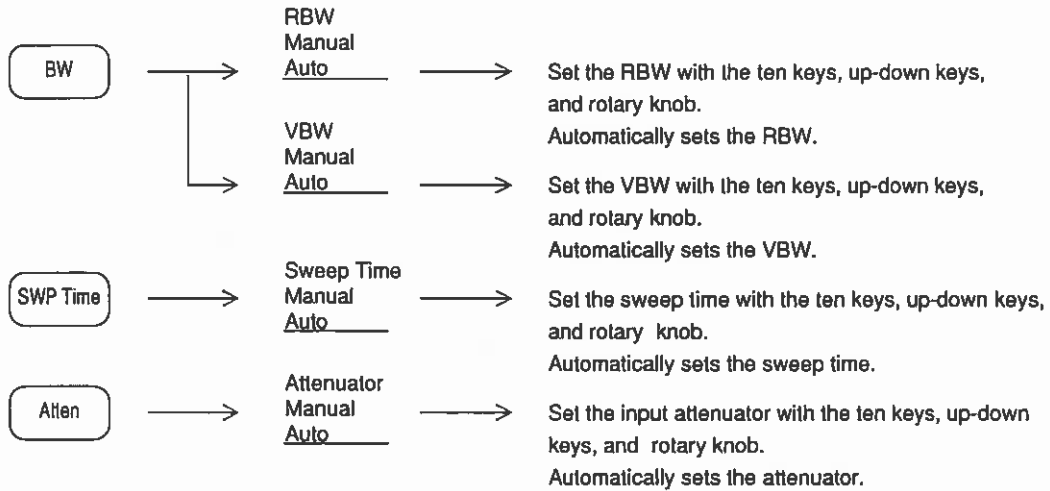

Resolution Bandwidth (RBW) and Sweep Time

To set the RBW and Sweep Time, perform the following key operations:

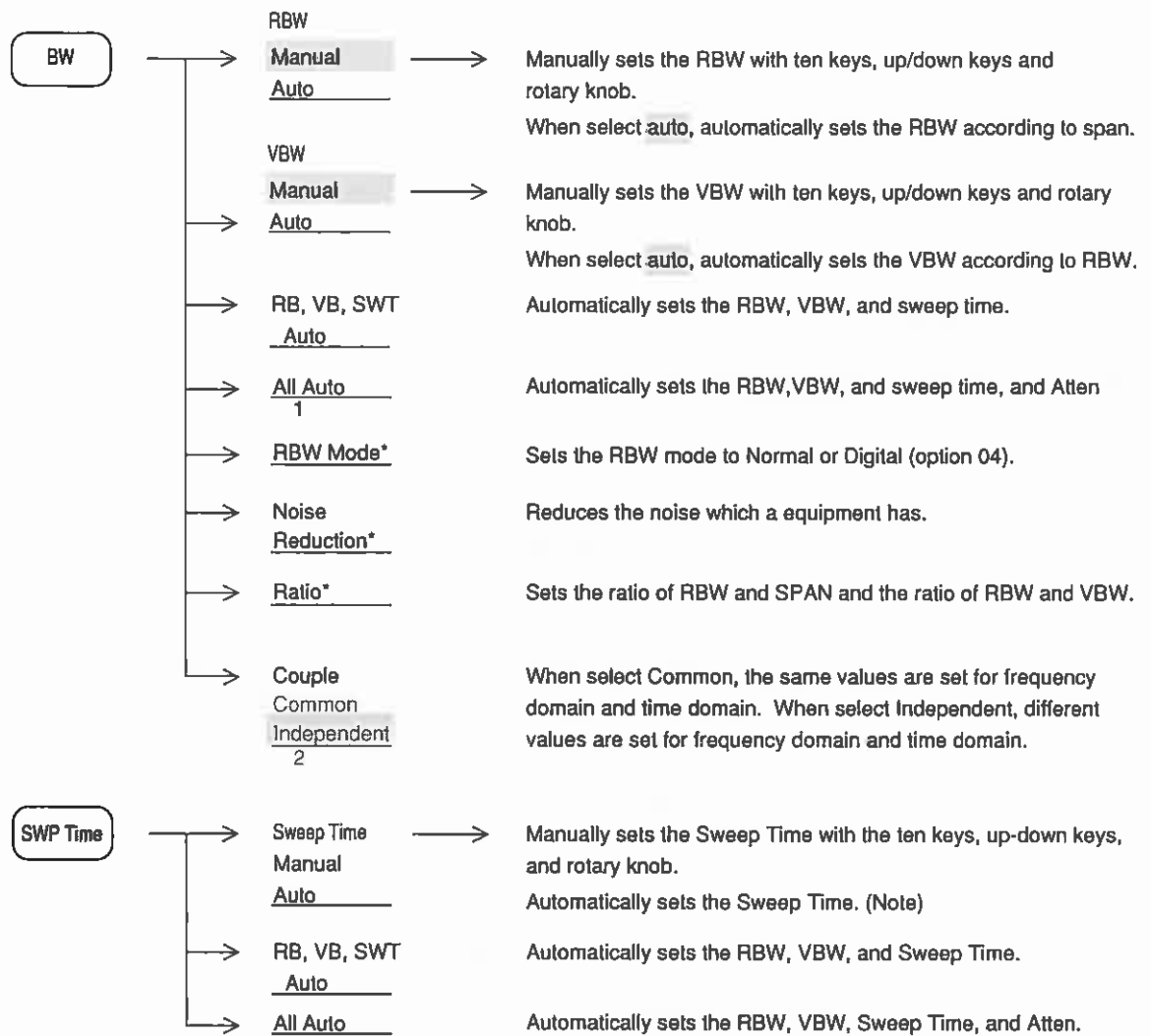

(1) Auto mode

The RBW, Sweep Time, and VBW parameters are set to Auto so that even if the frequency span is varied, the respective parameters are automatically set to the optimum values so that frequency and level measurement errors do not occur.

The following shows the Swp Time Auto setting range:

- Lower limit value
10 msec
- Upper limit value
1000 sec

(2) Manual setting

If RBW, VBW, and Sweep Time are set to the Auto mode, normal measurements can be made without considering their settings.

However, in the following cases, RBW should be set to the Manual mode.

General measurements: When observing two adjacent signals, increasing the frequency resolution by narrowing the RBW can reduce the noise level (a tenth part of the current RBW results in a 10 dB reduction).

However, if the RBW is too narrow, the spectrum waveforms will become too steep, the response characteristics become worse, and the sweep time will also become longer. Therefore, the RBW value should be determined to give a practical sweep speed.

Intermodulation distortion measurement: When measuring two signal intermodulation distortion with a comparatively wide frequency span and a reduced noise level, the RBW value should be narrowed by manual setting. However, the sweep time increases in inverse proportion to the square of the RBW.

Very small signal measurement: If FFT filter of the option which can be set up in a minimum of 1 Hz is used when measuring the very small signal of CW, a dynamic range is made large and can be observed.

The RBW can be selected from among the following by Manual setting:

Standard configuration:

300 Hz, 1 kHz, 3 kHz, 10 kHz, 30 kHz, 100 kHz, 300 kHz, 1 MHz, 3 MHz, 5 MHz, 10 MHz, 20MHz

Note: RBW = 20 MHz is available at Band 0, because pre-selector band width effects RBW at Band 1.

Option 04: 10 Hz, 30 Hz, 100 Hz, 300 Hz, 1 kHz, 3 kHz, 10 kHz, 30 kHz, 100 kHz, 300 kHz, 1 MHz
Option 04 is using the digital filter of FIR system.

Option 02: 1 Hz, 3 Hz, 10 Hz, 30 Hz, 100 Hz, 300 Hz, 1 kHz

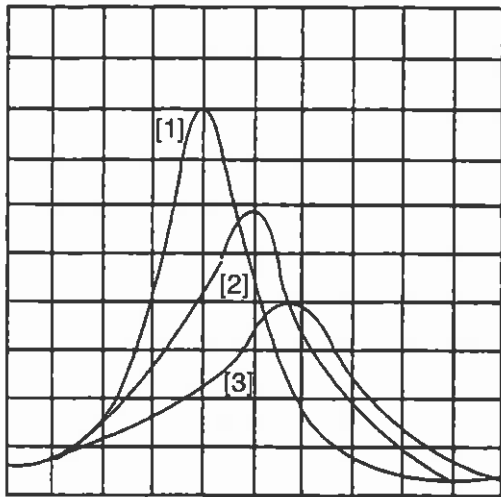

Note:

The spectrum traces on the screen are displayed as shown at the left according to the sweep time. The optimum sweep time gives a waveform like [1]. However, a sweep time that is too fast decreases the waveform amplitude on the display as shown in [2] and [3]. Therefore, the apparent bandwidth gets wider, and the frequency also shifts. When waveform [1] cannot be maintained, "UNCAL" is displayed.

[1] Optimum trace waveform
 [2],[3] UNCAL trace waveforms

(3) Setting RBW mode

RBW to be used can be chosen from analog filter, FFT filter, FIR filter when it equips with Option 02 and Option 04.

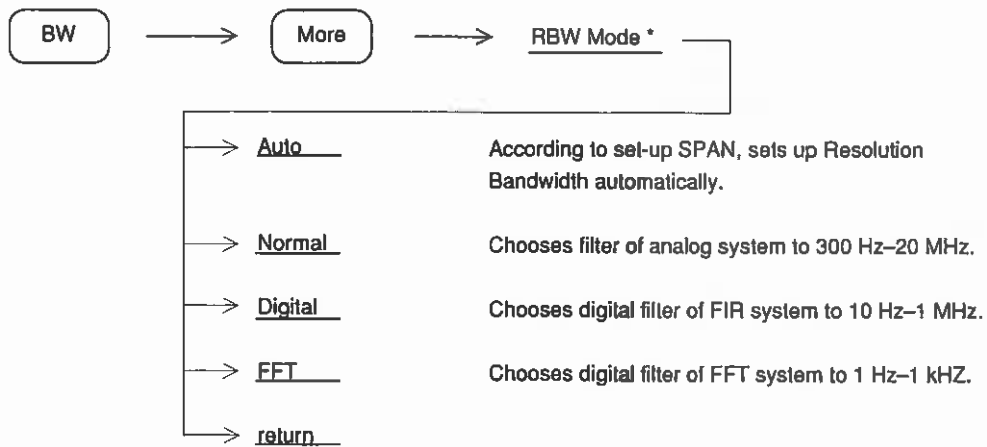

Video Bandwidth (VBW)

To set the VBW, perform the following key operations.

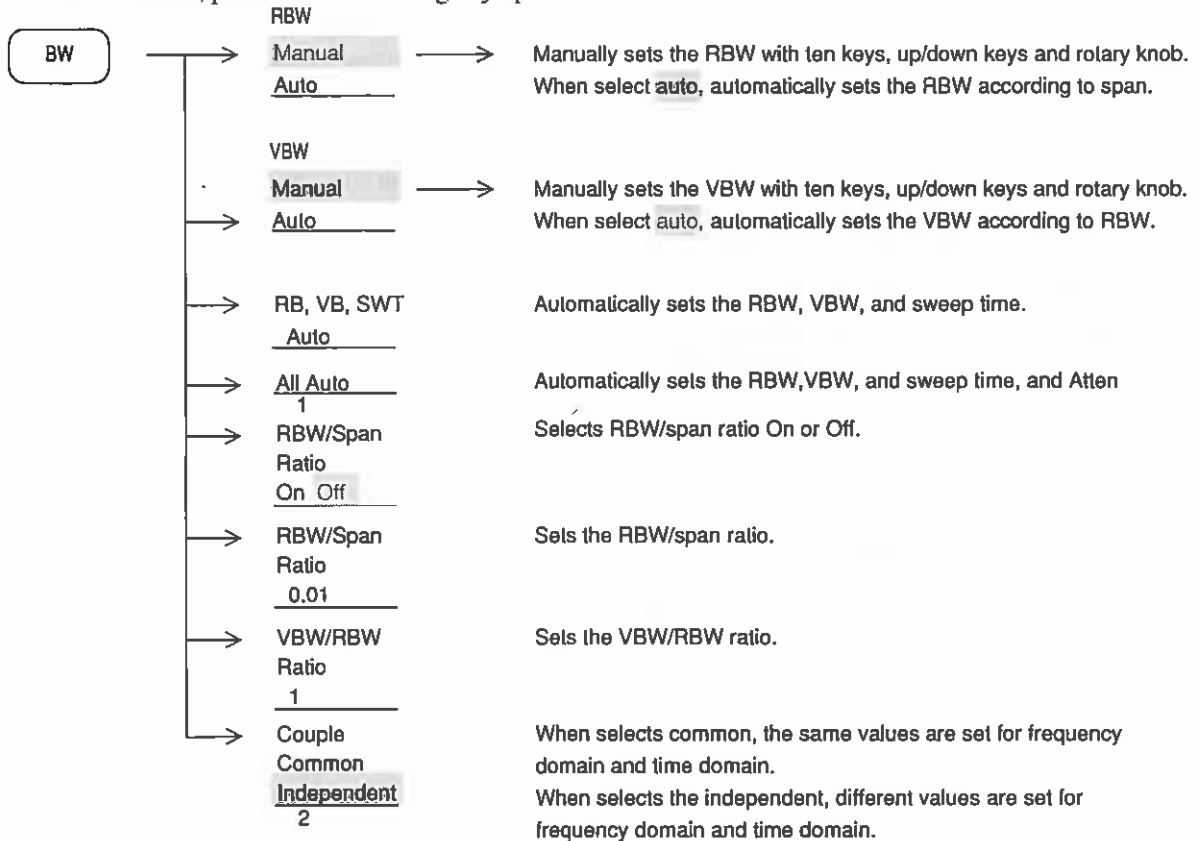

(1) Auto mode

When VBW is set to Auto, the product of the RBW set value multiplied by the VB/RB Ratio is set. Since VB/RB Ratio is initially set to 1, RBW and VBW are set to the same value.

By setting the VB/RB Ratio to a small value, since VBW is set to a narrow value according to the RBW setting, noise can be efficiently averaged.

Note: Since the VBW setting range is 1 Hz to 3 MHz, if an attempt is made to exceed this range, the VBW is set to 1 Hz or 3 MHz.

(2) Manual setting

When wanting to average the noise by making the VBW narrow without regard to the RBW set value, or when wanting to make the VBW wide to observe the waveform of signals modulated at a high frequency, use Manual setting.

The VBW value can be manually set from among the following values:

1 Hz, 3 Hz, 10 Hz, 30 Hz, 100 Hz, 300 Hz, 1 kHz, 3 kHz, 10 kHz, 30 kHz, 100 kHz, 300 kHz, 1 MHz, 3 MHz, OFF

- Note:
- When $VBW \geq RBW$ is set, noise is not averaged and the sweep speed is increased.
 - Noise can also be averaged without narrowing the VBW (without decreasing the sweep time) by performing video averaging. For further details, refer to Section 5.

(3) Averaging in the Digital RBW mode

VBW is not settable in Digital RBW mode.

Averaging using RMS detector in the Digital RBW mode is executed by setting sweep time long.

Increasing sweep time improves S/N.

Input Attenuator (Atten)

To set the input attenuator, perform the following key operations.

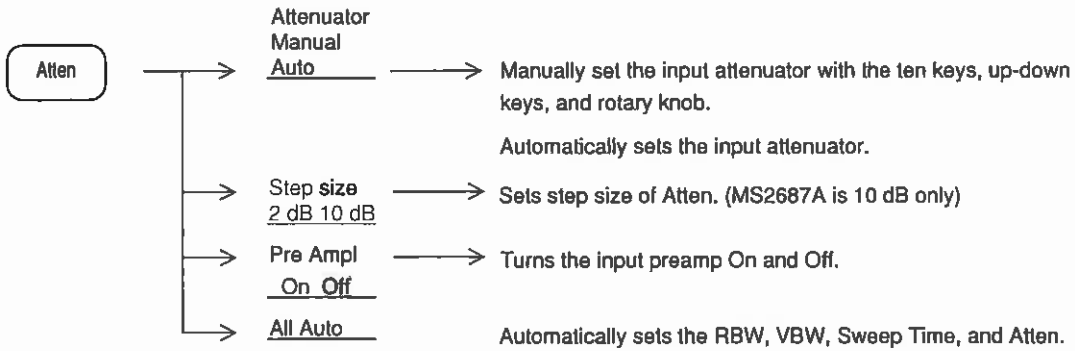

(1) Auto mode

When the reference level is set while Auto is selected, the input attenuator is automatically set to the optimum value according to the reference level.

(2) Step size

Atten step size can be selectable 2 dB or 10 dB. When measures the spurious (Harmonics and inter modulation), recommend using 2 dB step size Optimizing Atten setting value suppress spurious that is generated by spectrum analyzer, and improves dynamic range and measurement speed.

(3) Manual setting

When a signal with the same level as the reference level is input, the input attenuator value in the Auto mode is controlled so that high accuracy measurements can be made without being influenced by gain compression and the noise level can be reduced. However, when you want to measure a low level signal by raising the sensitivity when measuring nonharmonic spurious response and the spurious response of adjacent signals, measurement may be impossible because the Atten values in the Auto mode are too large. In this case, set the input attenuator manually according to the table above.

Reference Level and Input Attenuator (Manual)

Reference Level effective range (dBm)	Atten Manual (dB)
+30 to -30	60
+30 to -40	60
+30 to -50	50
+30 to -60	40
+20 to -70	30
+10 to -80	20
0 to -90	10
-10 to -100	0

A small input attenuator value can be set within the range at which internal mixer level = {(same input level as reference level) - (input attenuator set value)} is -10 dBm or less.

For second and third harmonic measurements, the influence of internal distortion must be eliminated by decreasing the mixer input level. Because the internal distortion is -80 dB when the mixer input level is -30 dBm, when wanting to measure spurious harmonics up to -80 dB, the mixer input level must be made -30 dBm or less. In this case, set the input attenuator manually because the Atten value in the Auto mode is too small.

Coupled Function Common/Independent Setting Mode

At factory shipment, the four coupled functions RBW, VBW, Sweep time (Time Span), and Atten are set to have the independent value for frequency domain and time domain.

When these coupling functions are desired to be used with the same sense of operation as zero span of a traditional spectrum analyzer, they can be set commonly by making the following system settings.

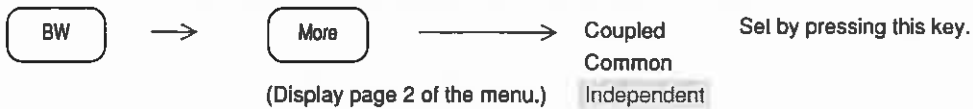

- Common Sets the same values for both frequency domain and time domain.
- Independent Sets the different values for frequency domain and time domain.

The Atten value cannot be set independently. When the coupled mode is set to Independent, “RBW” and “VBW” displayed at the top of the screen change to “RBWt” and “VBWt”, respectively.

Note: The sweep time (time span) setting range and resolution in the frequency domain and the time domain differ as shown below. In some cases, the same values cannot be obtained even if the coupled mode is sent to common.

Frequency domain

10 msec to 1000 sec

Resolution: 5 ms (10 ms to 1 s)
High-order 3 digits (1 s to 1000 s)

Time domain

1 μs to 1000 s

Resolution: 1, 2, 5 sequence (1 μs to 100 μs)
100 μs (100 μs to 4.9 ms)
5 ms (5 ms to 1 s)
High-order 3 digits (1 s to 1000 s)

Example: After switching to the time domain mode to set the time span to 100 μ sec when the sweep time is 300 msec into the frequency domain mode, the display mode returns to the frequency domain mode.



Since the lower limit value of the sweep time that can be set in the frequency domain mode is 20 msec, the sweep time is set to the 10 msec nearest to 100 μ sec. Then, when the display mode switches to the time domain mode, time span is renewed to 10 msec.

Ratio setup of Resolution Bandwidth

It is possible to set up the ratio of RBW, SPAN, and RBW and VBW.

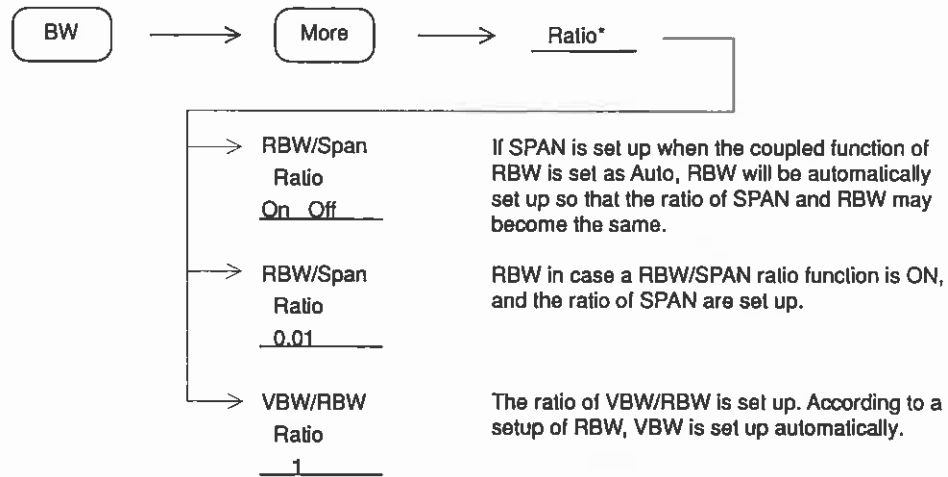

Noise reduction Function

In case a Noise reduction function performs measurement which needs a larger dynamic range, it is a function to reduce the noise which a equipment has by calculation.

This function is effective in option 04 digital resolution bandwidth at the time of use.

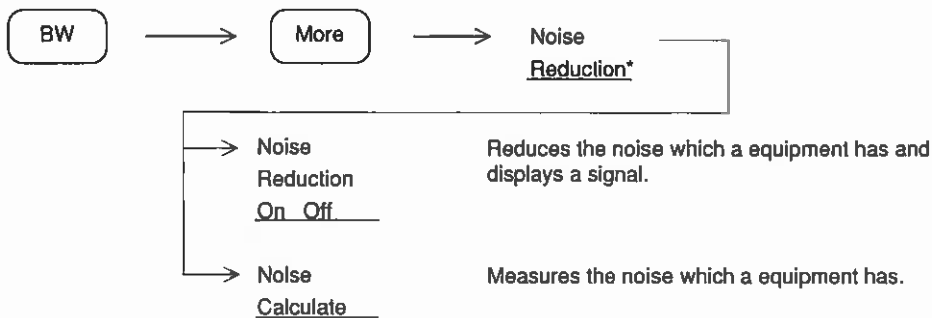

A noise reduction function performs the following processing and displays a measurement signal.

Noise electric power which a equipment has (at the time of a non-signal input): N_s , Inputted signal electric power: S ,

If result: D displayed

It is set to $D=N_s + S$ and the electric power compounded in the form where it was influenced of the noise ingredient which a equipment has is calculated.

Noise reduction function is a function which calculates this N_s beforehand.

$$D = (N_s + S) - N_s$$

The notes on this functional use

At the time of Noise Calculate execution, it carries out in the state where a signal is not inputted. When you change measurement parameters (frequency, SPAN, input attenuator ,resolution bandwidth, referenece level, etc.), please perform Noise Calculate each time. To the last, by calculation, this is a function which reduces noise, is NF which hardware has and distortion performance is not improved.

Section 8 Automatic Calibration and Level Correction Function

This section describes the internal calibration function and measuring system level correction function which minimize the spectrum analyzer measurement error.

Automatic Calibration Function	CAL	8-3
Automatic Calibration		8-4
Details of Each Calibration Item		8-5
Preselector tuning		8-6
Measurement System Level Correction		8-7

Automatic Calibration Function CAL

The spectrum analyzer incorporates a 625 kHz, 50 MHz calibration oscillator and a calibration attenuator, which perform automatic calibration so that the spectrum analyzer can minimize measurement errors and make high accuracy measurements.

WARNING

If calibration is executed with an external signal applied to the RF input, the correct calibration value cannot be obtained. Perform calibration without applying a signal to the RF input connector.

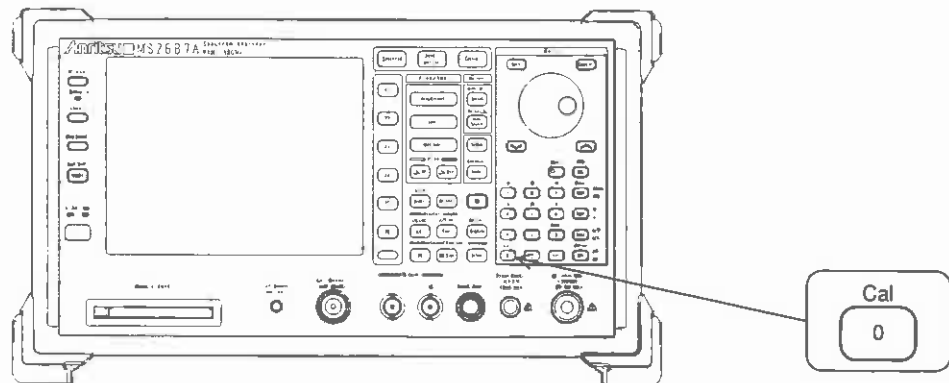

Automatic Calibration

Execute spectrum analyzer automatic calibration by performing the following key operations:

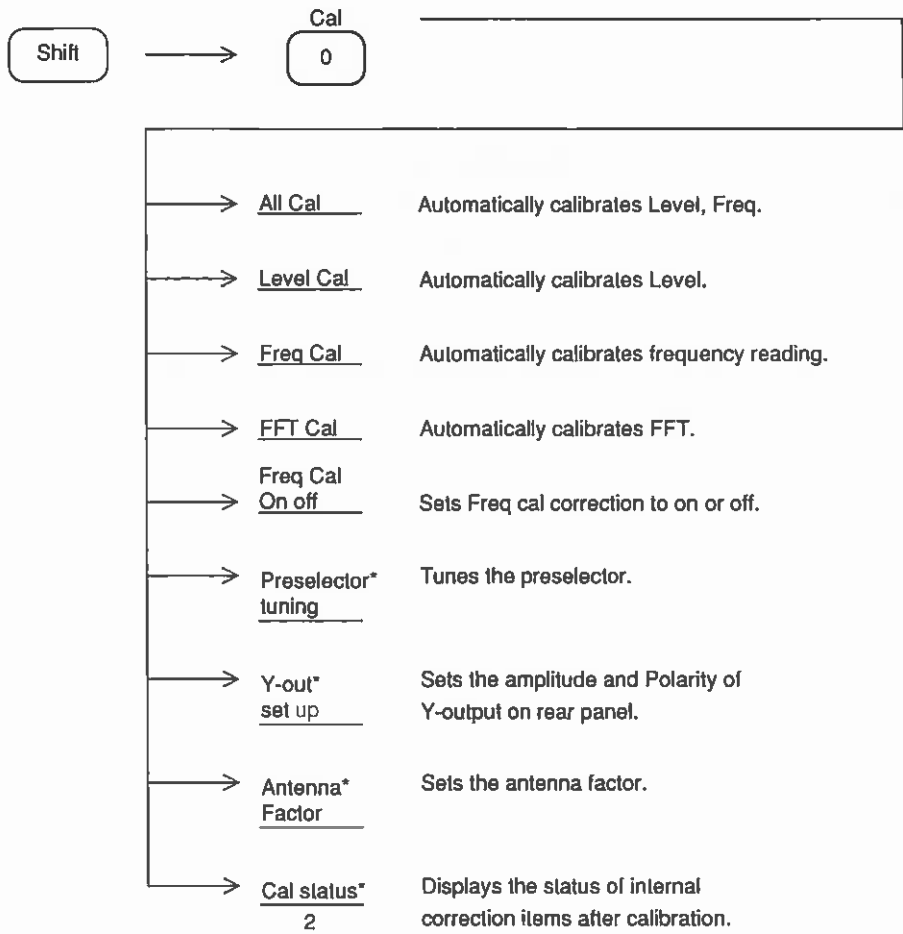

Details of Each Calibration Item

The following describes the items that are calibrated by the automatic calibration function and the items that are calibrated at the factory.

ALL CAL	LEVEL CAL	Reference level error calibration	Calibrates the absolute-value levels on the LOG/LIN scale.
		LOG-scale linearity calibration	Calibrates the LOG-scale linearity.
		IF Gain switching error correction	Calibrates the error caused by the IF gain from among the level errors when the reference level is switched.
		RBW switching error calibration	Calibrates the error when the resolution bandwidth (RBW) is switched.
		Detection-mode switching error calibration	Calibrates the level error when the detection mode (Pos Peak, Sample, Neg Peak) is switched.
		Input-attenuator/pre-amplifier switching error calibration	Calibrates the level error when the input-attenuator/pre-amplifier is switched.
	FREQ CAL	RBW center frequency calibration	Calibrates the center frequency error when the resolution bandwidth (RBW) is switched.
		RBW bandwidth measurement	Measures the RBW bandwidth used for noise measurement bandwidth conversion.
Factory Calibration	Frequency response calibration	Calibrates the amplitude frequency response over the entire band.	

When ALL CAL is executed, the calibration data is retained by the built-in battery back-up even when the spectrum analyzer power is turned off. Therefore, it is not always necessary to execute automatic calibration each time the power is turned on. However, when a particularly high accuracy measurement is required, when the specifications are not met, or when the set-up circumstances have changed greatly (such as ambient temperature), execute automatic calibration again.

- Notes:**
- Since the built-in calibration oscillator is automatically connected internally when automatic calibration is executed, external connection is unnecessary.
 - Unless the frequency span is taken into account, the measurement frequency error depends on the local oscillator frequency error and the IF center frequency error. The local oscillator is a synthesizer system and its frequency error depends on the frequency accuracy of the reference crystal oscillator or external reference signal input. Frequency-related automatic calibration calibrates the IF center frequency error.

Preselector tuning

Since this equipment is a superheterodyne type spectrum analyzer, it generates unrequired wave responses such as image responses and multiple responses.

This equipment uses a preselector to remove these unrequired wave responses and to display only true signals on the screen. The preselector is a variable synchronous type bandpass filter that follows the receiving frequency of an analyzer. Since the MS2681A/MS2683A/MS2687A/MS2687B uses the preselector in the band, the peaking is described below:

In normal use, since the initial value of the peaking bias is set for each frequency, peaking is required only when the bias value is shifted purposely.

If it is shifted, the receiving level is decreased as shown in the diagram at the bottom left. Accordingly, perform peaking so that the maximum response can be obtained as shown in that figure.

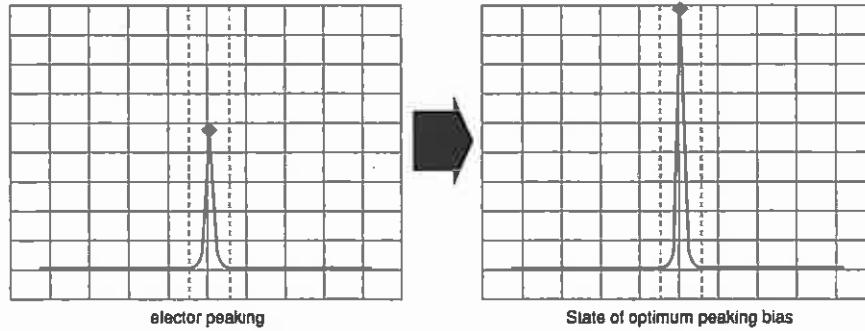

Perform peaking using the following method:

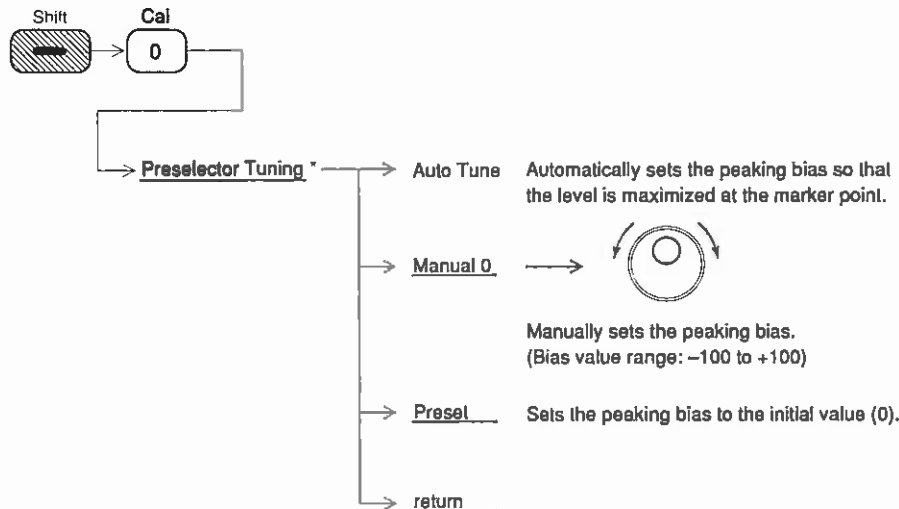

Note:

Preselector Auto Tuning cannot be done when:

- The frequency span exceeds 500 MHz.
- Trace BG is the main trace in the trace A/trace BG indication.

Measurement System Level Correction

When making measurements with a spectrum analyzer, it may be necessary to correct the error and gain of the measurement system. The following are examples of this:

- [1] Frequency characteristics and loss of measurement cables
- [2] Frequency characteristics and loss of pre-amplifier, etc. connected to RF input connector
- [3] When wanting to measure the field strength with an antenna or near-field probe connected (antenna factor correction)

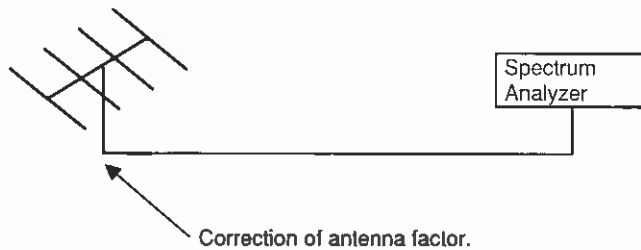
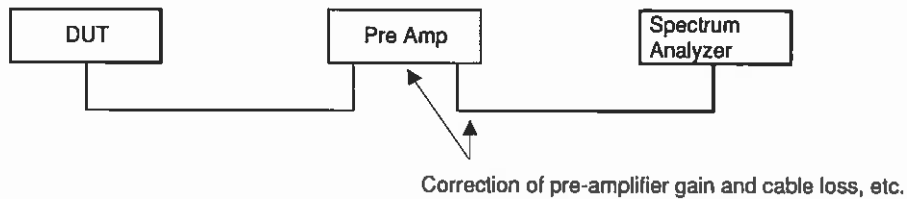
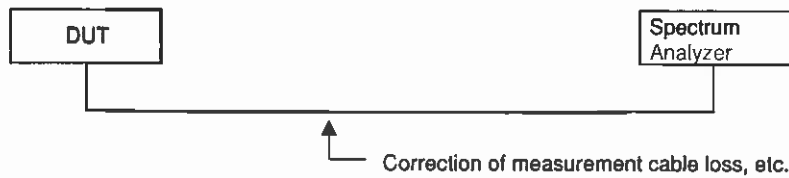

The correction factors for these measurement systems can be stored in the internal memory to add the factor to the measured value and display the spectrum.

Up to five correction factors (maximum 150 points each) can be stored in the internal memory by storage from an external computer via an external interface. For a more detailed explanation of these methods, refer to the Remote Control part of the separate operation manual.

The following shows the procedure for adding the correction factor to the measured value by using the correction data saved in advance.

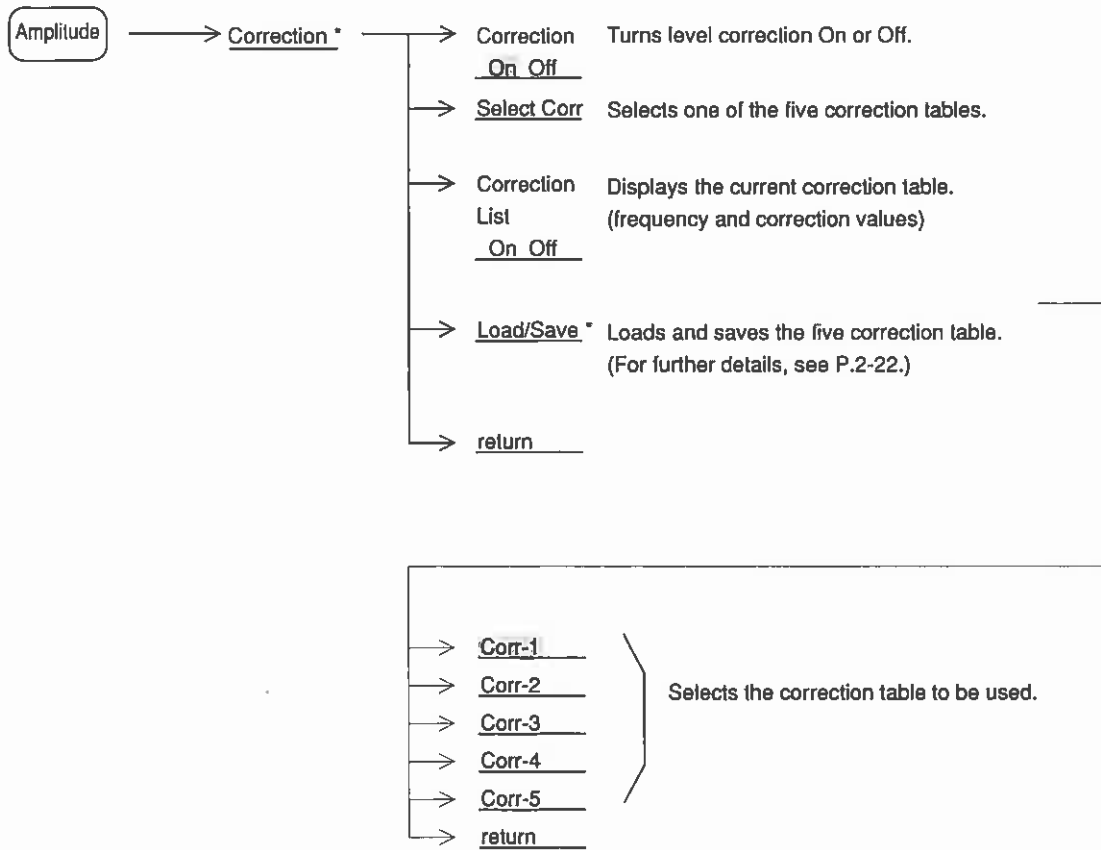

Press one of the Corr-1 to Corr-5 keys. The spectrum data is corrected and displayed by the corresponding correction value.

If the frequency range over which the correction values are entered is from F_a to F_b , displayed frequency ranges lower than F_a or higher than F_b have correction values applied as shown in the figure below. The correction value for frequencies lower than F_a is the same as that (L_a) for F_a and the correction value for frequencies higher than F_b is the same as that (L_b) for F_b .

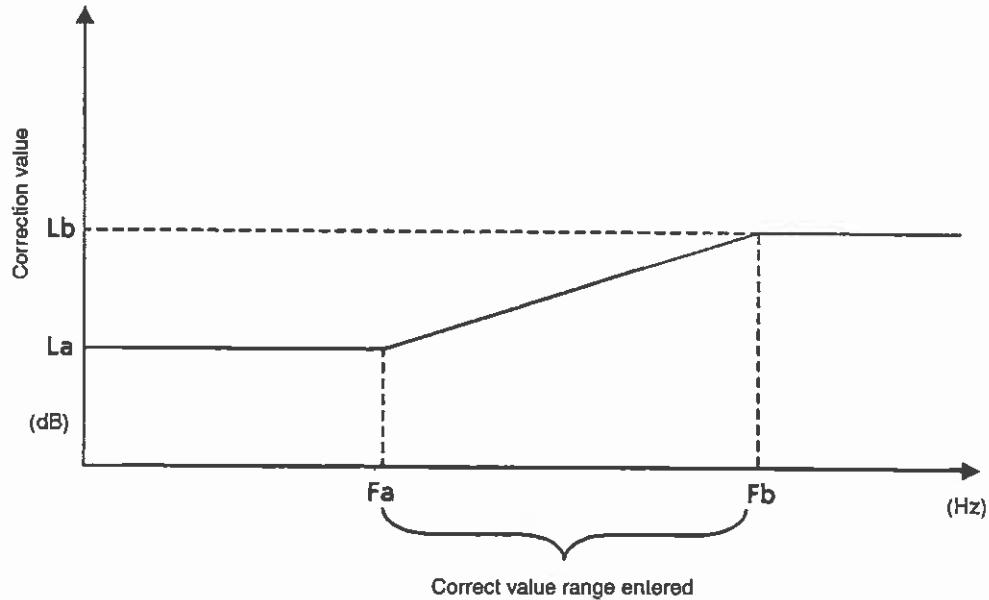

Notes:

- [1] No correction factor is entered at the factory. The correction values are all 0 dB.
- [2] The correction value is backed-up by a battery. Therefore, once the value has been entered, it is not lost even after the power is turned off.
- [3] The Corr-1 to Corr-5 soft keys allow each menu label to have up to 20 characters. The labels can be entered from the remote control command only. For further details, refer to the Remote Control part of the separate Vol.3 operation manual.

Section 9 System Setting

This section describes the spectrum analyzer system setting method.

Screen Display Type System Setting	9-4
Date Display type Setting	9-4
Modifying Display Color (Change Color)	9-5
User Definition of Display Color	9-6
Adjusting LCD Brightness	9-7
Setting VGA Out	9-8
Setting Conditions at Power-on	9-8
Setting Date/Time	9-9
Erasing Warm up Message	9-10
"X-out, Z-out" output specification in a zero span sweep	9-10

The following system parameters of the spectrum analyzer can be set depending on the usage objective.

- Measurement parameters and date display type setting Display
- Screen display color (color pattern) setting Change Color
- Adjusting LCD brightness for comfortable viewing depending on
vertical angle of observation LCD Brightness
- Setting Date/Time Set Date/Set Time
- Erasing warm up message Erase Warm up Message
- Power on state setting Power On State

These system settings are independent from, and are not affected by, the preset function.

However, they are included in the Save parameters described in Section 10, so the system settings may have changed when recalled.

Screen Display Type System Setting

This function selects the title display type and date display type that are displayed on the screen.

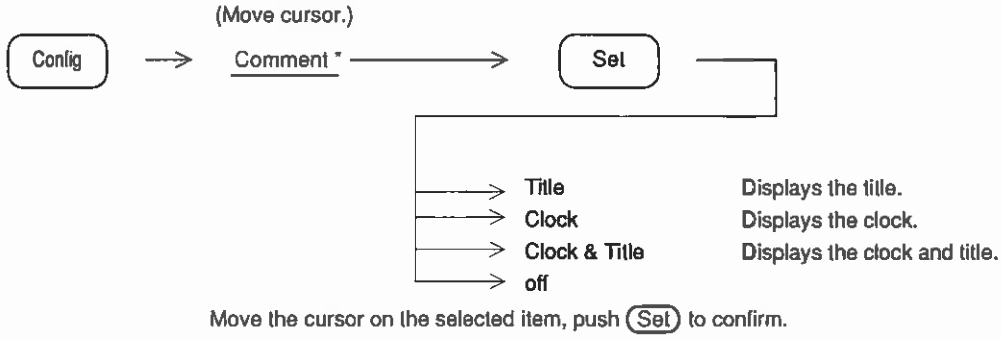

Date Display type Setting

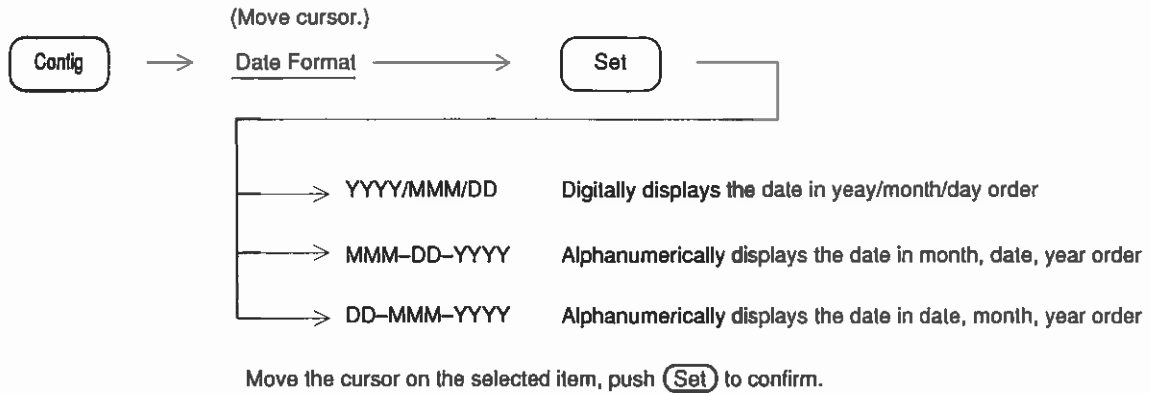

Modifying Display Color (Change Color)

This function changes the color of the trace waveform, scale, measurement parameters, menu, and other items displayed on the screen. The color pattern can be selected from among four color patterns, or defined by the user.

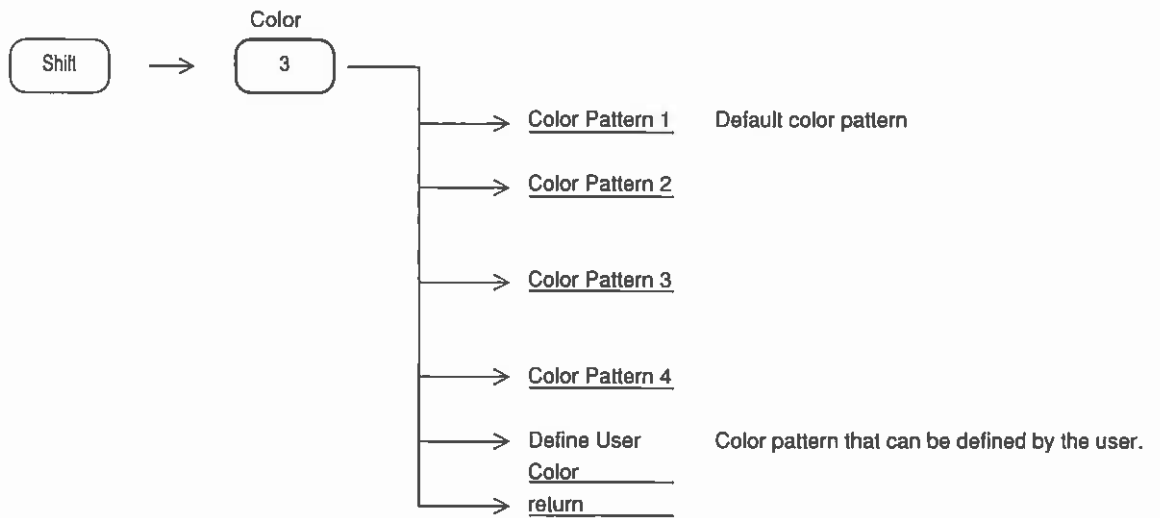

User Definition of Display Color

The MS2681A/MS2683A/MS2687A/MS2687B spectrum analyzer has a color pattern function that allows the user to define the color of the trace waveform, scale, measurement parameters, menu, and other items displayed on the screen.

Adjusting LCD Brightness

LCD Brightness can be adjusted by the following key operations:

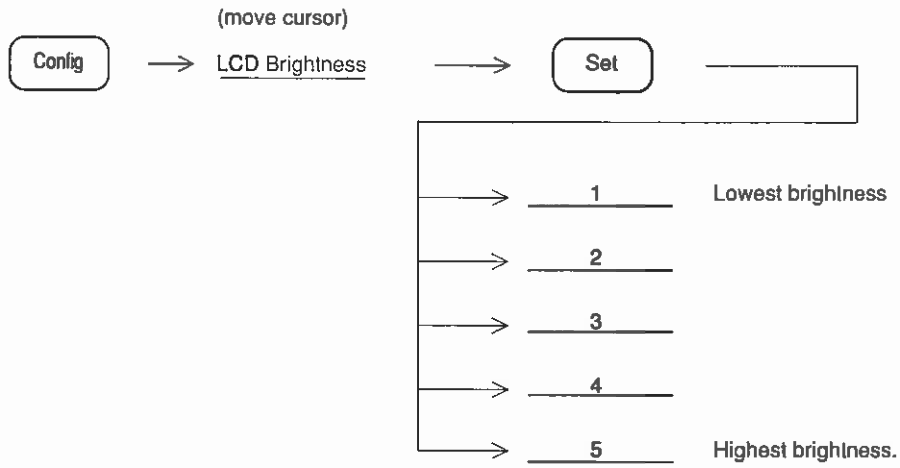

Setting VGA Out

Switching of the Video signal from the Composite Out terminal at the rear panel is carried out by the following key operations:

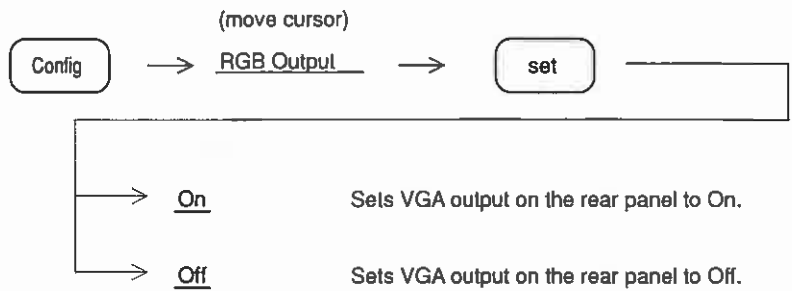

Move the cursor on the selected item, push **Set** to confirm.

Setting Conditions at Power-on

Set the state of the screen display when the power is turned on by performing the following key operations:

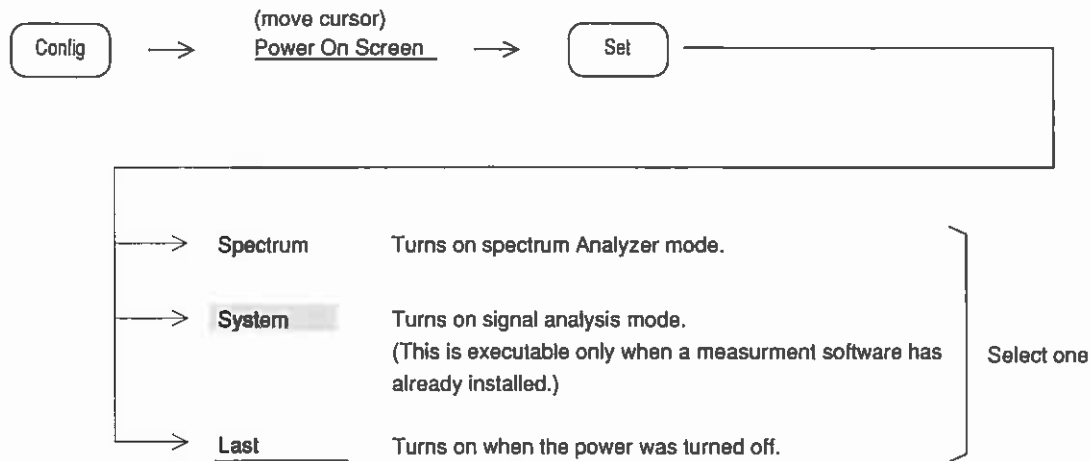

Setting Date/Time

Set the date and time by performing the following key operations.

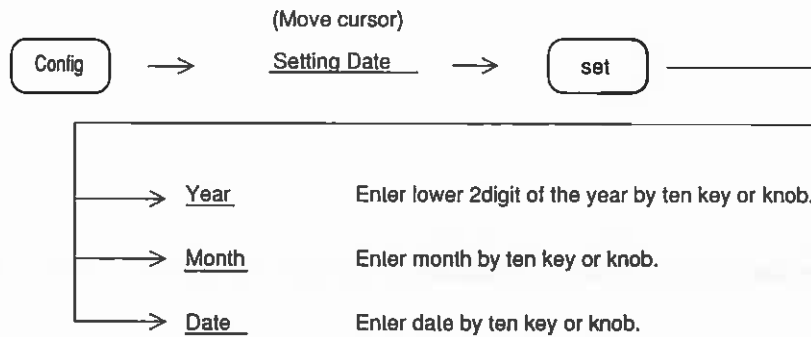

Note: For an example, when inputting 1st January 2000,

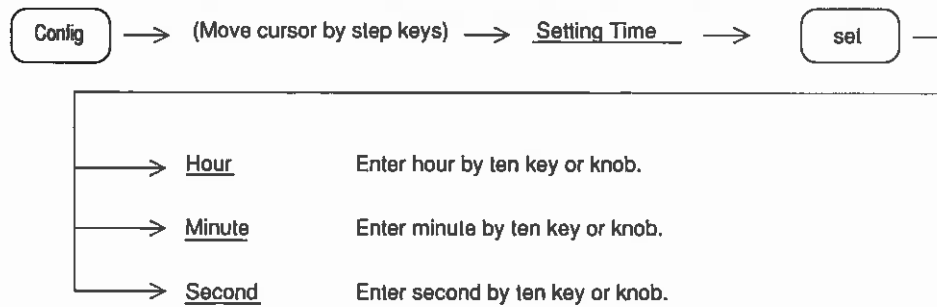
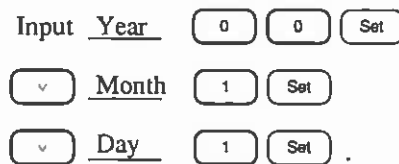

Note: For an example, when inputting 14:35;10,

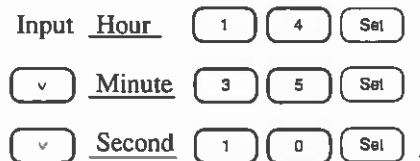

Erasing Warm up Message

"Warm up" message is indicated on the top right of the display for about 3 minutes after turning on the power. This message can be erased.



"X-out, Z-out" output specification in a zero span sweep

Sweep signal output, image signals of spectrum analyzer can be output and observed by an oscilloscope or the like.

When indicated waveforms are the traces A and B (frequency axes), each signal is output by the following timing.

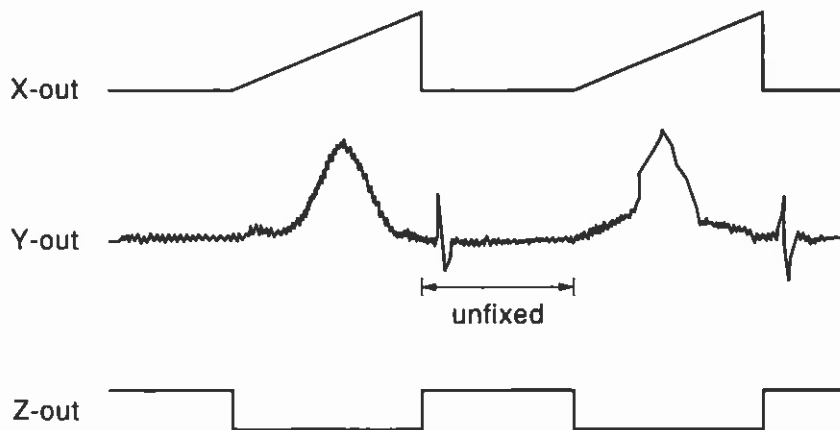

Zero Span Sweep: When trace "Time" (time axis), normally Y-out only is output, and X-out and Z-out are not output.

Section 10 Save/Recall Function

This section describes saving and recalling of the waveform and parameter data to and from internal register and memory card, respectively.

It also describes memory card file management.

Internal Register	10-4
Memory Card	10-4
Saving Parameter and Waveform Data	10-5
Recalling Parameter and Waveform Data	10-7
Selecting Recall Item	10-9
File Deletion and Write Protect	10-10

The spectrum analyzer can save the setting conditions (Parameter) and waveform data (Trace) to internal register and memory card. These data can be recalled and used later.

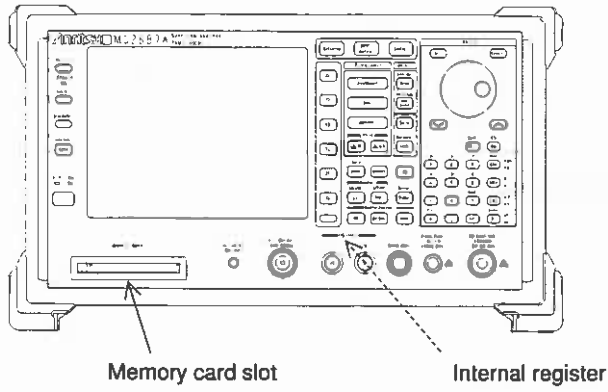

Internal Register

The internal register uses the RAM backed-up by a battery in the spectrum analyzer. Up to 24 parameters and waveform data can be saved. Parameters and waveform data, or parameters only, can be recalled.

Memory Card

The memory card is an interface that corresponds to PCMCIA card type I, 1 slots. Parameters and waveform data can be saved; and parameter and waveform data, or parameters only, can be recalled. Only PC-ATA Flash card is usable. Other cards, such as SRAM can not be used. The PC-ATA Flash card operation is not guaranteed generally.

Saving Parameter and Waveform Data

To save the current parameters and waveform data and title to internal register or memory card, perform the following key operations.

When a title is necessary, enter it in advance. (Refer to Section 11.)

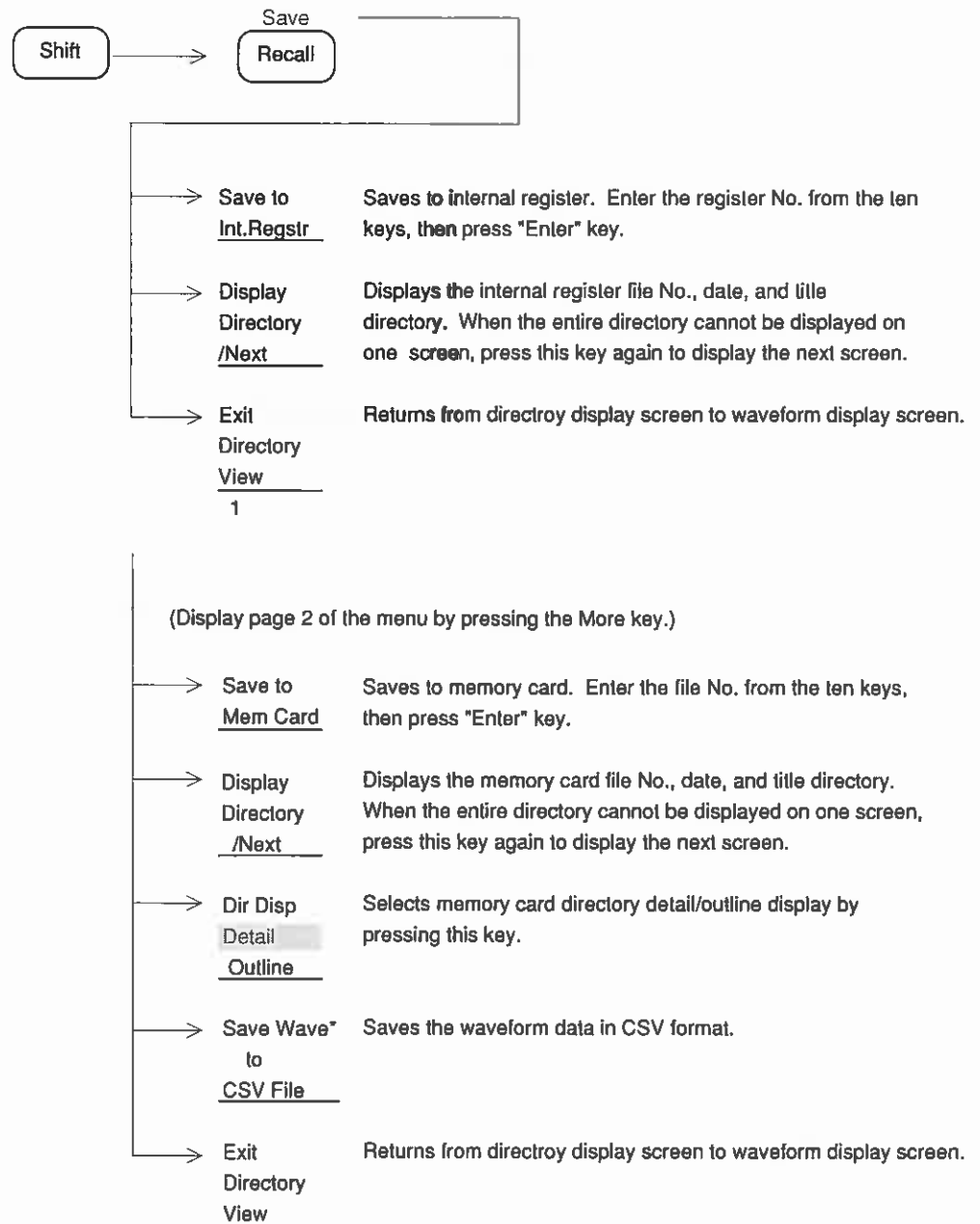

Notes:

1. Since the Save operation overwrites the data written using the same register/file number, check the directory before doing any saving.
2. The number of the internal register is up to 24 parameters. Range of the register No. is from 01 to 24.

<Memory Directory>

No.	Date	Title
01	2000-09-15	Noise Level Measurement
02	2000-09-23	FALL 0923
10	2000-10-10	SPRT 1010
12	2000-11-03	CLTR

Save Int. Reg. NO=

Internal Register Directory Display Screen

Recalling Parameter and Waveform Data

To recall the saved parameters and waveform data or parameters only from internal register or memory card, perform the following key operations.

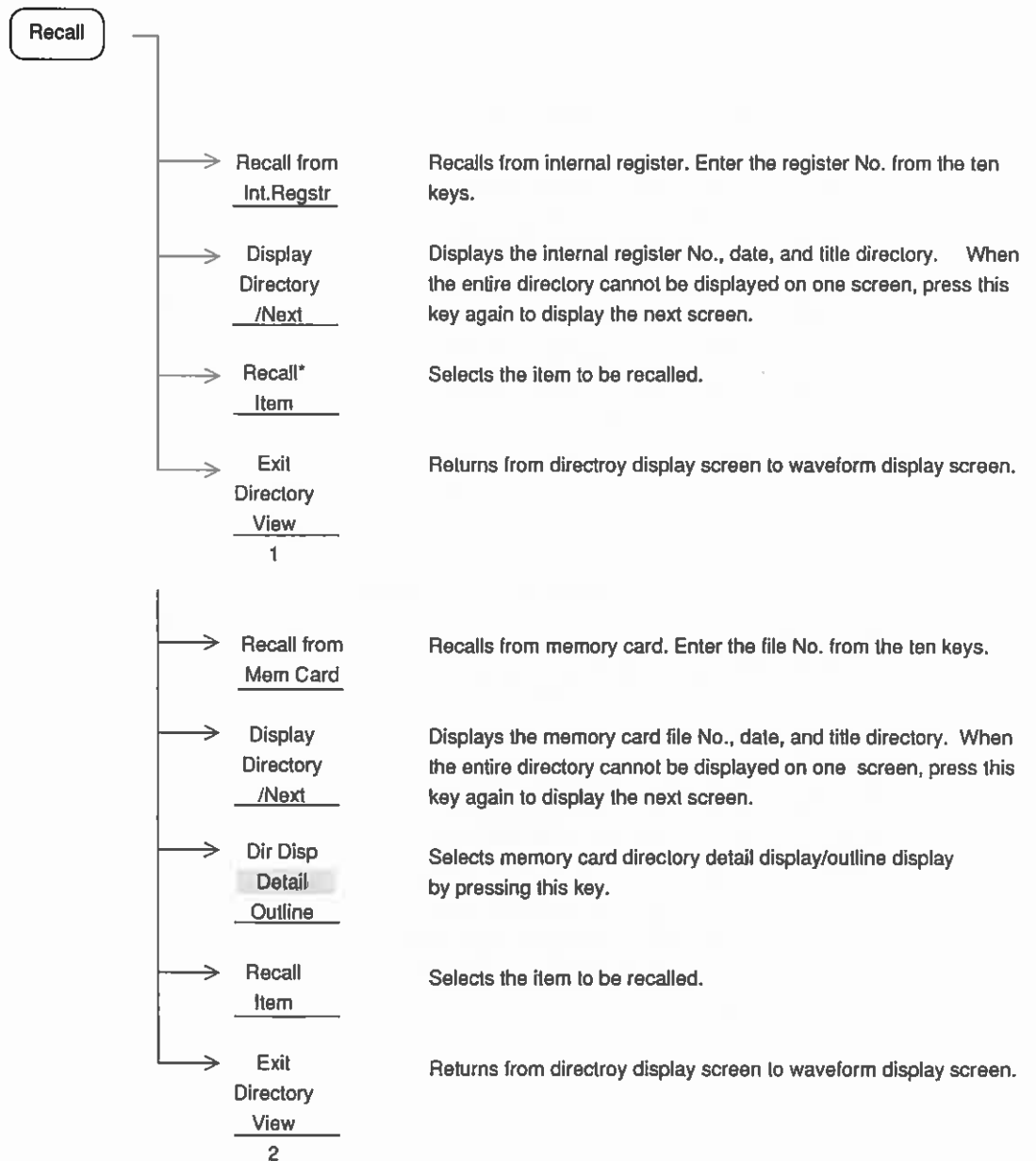

Notes:

- [1] Waveform data should be saved in the View storage mode or in the state while stopped after a single sweep. Resweep immediately after recall clears from the screen display the data saves during continuous sweep.
- [2] The Cumulative and Overwrite storage modes allow the last-swept waveform data to be saved.

<File Directory>		Recall
Media: Mem Card-1		
Unused Area: 205 824 byte		
31 Files in \MS2683A\SPEANA\TRACE		
Name	Title	Bytes Date Protect
TRACE001	DAT Carrier Power Measure	2608 2000-05-16 09:04 Off
TRACE002	DAT Power steps Measure	2608 2000-05-16 09:04 Off
TRACE003	DAT PvsT full frame Measure	2608 2000-05-16 09:04 Off
TRACE004	DAT PvsT full slot Measure	2608 2000-05-16 09:04 Off
TRACE005	DAT PvsT top 10dB Measure	2608 2000-05-16 09:04 Off
Recall File No =		

(Detail)

<File Directory>		Recall
Media: Mem Card-1		
Unused Area: 205 824 byte		
31 Files in \MS2683A\SPEANA\TRACE		
No.	Date	Title
001	2000-05-16	Carrier Power Measure
002	2000-05-16	Power steps Measure
003	2000-05-16	PvsT full frame Measure
004	2000-05-16	PvsT full slot Measure
005	2000-05-16	PvsT top 10dB Measure
006	2000-05-16	PvsT Rising edge Measure
007	2000-05-16	PvsT Falling edge Measur
008	2000-05-16	Intermod measure (carr
009	2000-05-16	BS Tx band(800kHz abov
010	2000-05-16	BS Tx band(800kHz belo
011	2000-05-16	BS Rx band(3rd) measure
Recall File No =		

(Outline)

Memory Card Directory Display Screen

Selecting Recall Item

Select the item to be recalled by performing the following key operations.

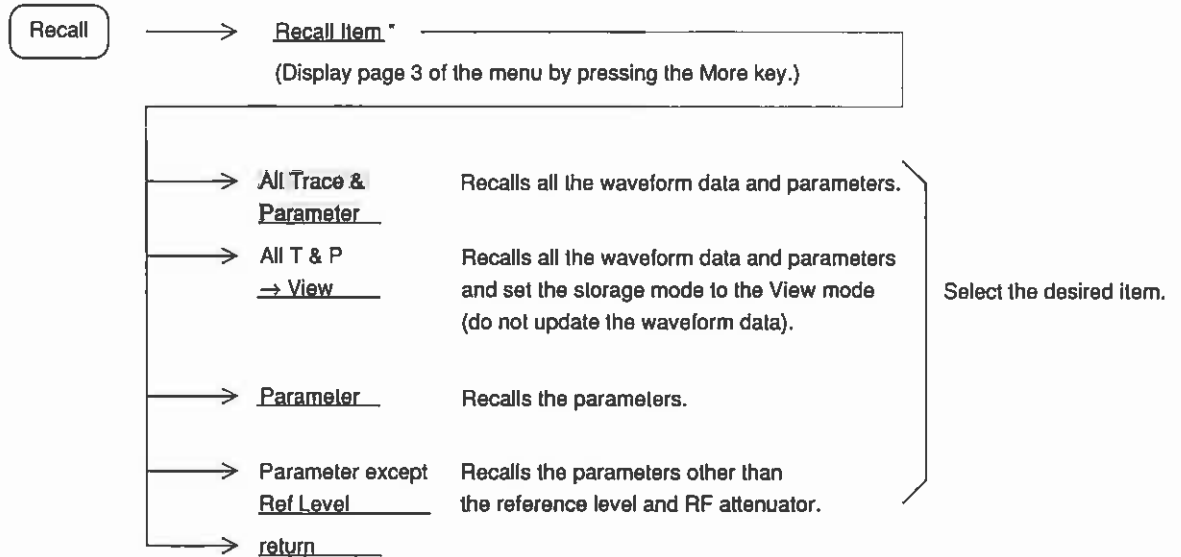

File Deletion and Write Protect

To delete a file and set write protect, perform the following key operations.

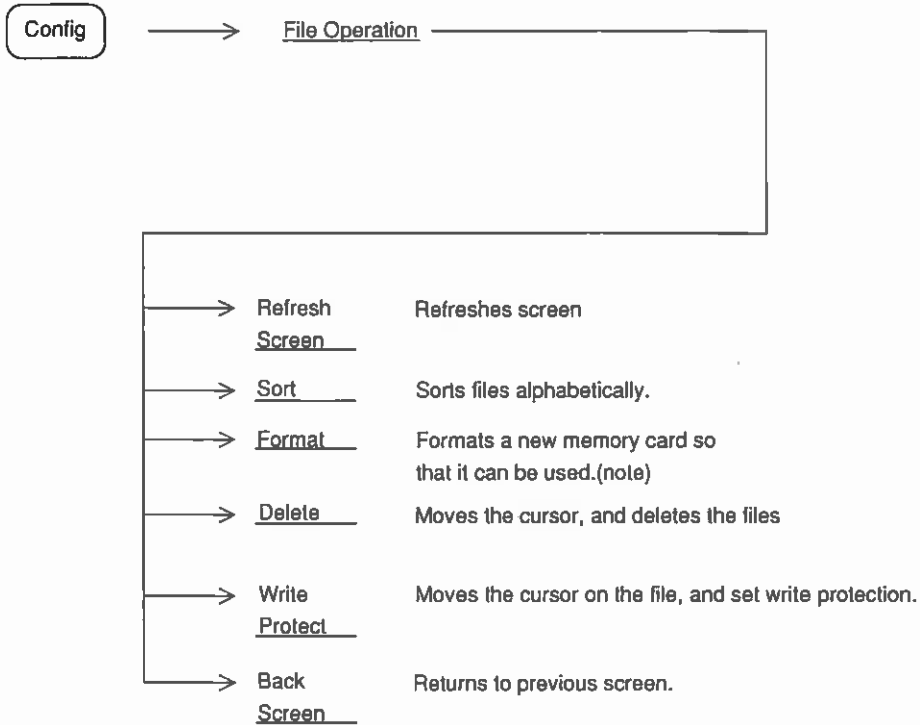

- Note:**
1. When a memory card is formatted, all the file contents are deleted even if they are write protected.
 2. The operation above releases write protection of the protected files.
 3. Write-protected files are displayed with "protect" in the memory card directory displayed set to "on" and cannot be saved or deleted.
 4. Change the directory by following operation:
 - Moves the cursor: Turn the knob
 - Turn the page Press the step keys.
 - Change to parent directory Move the cursor to ..(upper line), and press the **Set** or **Enter** key.
 - Change to sub directory Move the cursor to the *** dir, and press the **Set** or **Enter** key.

Section 11 Copy

This section describes the Copy function for hard-copying the contents displayed on the screen.

Direct Plotting	11-3
Connecting to Printer	11-3
Selecting a Printer and BMP File	11-4
Selecting a Printer	11-5
Executing Hard Copy	11-6
Saving Screen Image Data to Memory Card	11-7
Selecting Memory Card	11-7
Executing Save	11-7
Displaying the Screen Image Data on PC	11-8
Entering a Title	11-9

Direct Plotting

The spectrum analyzer can output a hard copy of the screen as follows:
Using a printer via parallel interface.

However, the printer is limited to HP815C compatible model and ESC/P compatible types.

Connecting to Printer

Connect the spectrum analyzer and printer as shown below.

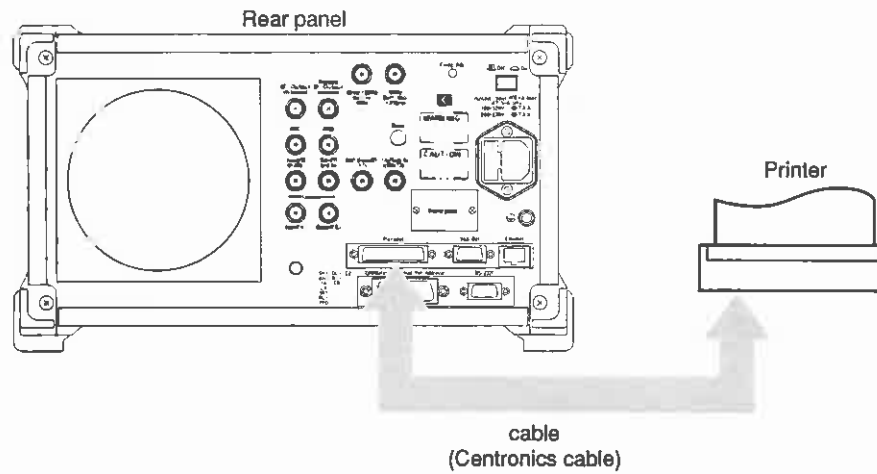

Selecting a Printer and BMP File

To select printer, set-up the printer, feed the paper, stop printing, etc., perform the following key operations:

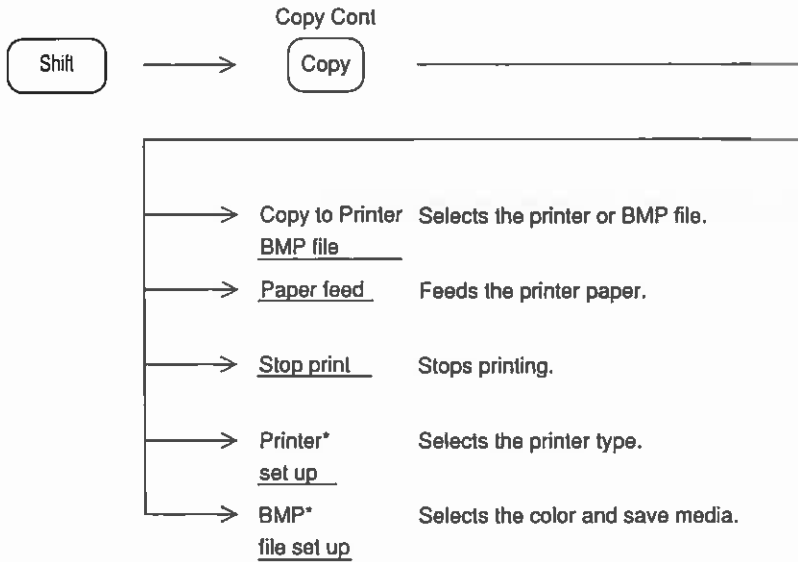

Selecting a Printer

To select the printer to use, perform the following key operations:

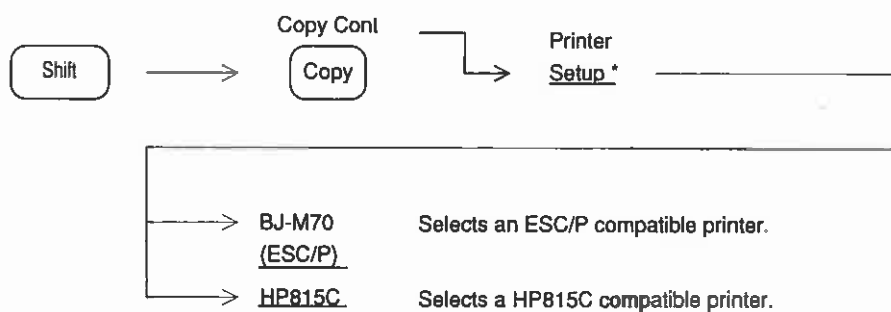

Executing Hard Copy

Start hard copy by pressing the ^{Copy Cont}  key. When the screen-image data saving is selected, saves the data to the memory card.

Notes:

- Set the printer or plotter to the ON LINE mode.
- Immediately after setting the copy execution, the sweep stops for a few seconds because of editing process of the data. After restarting the sweep, and beginning the printing at printer/plotter; the parameters etc. can be set. After completion of the current copying, perform the next copying.

Saving Screen Image Data to Memory Card

The screen display contents can be saved to a memory card as a BMP-format (standard image data format of the Windows) file. After saving, the file in the memory card can be opened on the Windows of PC.

The PC-ATA Flash card operation is not guaranteed generally.

Selecting Memory Card

To select the screen-image-data saving function and the memory-card slot at the front panel, perform the following key operations:

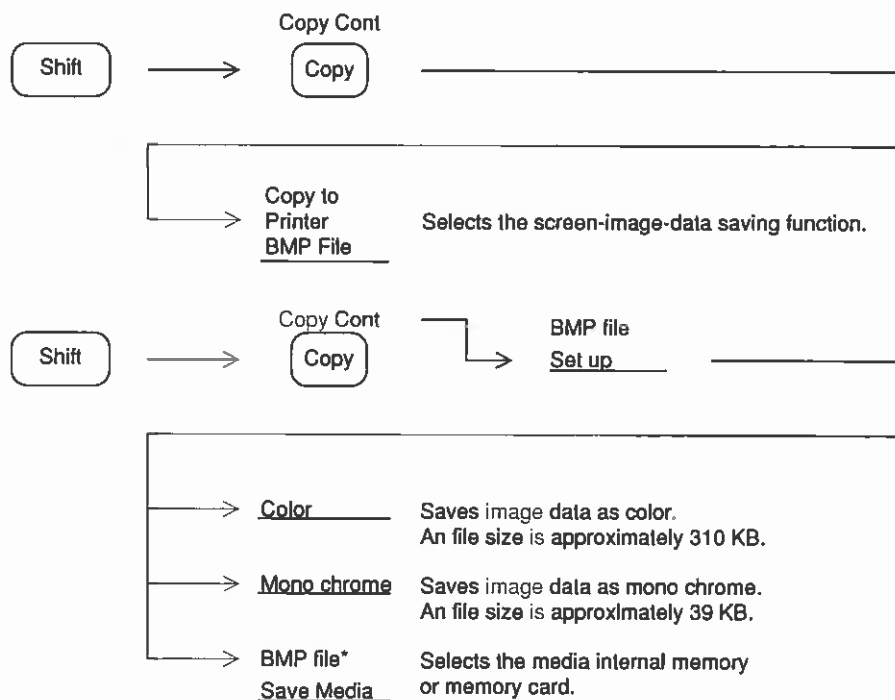

Executing Save

Saves the screen-image data to a memory card by pressing the **Copy** key (labeled **Copy Cont**).
File name to be saved is automatically numbered.

When the menu is displayed in this saving mode, it is also saved as it is.

Use the memory card which is formatted by the spectrum analyzer.

Displaying the Screen Image Data on PC

The saved screen image data can be displayed on a personal computer (PC) with a tool on PC (ex. the paint brush of Windows).

The saved files on a memory card are in the directory as shown below.

¥MS2681A/MS2683A/MS2687A/MS2687B¥COPY¥COPY001.BMP

↑
File No.

Entering a Title

A character string of up to 23 letters can be displayed in the title display field at the top of the screen. To input a title character string, perform the following key operations:

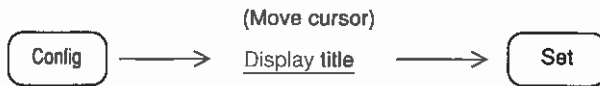

<p>Title:Fre <u>q</u> Count On</p> <div style="border: 1px solid black; padding: 5px; margin: 10px auto; width: 80%;"> <p>ABCDEFGHIJKLMNOPQRSTUVWXYZ abcdefghijklmnopqrstuvwxyz 0123456789-+*/=!"#\$%&'()-` / @ [] { } : ; . . < > ? _</p> </div> <p>Select the characters by turning the rotary knob. After setting the title, press the [Sel] key.</p>	<table border="1"> <thead> <tr> <th colspan="2">Edit</th> </tr> </thead> <tbody> <tr> <td style="text-align: center;">←</td> <td>Moves Title cursor to the left.</td> </tr> <tr> <td style="text-align: center;">→</td> <td>Moves Title cursor to the right.</td> </tr> <tr> <td style="text-align: center;">Enter</td> <td>Inserts one character.</td> </tr> <tr> <td style="text-align: center;">Insert</td> <td>Inserts one character</td> </tr> <tr> <td style="text-align: center;">Delete</td> <td>Deletes one character</td> </tr> <tr> <td style="text-align: center;">Clear</td> <td>Clears title</td> </tr> </tbody> </table>	Edit		←	Moves Title cursor to the left.	→	Moves Title cursor to the right.	Enter	Inserts one character.	Insert	Inserts one character	Delete	Deletes one character	Clear	Clears title
Edit															
←	Moves Title cursor to the left.														
→	Moves Title cursor to the right.														
Enter	Inserts one character.														
Insert	Inserts one character														
Delete	Deletes one character														
Clear	Clears title														

Title Edit Screen

To display the title and time, perform the following key operations.

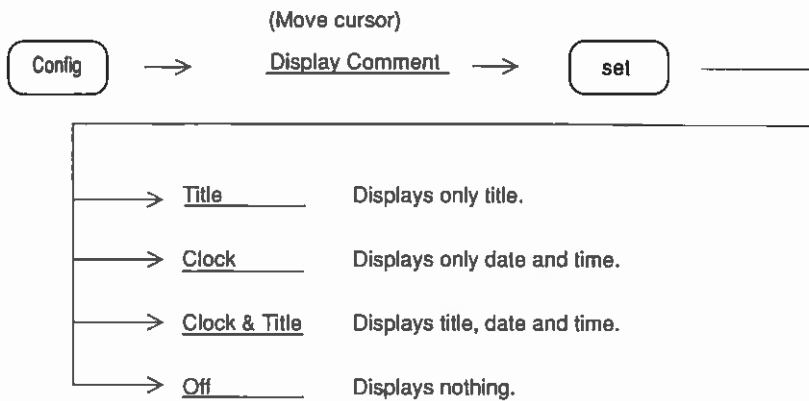

Section 11 Copy

Section 12 Measurement

This section describes the Measure key and the operating procedure for actual measurement examples.

Refer to the measurement example below, for the actual measurement procedure.

Measure Measurement Function	12-3
Frequency Measurement Function	12-4
Measuring Noise Power	12-4
Measuring C/N Ratio	12-5
Channel Power	12-5
Measuring Occupied Bandwidth	12-5
Measuring Adjacent Channel Leakage Power	12-6
Pass/Fail Judgment by Mask	12-7
Pass/Fail Judgment by Time Template	12-8
Measuring Burst Average Power	12-8
Measurement Examples	12-9
Example of C/N Ratio Measurement	12-9
Example of Power (Noise) Measurement (Frequency Domain, Continuous Wave)	12-11
Example of Channel Power Measurement (Frequency Domain, Continuous Wave)	12-13
Example of Power Measurement (Time Domain)	12-15
Example of Time Domain Peak Detection	12-18
Example for Occupied Frequency Bandwidth (Burst Wave)	12-19
Example of Spurious Radiation Strength Measurement (Burst Wave)	12-21
Examples of Carrier-Off Leakage Power Measurement (Time Domain Spectrum Analysis)	12-24
Example of Measurement of Adjacent Channel Leakage Power	12-29
Example of Memory Card Use	12-31
Example of Time Template Creation (PHS Transmit Signal)	12-32
MASK Creation in Frequency Domain Mode	12-37

Measurement Function

Various application measurements can be selected by performing the following key operations.

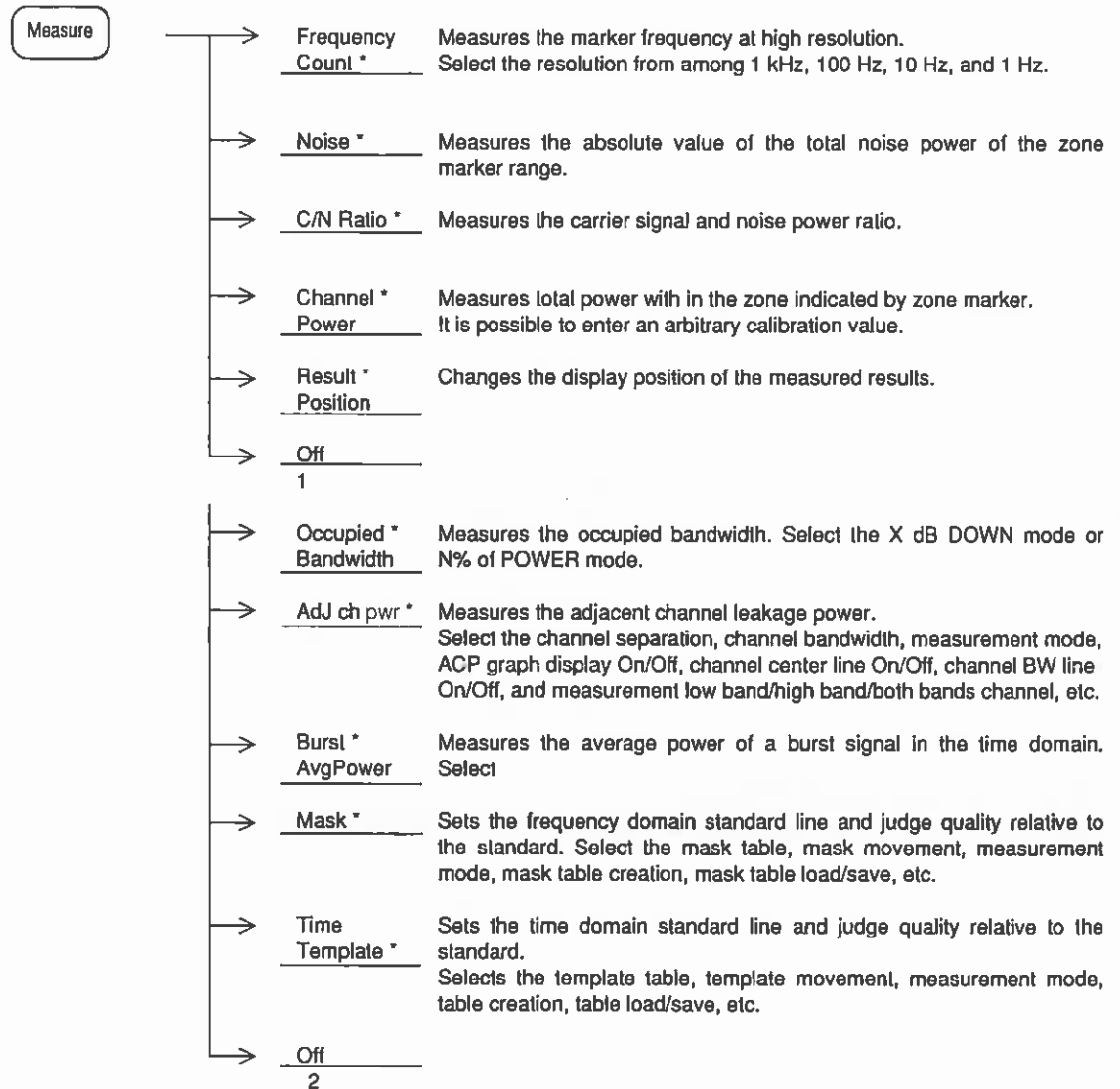

Frequency Measurement Function

To measure the marker frequency at high resolution, perform the following key operations.

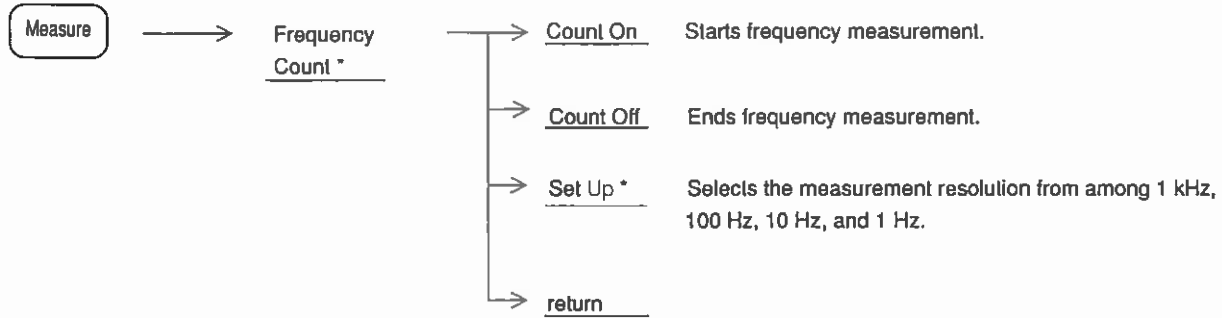

Note:

- If the RBW is too small compared to frequency span, it takes more times to count because of the internal automatic tuning operation. Conversely, if the RBW is too large and another signal exists near the measurement signal (within the 20 multiple of the RBW), the automatic operation may catch it. So, select the appropriate RBW value.
- In the following cases, the frequency may not be counted correctly because of the undesired adjacent noise.
 - [1] Signal level is less than -30 dB from reference level.
 - [2] Level difference between signal and noise is less than 20 dB.
- This cannot be used with Option 04: Digital RBW.

Measuring Noise Power

To measure the total noise power of the zone marker range, perform the following key operations.

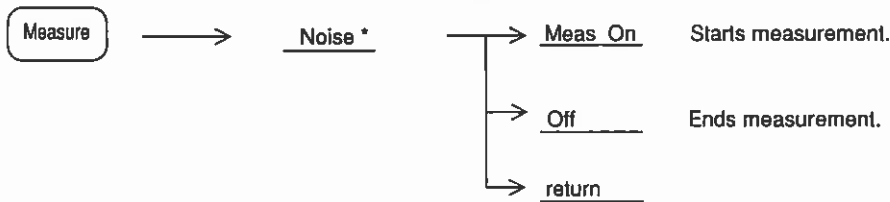

Measuring C/N Ratio

To measure the C/N ratio, perform the following key operations:

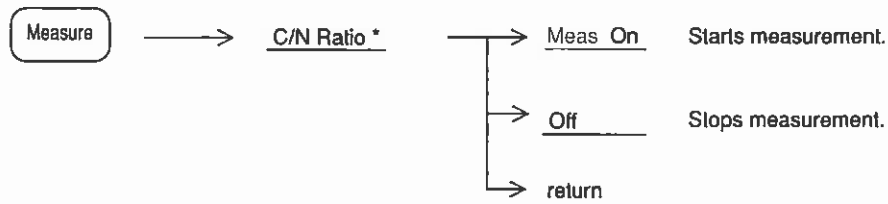

Channel Power

Total power with in the channel specified by zone marker is measured.

It is possible to set an arbitrary calibration value.

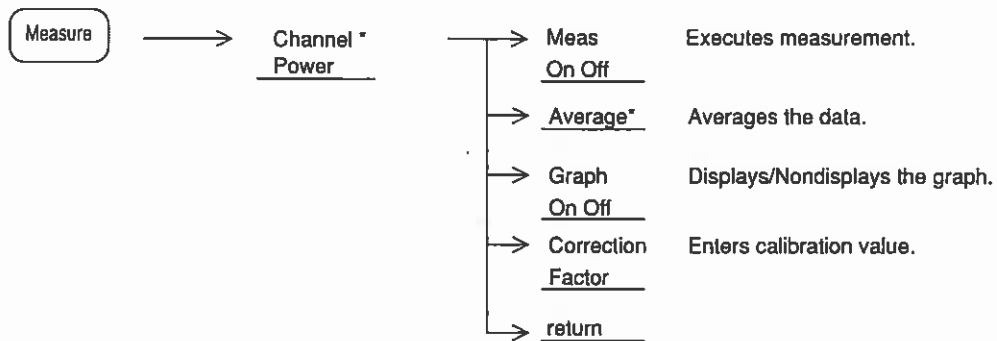

Measuring Occupied Bandwidth

To measure the occupied bandwidth, perform the following key operations:

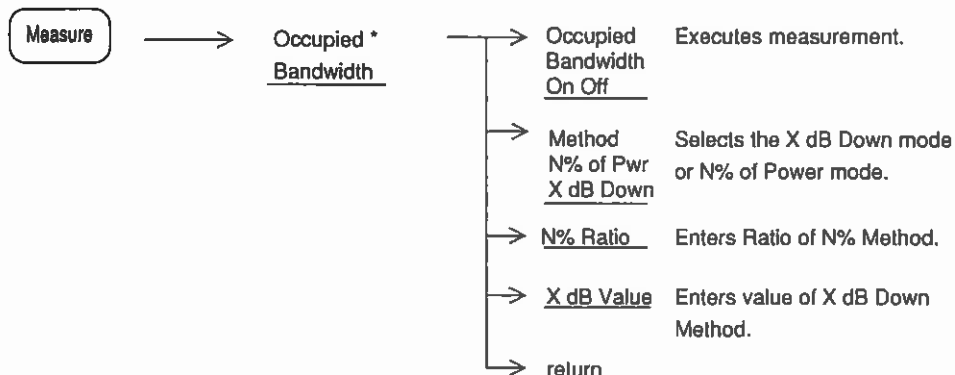

Measuring Adjacent Channel Leakage Power

To measure the adjacent channel leakage power, perform the following key operations:

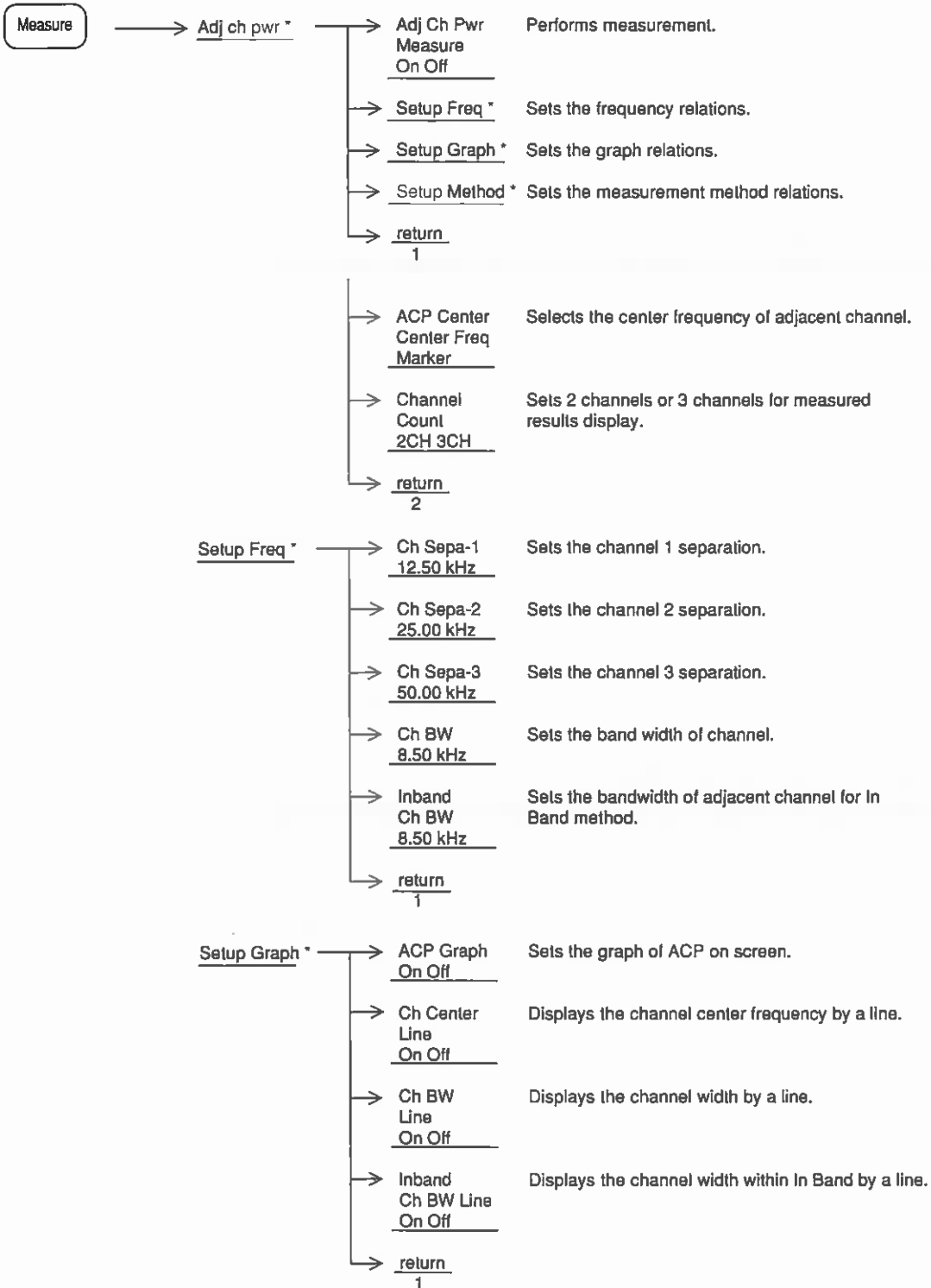

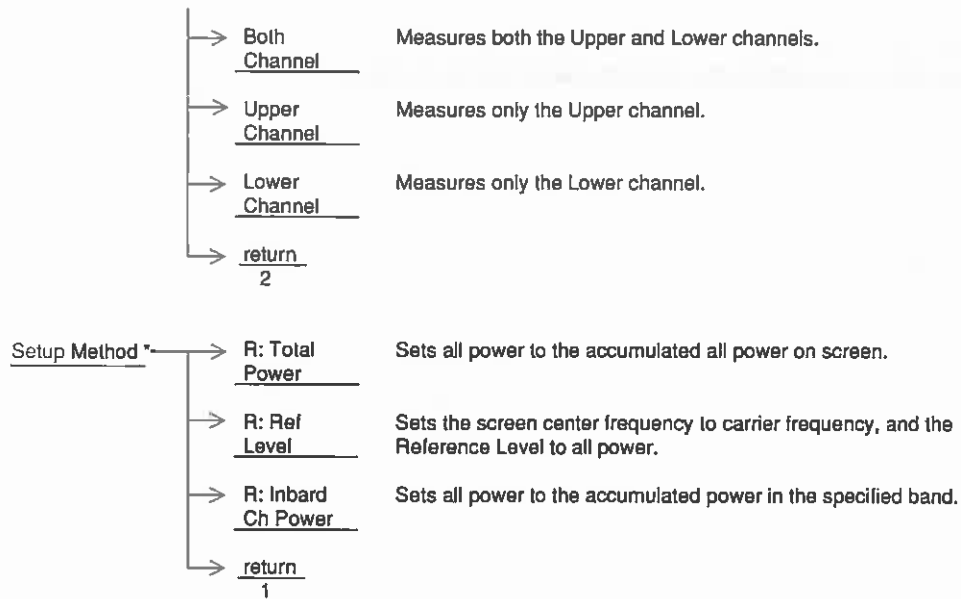

Pass/Fail Judgment by Mask

To perform pass/fail judgment relative to the frequency domain standard line (mask), perform the following key operations.

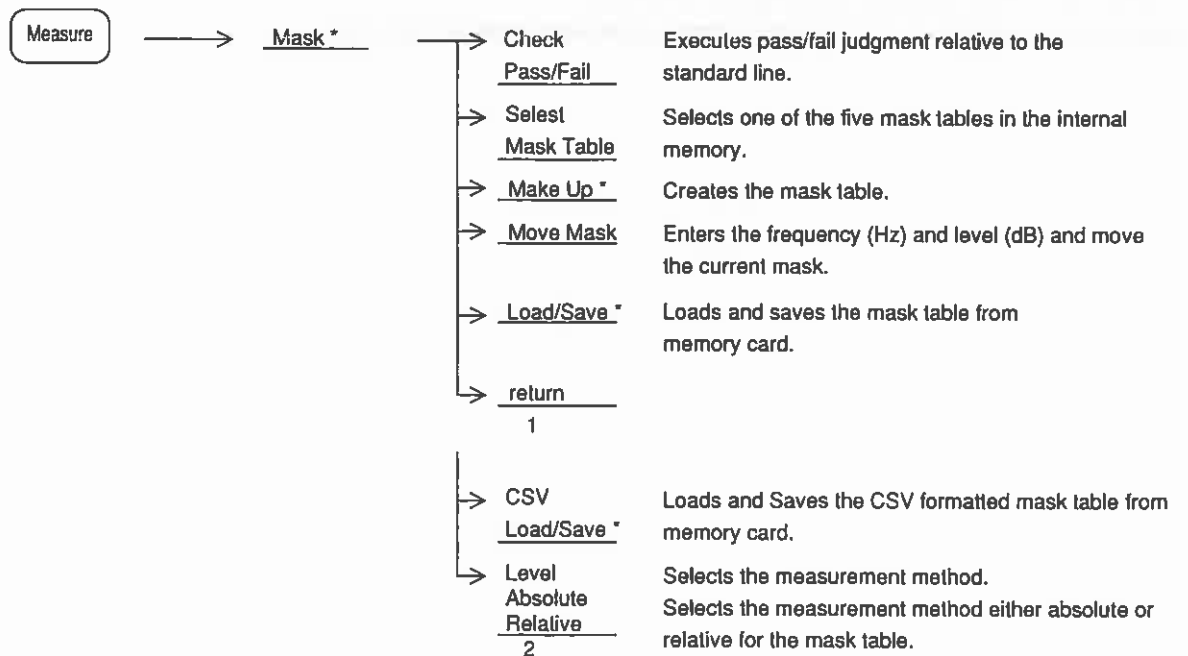

Pass/Fail Judgment by Time Template

To perform pass/fail judgment by time domain template, perform the following key operations:

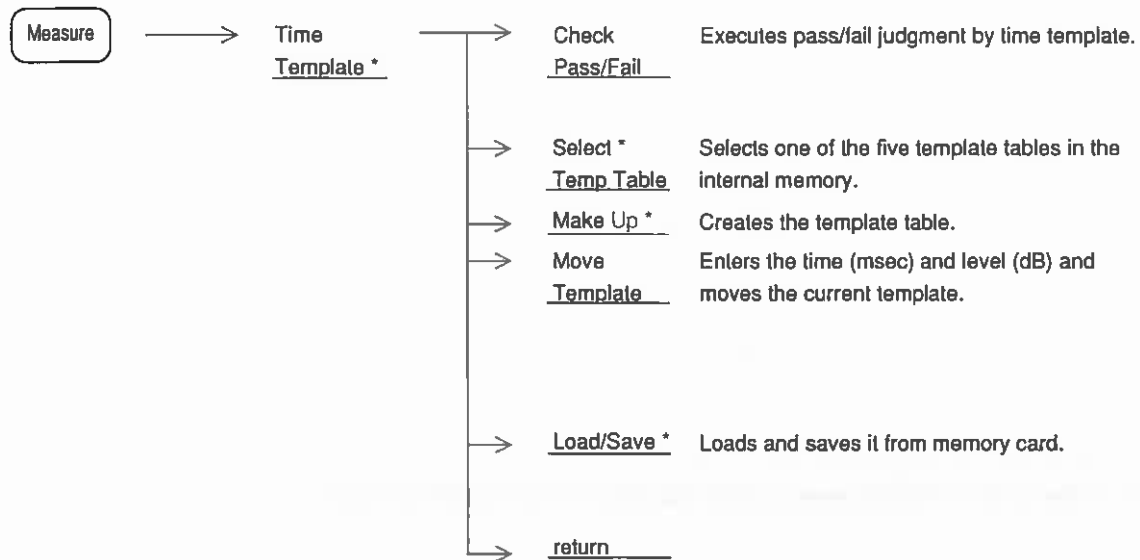

Measuring Burst Average Power

To measure the average power of a burst wave in the time domain mode, perform the following key operations:

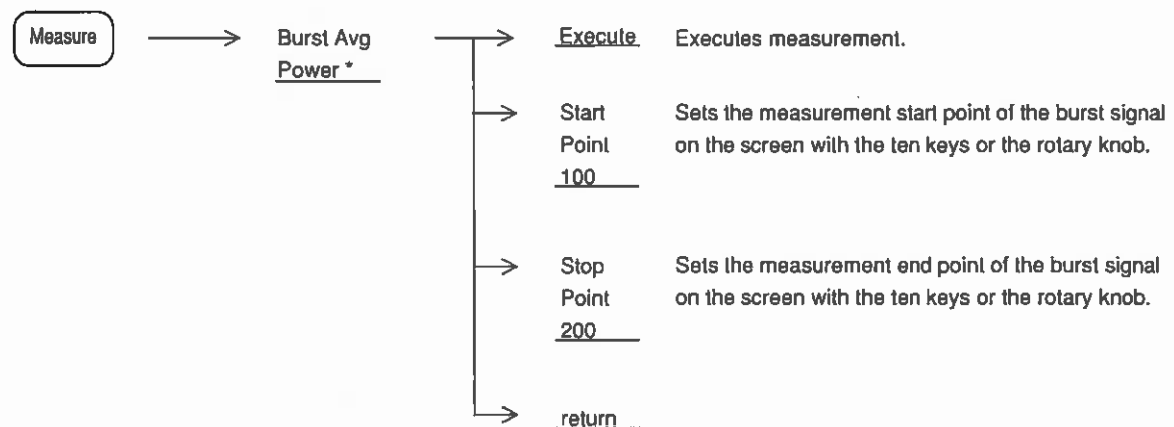

Measurement Examples

The following describes the measurement block diagram and measurement operating procedure of actual measurement examples.

In the measurement examples, [] indicates a panel key and F*: << >> indicates a soft key.

Example of C/N Ratio Measurement

- In C/N measurement, set the detection mode set to the Sample mode, unless specified otherwise. (Pressing [A,B] until F1: <<Trace A>> is displayed, then set the mode by pressing F1: <<Trace A>>, F6: <<Detection>>, and F3: <<Sample>>.)

(1) Measurement block diagram

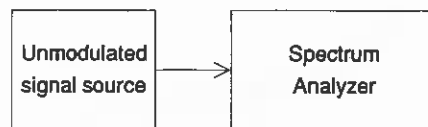

- Center frequency : 1.9 GHz
- Offset frequency : 100 kHz

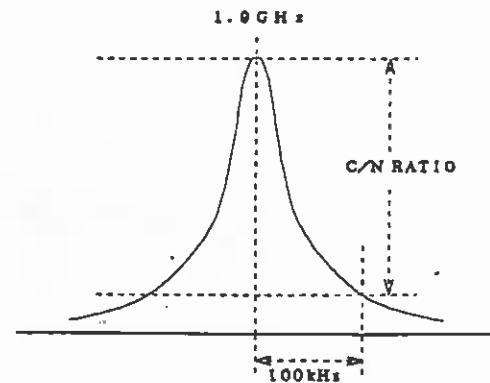

(2) Measurement procedure

Step	Procedure
1	[Preset], F1: <<Preset All>>
2	Span frequency setting : [Span], [4]m [0], [0], [kHz] Set to 3 or 4 times the offset frequency. (Here, the span frequency was set to 400 kHz.)
3	Reference level setting : [Amplitude], [2], [0], [dBm]
4	Center frequency setting: [Frequency], [1], [.] [9], [GHz]
5	RBW setting : [BW], F: <<RBW Manual>> [3], [kHz]
6	Marker setting : [Marker], F5: <<Zone Width>>, F1: <<Spot>>
7	Peak (frequency, level) setting: After 1 sweep, press [→CF] and [→RLV].
8	Marker position setting : [Marker], F2: <<Delta Marker>>, [1], [0], [0], [kHz] (Becomes the offset frequency.)
9	C/N ratio measurement: : Press [Measure] until F3: <<C/N Ratio Measure>> is displayed, then press F3: <<C/N Ratio Measure>> and F1: <<Meas On>>. Each time sweep is refreshed, the measurement result is displayed at the upper left-hand corner of the screen.

- ★ Measurement result example: -123.77 dBc/Hz
- ★ When wanting to change the offset frequency and make measurement: Press [Marker], then set the offset frequency with the rotary knob or ten keys.
- ★ Change the RBW value and select the best C/N measurement value. Also make the ATT value minimum.

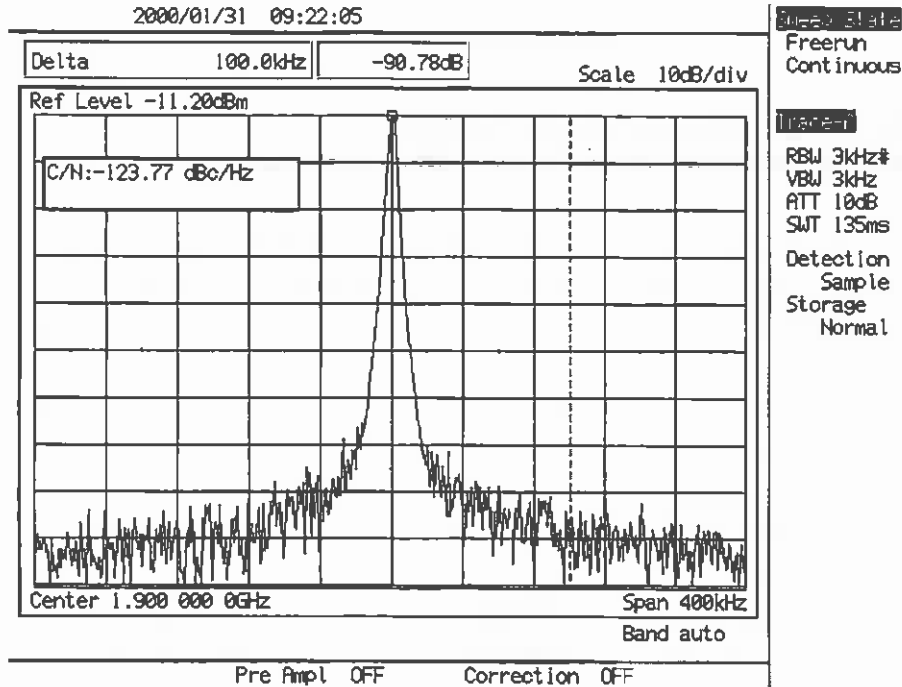

Example of C/N Ratio Measurement

Note:

- When the marker frequency is moved at the reference marker point (peak point of the carrier signal), the measurement result does not become 0 dB. This is because the carrier signal (on which the reference marker is positioned) is considered as a noise, and the detector adds the correction value to the carrier.

Example of Power (Noise) Measurement (Frequency Domain, Continuous Wave)

- When making power measurements, set the detection mode to the Sample mode, unless specified otherwise. When measuring the carrier-off leakage power and adjacent channel leakage power of Japan digital cordless telephone systems (burst wave), set the detection mode to the Pos Peak mode.

(1) Measurement block diagram

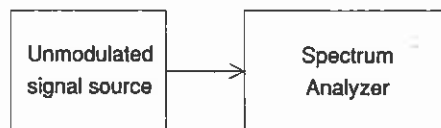

- Center frequency : 800 MHz
- Span frequency width : 400 kHz
- Measurement center frequency : 800.05 MHz
- Measurement frequency bandwidth : 50 kHz

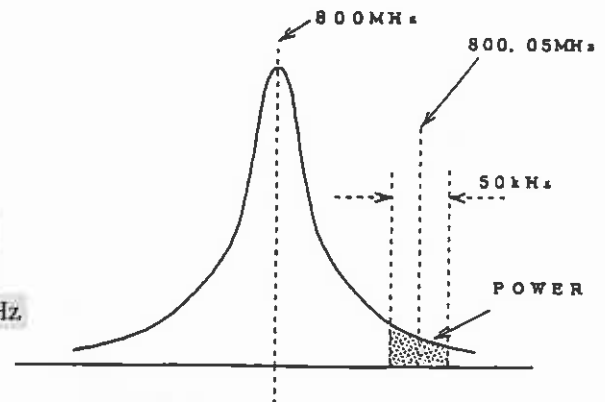

(2) Measurement procedure

Step	Procedure
1	[Preset], F1: <<Preset All>>
2	Span frequency setting : [Span], [4], [0], [0], [kHz]
3	Reference level setting : [Amplitude], [2], [0], [dBm]
4	Center frequency setting : [Frequency], [8], [0], [0], [MHz]
5	RBW setting : [BW], F1: <<RBW Manual>>, [3], [kHz]
6	Peak (frequency, level) setting: After 1 sweep, press [→CF] and [→RLV].
7	Zone center position setting : [Marker], F5: <<Zone Width>>, F1: <<Spot>>, [Marker], F1: <<Normal Marker>>, [8], [0], [0], [·], [0], [5], [MHz]
8	Zone marker width setting : [Marker], F5: <<Zone Width>>, [5], [0], [kHz]
9	Measure power (noise) : Press [Measure] until F2<< Noise Measurement>> is displayed, then press F2: <<Noise Measure>> and F1; <<Meas On>>. Each time sweep is refreshed, <u>the total power value of the zone marker range</u> (measured value) is displayed at the upper left-hand corner of the screen.

- ★ Measurement result example: -69.86 dBm/ch
- ★ When wanting to change the zone marker position and make measurements: After pressing [Marker], set the position (frequency) with the ten keys.
- ★ Applications: *Carrier-off leakage power (PHS) measurement
 *Adjacent channel leakage power (PHS) measurement

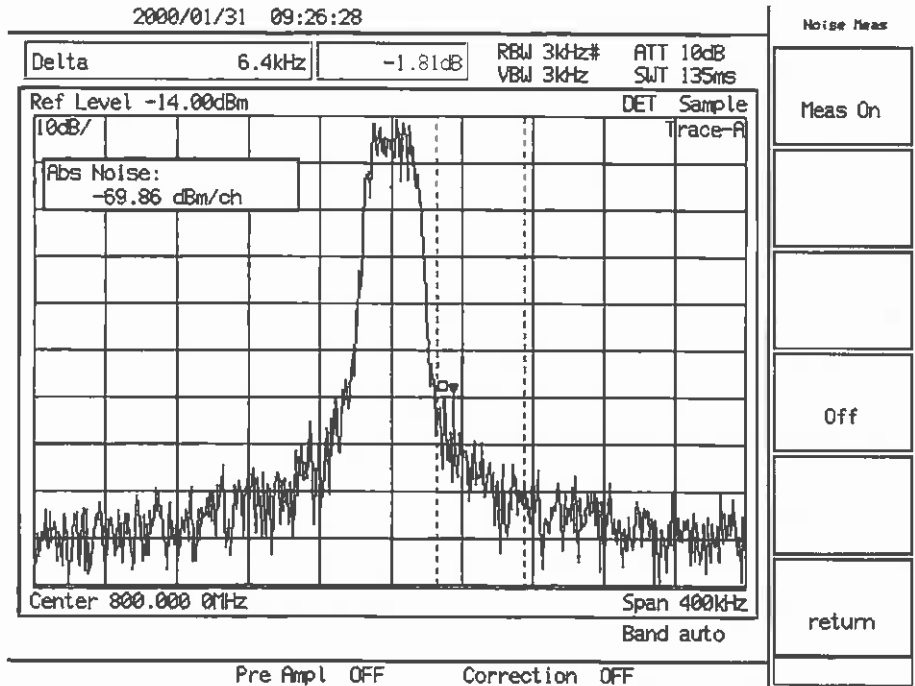

Example of Power (Noise) Measurement

Example of Channel Power Measurement (Frequency Domain, Continuous Wave)

- When making power measurements, set the detection mode to the Sample mode, unless specified otherwise. When measuring the carrier-off leakage power and adjacent channel leakage power of Japan PHS systems (burst wave), set the detection mode to the Pos Peak mode.

(1) Measurement block diagram

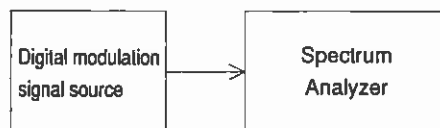

- Center frequency : 800 MHz
- Span frequency width : 400 kHz
- Measurement center frequency : 800.05 MHz
- Measurement frequency bandwidth : 50 kHz

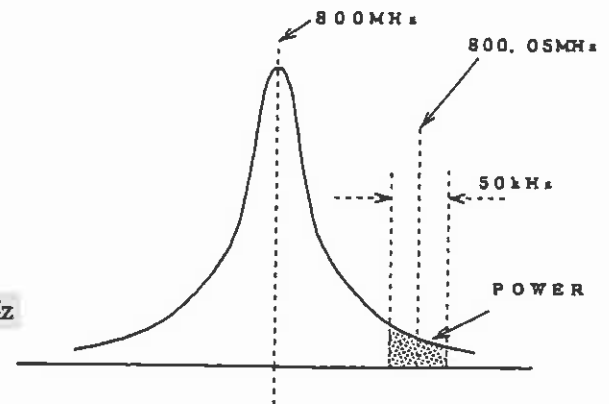

(2) Measurement procedure

Step	Procedure
1	[Preset], F1: <<Preset All>>
2	Span frequency setting : [Span], [4], [0], [0], [kHz]
3	Reference level setting : [Amplitude], [2], [0], [dBm]
4	Center frequency setting : [Frequency], [8], [0], [0], [MHz]
5	RBW setting : [BW], F1: <<RBW Manual>>, [3], [kHz]
6	Peak (frequency, level) setting: After 1 sweep, press [→CF] and [→RLV].
7	Zone center position setting : [Marker], F5: <<Zone Width>>, F1: <<Spot>>, [Marker], F1: <<Normal Marker>>, [8], [0], [0], [.), [0], [5], [MHz]
8	Zone marker width setting : [Marker], F5: <<Zone Width>>, [5], [0], [kHz]
9	Measure Channel Power : Press [Measure] until F4 << Channel Power measure>> is displayed, then press F4: <<Noise Measure>> and F1: <<Meas On>>. Each time sweep is refreshed, <u>the total power value of the zone marker range</u> (measured value) is displayed at the upper left-hand corner of the screen. F5: <<correction factor>>, an arbitrary calibration value can be entered.

- ★ When wanting to change the zone marker position and make measurements: After pressing [Marker], set the position (frequency) with the ten keys.

Example of Power Measurement (Time Domain)

- Find the effective average value of the zone set by the two cursors on the screen.

(1) Measurement block diagram

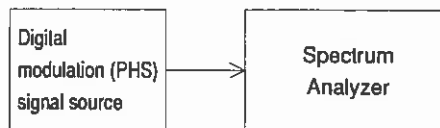

- Center frequency : 1.9 GHz
- Time span : 1 ms

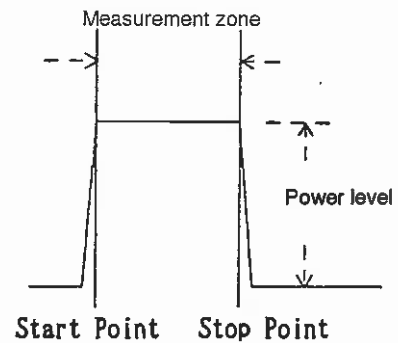

(2) Measurement procedure

Step	Procedure
1	[Preset], F1: <<All>>.
2	Time domain : [Time] or [Span], [0], [Hz]
3	Reference level setting : [Amplitude], [2], [0], [dBm]
4	Center frequency setting : [Frequency], [1], [.] , [9], [GHz]
5	RBW setting : [BW], F1: <<RBW Manual>>, [1], [MHz]
6	VBW setting : [BW], F2: <<VBW Manual>>, [1], [MHz]
7	Time span setting : [Time], F2: <<Time Span>>, [5], [msec]
8	Reference level setting : After one sweep, press [→RLV] and [Amplitude] and raise the reference level about 3 dB with the rotary knob.
9	Time span setting : [Time], F2: <<Time Span>>, [1], [msec]
10	Trigger setting : Select Triggered with [Trig/Gate], F1: <<Triggered>>. F2: <<Trigger Source>>, F1: <<Video>> (Apply <u>video trigger</u>) Select rise with F5: <<Trig Slope>>. Press F1: <<Trig Level>>, then set the trigger level with the rotary knob.
11	Time delay setting : Press [Trig/Gate], F5: <<Delay Time>>, then set the signal waveform to the left of center of the screen with the rotary knob.

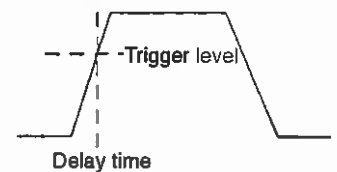

Step	Procedure
12	Single sweep : [Single]
13	Measurement preparation : Press [Measure] until F3: <<Burst Avg Power>> is displayed, then press F3: <<Burst Avg Power>>. Measurement zone setting : Press F3: <<Start Point>>, then set the measurement zone start position with the rotary knob. Press F2: <<Stop Point>>, then set the measurement zone stop position with the rotary knob.
14	Power measurement : F1: <<Execute>>. The measured value is displayed at the top left-hand corner of the screen.

- ★ Example of measurement result: -13.52 dBm, 44.6 μW
- ★ When finding the average power between burst frames, measurement should be performed by setting the measurement zone to the burst frame time.
- ★ Applications:
 - * Spurious radiation strength measurement (PDC, PHS)
 - * Antenna power measurement (PDC, PHS)

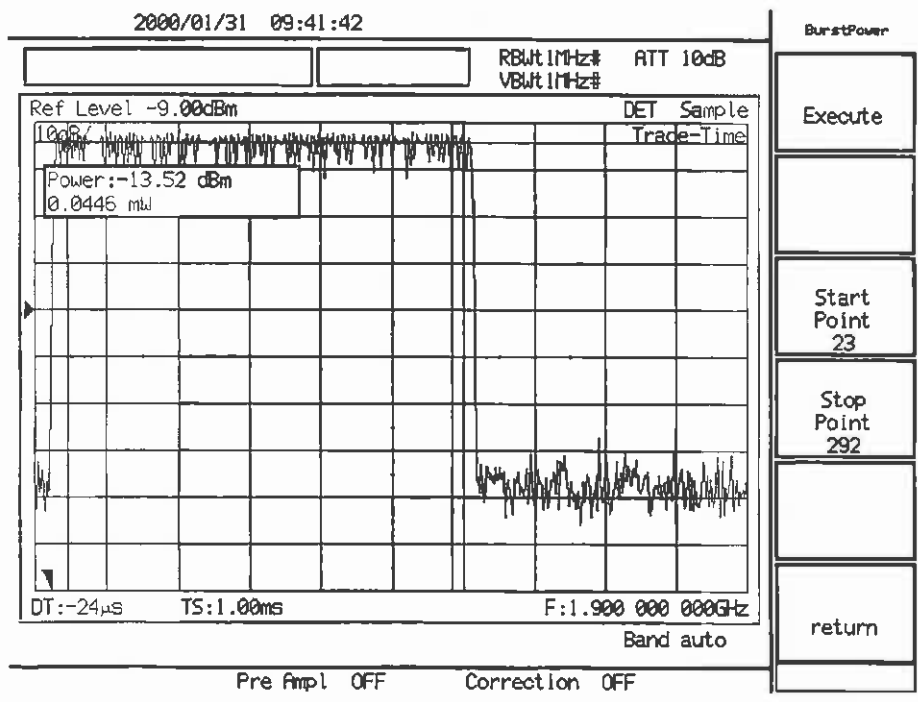
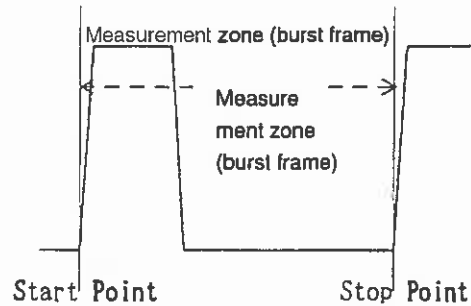

Power Measurement (Time Domain) Example 1

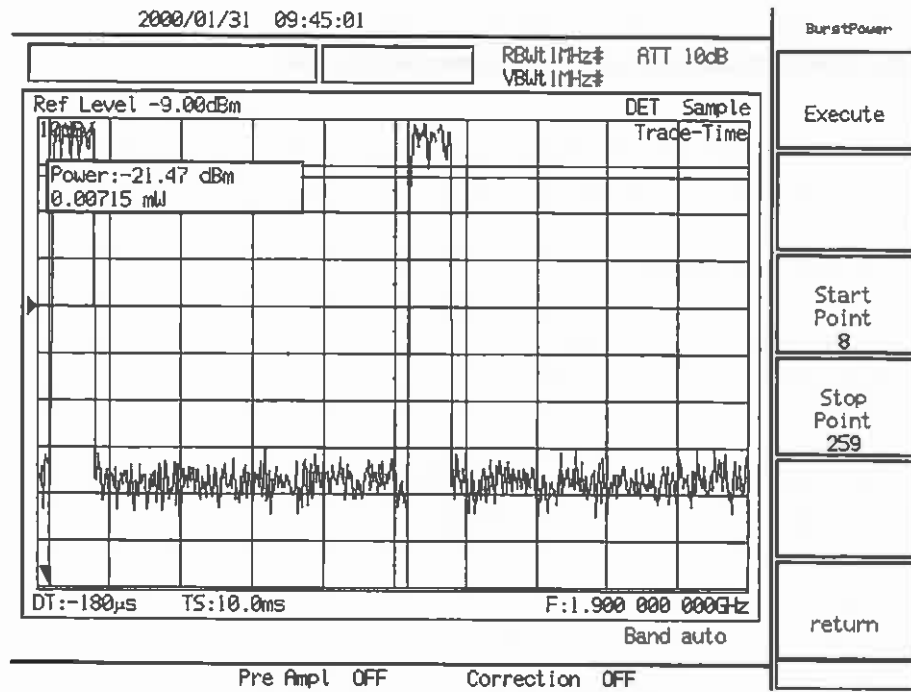

Power Measurement (Time Domain) Example 2

Example of Time Domain Peak Detection

- The time domain detection mode is initially set to the sample detection mode. When the time axis sweep time was set to more than 10 ms, the positive peak detection mode can be selected.

(1) Measurement block diagram

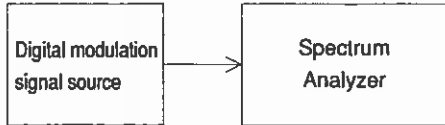

- Center frequency : 1.9 GHz
- Time span : 20 ms

(2) Measurement procedure

Step	Procedure
1	Set in accordance with steps 1 to 9 of the power measurement procedure of paragraph 5 Power Measurement (Time Domain). Set <<Time Span>> of step 7 to 20 ms.
2	DET MODE menu display : Press [Time] until F6: <<Detection>> is displayed. Select F6: <<Detection>>, F2: <<Pos Peak>>.

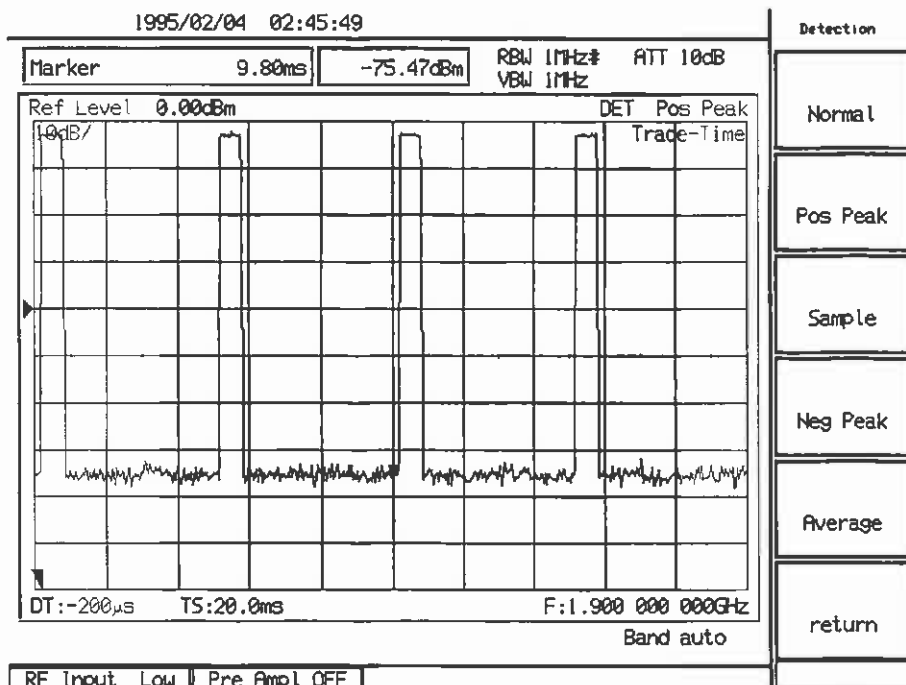

Example for Occupied Frequency Bandwidth (Burst Wave)

- For burst waves, set the detection mode to the Pos Peak mode.

(1) Measurement block diagram

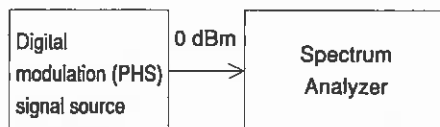

- Center frequency : 1.9 GHz
- Span frequency width : 800 kHz
- RBW : 1 kHz
- VBW : 1 kHz
- Sweep time : 3 s

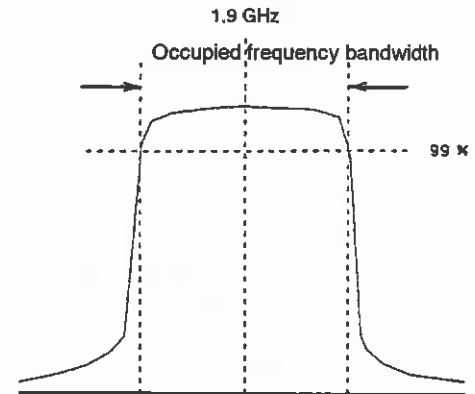

(2) Measurement procedure

Span	Procudere
1	Preset : [Preset], F1: <<Preset All>>
2	Span frequency setting : [Span], [8], [0], [0], [kHz]
3	Reference level setting : [Amplitude], [0], [dBm]
4	Center frequency setting : [Frequency], [1], [.] , [9], [GHz]
5	RBW setting : [BW], F1: <<RBW Manual>>, [1], [kHz]
6	VBW setting : [BW], F2: <<VBW Manual>>, [1], [kHz]
7	Sweep time setting : [Sweep Time], [3], [s]
8	Single sweep : [Sweep]
9	Measurement preparation : Press [Measure] until F1: <<Occupied Bandwidth>> is displayed, then press F1: <<Occupied Bandwidth On>>.
10	99% method setting : Select N% of Pwr with F3: <<Method N% of Pwr>>. F4: <<N% Ratio>>, [9], [9], [Enter]
11	Occupied frequency bandwidth method: The measured value is displayed at the top left-hand corner of the screen.

- ★ Example of measurement result: OccBW: 246.4 kHz, CTR: 1.9000016 GHz
- ★ Application: Occupied frequency bandwidth (PDC, PHS, etc.)

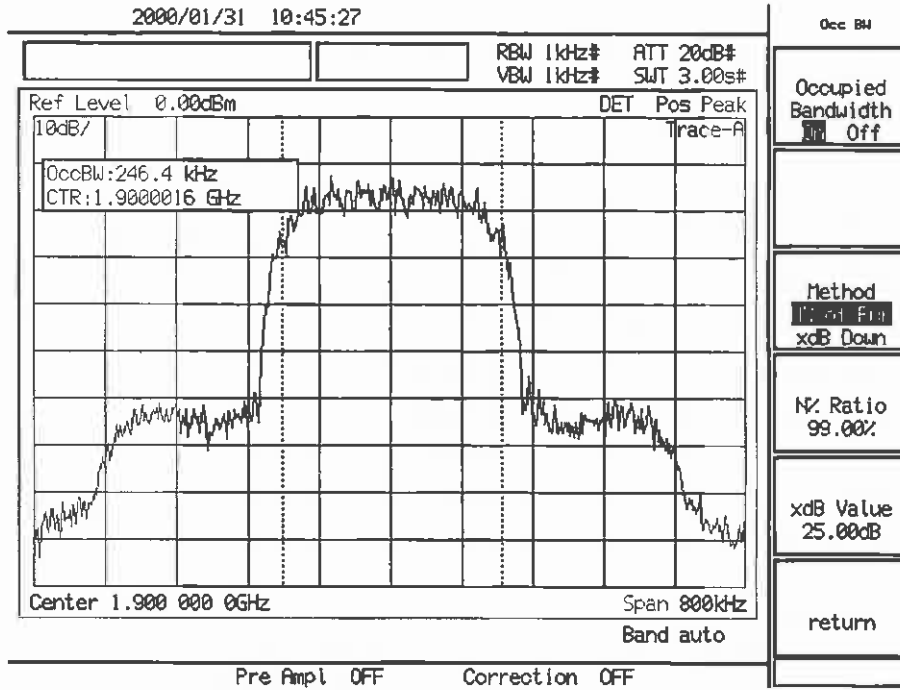

Example of Occupied Frequency Bandwidth Measurement

Example of Spurious Radiation Strength Measurement (Burst Wave)

- For burst waves, set the detection mode to the Pos Peak mode.

(1) Measurement block diagram

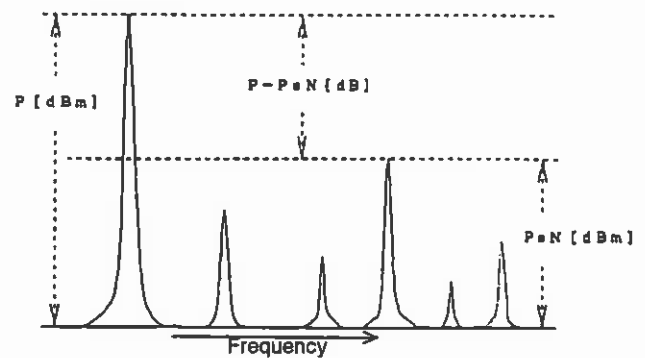
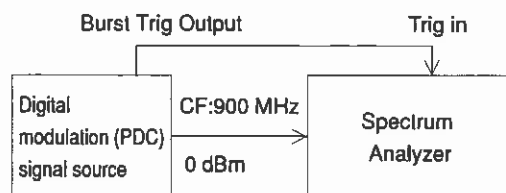

Detection:

- Sweep frequency range : 10 MHz to 3 GHz
- RBW : 1 MHz
- VBW : 1 MHz
- Sweep time : 60 s

Power measurement:

- Span frequency width : 0 Hz
- RBW : 100 kHz
- VBW : 10 kHz
- Sweep time : 20 ms

(2) Measurement procedure

Step	Procedure
(A) Spurious detection	
1	[Preset], F1: <<Preset All>>.
2	Sweep frequency range setting : [Frequency], F3: <<Start Freq>>, [1], [0], [MHz], F3: <<Stop Freq>>, [3], [GHz]
3	Reference level setting : [Amplitude], [5], [dBm]
4	RBW setting : [BW], F1: <RBW Manual>>, < [1], [MHz]
5	VBW setting : [BW], F2: <VBW Manual>>, [1], [MHz]
6	Sweep time setting : [Sweep Time], [6], [0], [s]
7	Single sweep : [Single]

Step	Procedure
8	<p>Multimarker setting : [Shift], [Marker] (Multi Mkr), F2: <<Highest 10>>, F5: <<Marker List>>.</p> <p>Main and spurious lists (frequency and level of each) are displayed.</p> <p>(B) Spurious radiation strength measurement (Example: Assume that the frequency obtained from the list is 1.8 GHz.)</p>
9	<p>Time domain: [Marker], F3: <<Marker Off>>, [Time]</p> <p><u>The following measures the power by the same procedure as power measurement (time domain).</u></p>
10	Center frequency setting : [Frequency], [1], [.] , [8], [GHz]
11	RBW setting : [BW], F1: <<RBW Manual>>, [1], [0], [0], [kHz]
12	VBW setting : [BW], F2: <<VBW Manual>>, [1], [0], [kHz]
13	Press pressing : [Time] until F2: <<Time Span>> is displayed, then press F2: <<Time Span>>, [2], [0], [ms].
14	<p>Trigger setting : Select Triggered with [Trig/Gate], F1: <<Triggered>>.</p> <p>Select Rise with F2: <<Trigger Slope>>, F3: <<External>>, F1: <<-10 to 10V>>, F5: <<Trig Slope>>.</p> <p>F4: <<Trig Level>>, [2], [V]</p>
15	Press : [Trig/Gate], F5: <<Delay Time>>, then set Delay Time with the rotary knob so that the signal waveform moves to the left of center of the screen.
16	Single sweep : [Single]
17	Measurement preparation : Press [Measure] until F3: <<Burst Avg Power>> is displayed, then press F3: <<Burst Avg Power>>.
18	<p>Measurement zone setting : Press F3: <<Start Point>>, then set the measurement zone start position with the rotary <u>knob</u>.</p> <p>Press F4: <<Stop Point>>, then set the measurement zone stop position with the rotary <u>knob</u>.</p>
19	Power measurement : F1: <<Execute>>. The measured value (P_{SN}) is displayed at the top left-hand corner of the screen.

★ Example of measurement result: -50.96 dBm, 0.00000802 mW

Step	Procedure
	(C) Spurious ratio strength ratio (relative to carrier power)
20	Set the center frequency to the carrier frequency and measure the carrier power (P) by executing steps 15, 16, 17, and 18.
	Spurious radiation strength ratio: $(P_{SN}) - (P)$ [dB]

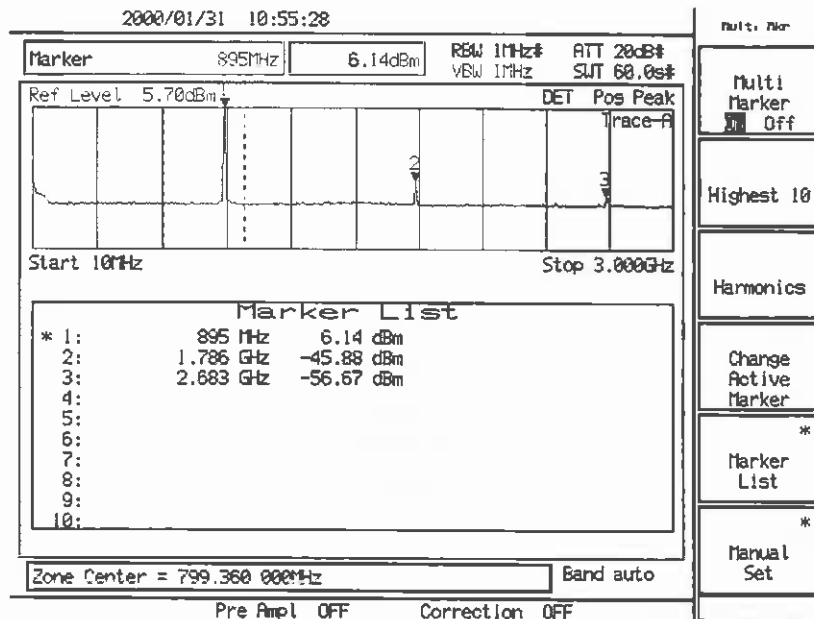

Example of Spurious Detection

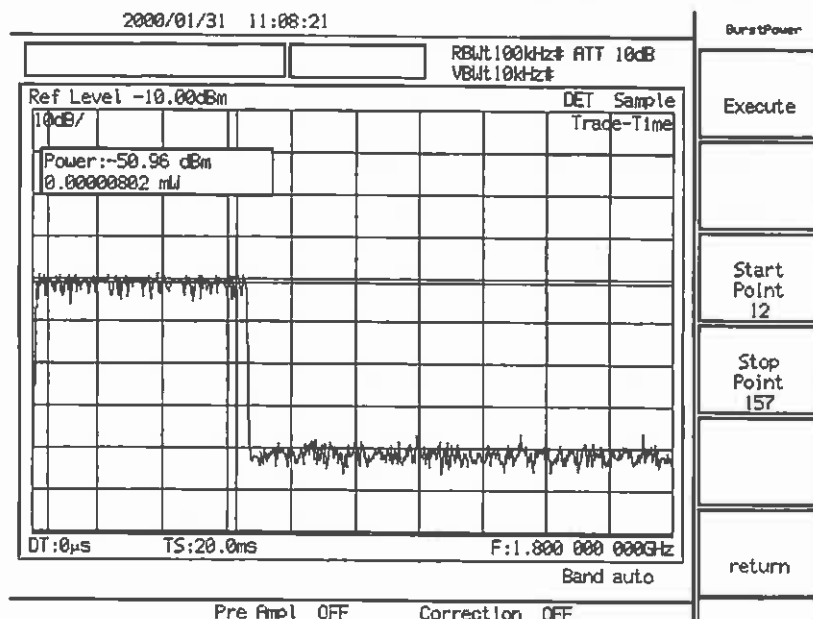

Example of Spurious Strength measurement

Examples of Carrier-Off Leakage Power Measurement (Time Domain Spectrum Analysis)

Example 1 When external trigger used

- Set the detection mode to the Pos Peak mode.

(1) Measurement block diagram

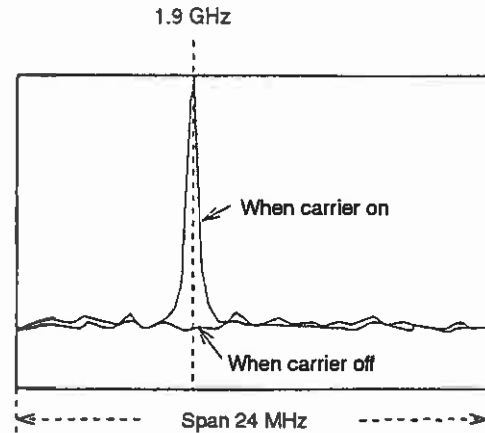
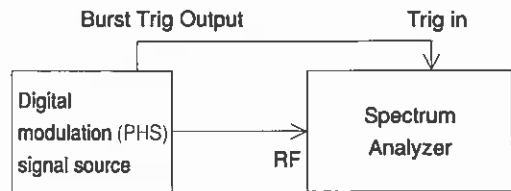

- Input signal frequency : 1.9 GHz
- Center frequency : 1906.55 MHz
- Span frequency width : 24 MHz
- RBW : 300 kHz
- VBW : 3 MHz
- Sweep time : 4 s

(2) Measurement procedure

Step	Procedure
1	[Preset], F1: <<Preset All>>
2	Time domain setting : [Time]
3	Reference level setting : [Amplitude], [2], [0], [dBm]
4	Center frequency setting : [Frequency], [1], [.] , [9], [GHz]
5	RBW setting : [BW], F1: <<RBW Manual>>, [1], [MHz]
6	VBW setting : [BW], F2: <<VBW Manual>>, [1], [MHz]
7	Time domain setting : [Time], F2: <<Time Sweep>>, [5], [msec]
8	Reference setting : After one sweep, press [→RLV].
9	Trigger setting : Select Triggered with [Trig/Gate], F1: <<Triggered>> and select Rise with F2: <<Trigger Source>>, F3: <<External>>, F1: <<-10 to 10>>, and F5: <<Trig Slope>>. F4: <<Trig Level>>, [2], [V]

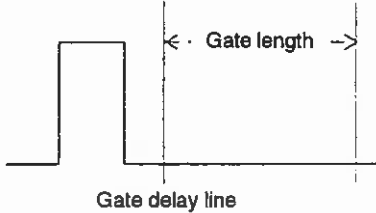
Step	Procedure	
10	RBW setting	: [BW], F1: <<RBW Manual>>, [3], [0], [0], [kHz]
11	VBW setting	: [BW], F2: <<VBW Manual>>, [3], [MHz]
12	Gate setting	: Press [Trig/Gate] until F1: <<Gate Sweep> is displayed. Select On with F1: <<Gate Sweep>>. F2: <<Gate Setup>>, F1: <<Gate Delay>>, and set the gate delay line to the carrier-off region with the rotary knob. F2: <<Gate Length>>, and set the gate length as shown at the right.
		
13	Span frequency setting	: [Span], [2], [4], [MHz]
14	Center frequency setting	: [Frequency], [1], [9], [0], [6], [.] , [5], [5], [MHz]
15	Sweep time setting	: [Sweep Time], [4], [s], [Single]
	(A) Carrier-off leakage power value P (OFF)	
16	Multi Mkr setting	: [Shift], [Marker] (Multi Mkr), F2: <<Highest 10>>, F5: <<Marker List>> A carrier-off leakage power list (frequency and level of each) is displayed. At this time, if the message "Can not search" is displayed, press [Peak Search].
	★ Example of measurement result: -71.87 dBm	
	(B) Carrier-on leakage power value P(ON)	
17	Turn off the gate	: Press [Trig/Gate] until F1: <<Gate Sweep>> is displayed. Select Off with F1: <<Gate Sweep>>, then press [Single].
18	Marker setting	: [Peak Search] The power when the carrier is on is displayed.
	★ Example of measurement result: 1.86 dBm.	
	Carrier off/on power ratio: P (L)-P (O)	

Example 2 When Wide IF Video trigger used

- Set the detection mode to the Pos Peak mode.

(1) Measurement block diagram

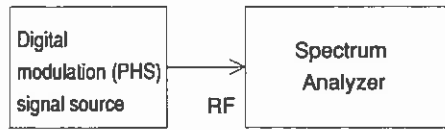

- Input signal frequency : 1.9 GHz
- Center frequency : 1906.55 MHz
- Span frequency width : 24 MHz
- RBW : 300 kHz
- VBW : 3 MHz
- Sweep time : 4 s

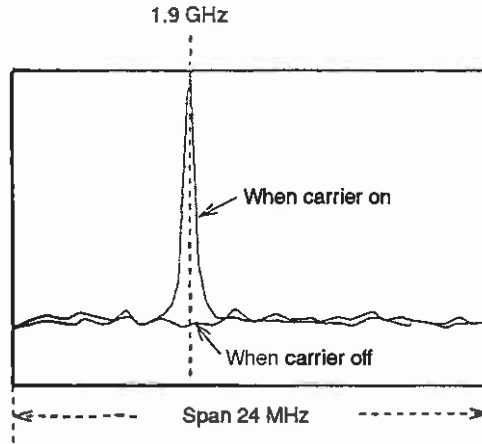

(2) Measurement procedure

Step	Procedure
1	Preset : [Preset], F1: <<Preset All>>
2	Couple mode setting : [BW], [More], F6: <<Couple independent>>
3	Reference level setting : [Amplitude], [2], [0], [dBm]
4	Center frequency setting : [Frequency], [1], [1], [9], [GHz]
5	RBW setting : [BW], F1: <<RBW Manual>>, [1], [MHz]
6	VBW setting : [BW], F2: <<VBW Manual>>, [1], [MHz]
7	Time span setting : [Time], F2: <<Time Span>>, [5], [msec]
8	Reference level setting : After 1 sweep, press [→RLV].
9	Trigger setting : Select Triggered with [Trig/Gate] and F1: <<Triggered>> and set to the level at which the trigger is to be applied by changing F1: <<Trigger Level>> to High, Middle, or Low. (Use Low as much as possible.)
10	RBW setting : [BW], F1: <<RBW Manual>>, [3], [0], [0], [kHz]
11	VBW setting : [BW], F2: <<VBW Manual>>, [3], [MHz]

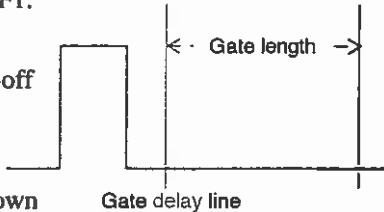
Step	Procedure
12	<p>Gate setting : Press [Trig/Gate] until F1: <<Gate Sweep>> is displayed. Select On with F1: <<Gate Sweep>>. Press F2: <<Gate Setup>>, F1: <<Gate Delay>> and set the gate delay line to the carrier-off region with the rotary knob. Press F2: <<Gate Length>> and set the gate length as shown in the figure at the right with the rotary knob.</p> 
13	Span frequency setting : [Span], [2], [4], [MHz]
14	Center frequency setting : [Frequency], [1], [9], [0], [6], [.] , [5], [5], [MHz]
15	Sweep time setting : [Sweep Time], [4], [s]
	(A) Carrier-off leakage power value P (L)
16	Marker Peak : [Peak Search]
★	Example of measurement result: -71.87 dBm
	(B) Carrier-on leakage power value P(ON)
17	Turn off the gate : Press [Trig/Gate] until F1: <<Gate Sweep>> is displayed. Select Off with F1: <<Gate Sweep>>, then press [Single].
18	Marker setting : [Peak Search] The power when the carrier is on is displayed.
★	Example of measurement result: 1.86 dBm
	Carrier off/on power ratio: P (L)-P (O)

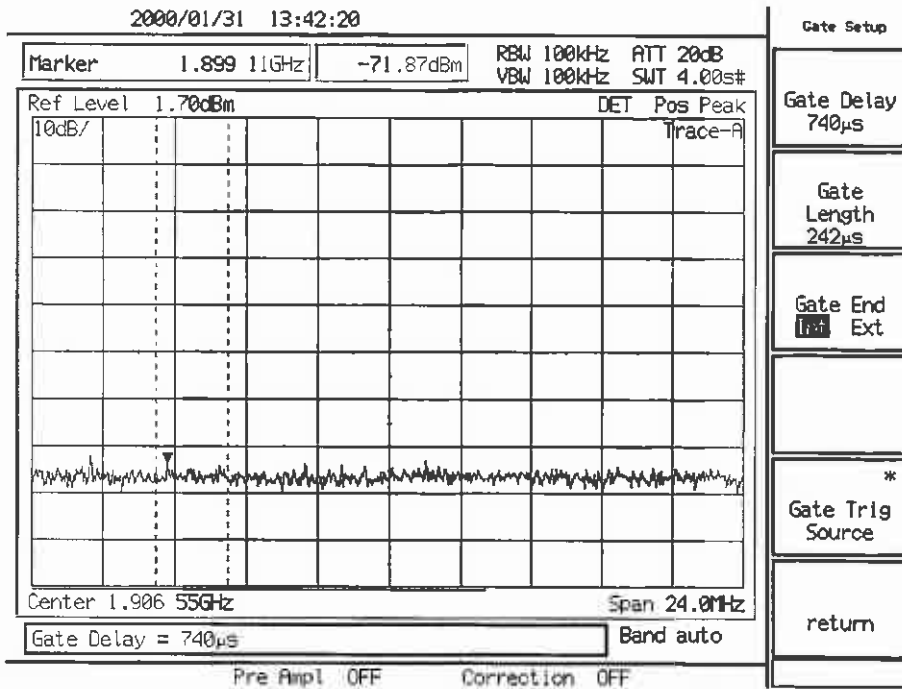

Example of Carrier-Off Leakage Power P (L) Measurement

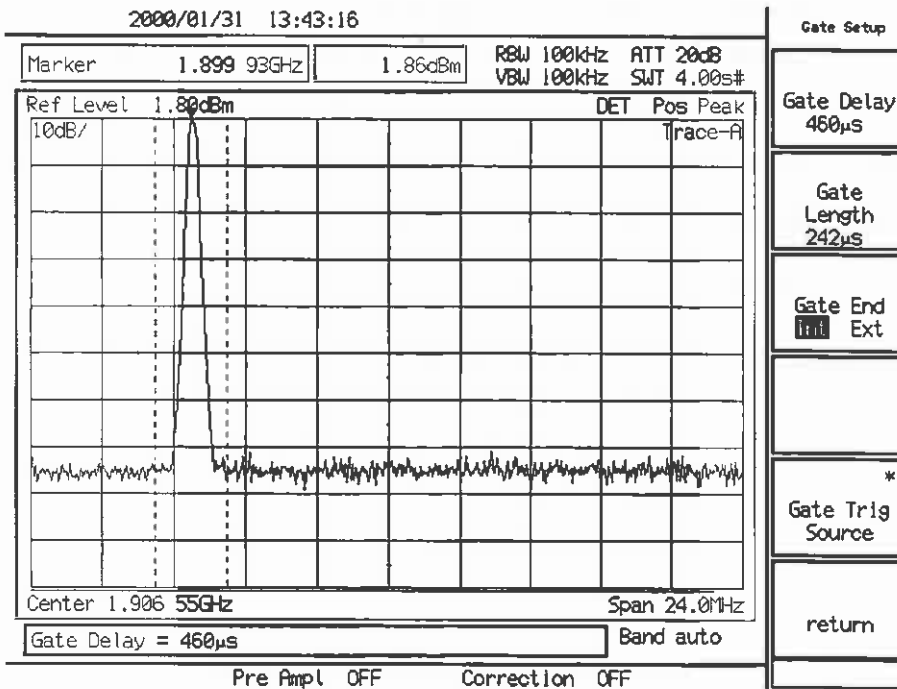

Example of Carrier-On Leakage Power P (O) Measurement

Example of Measurement of Adjacent Channel Leakage Power

(1) Measurement block diagram

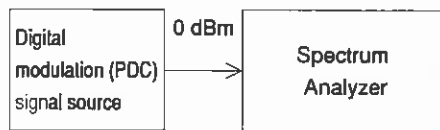

- Center frequency : 900 MHz
- Span frequency width : 250 kHz
- RBW : 1 kHz
- VBW : 3 kHz
- Sweep time : 10 s

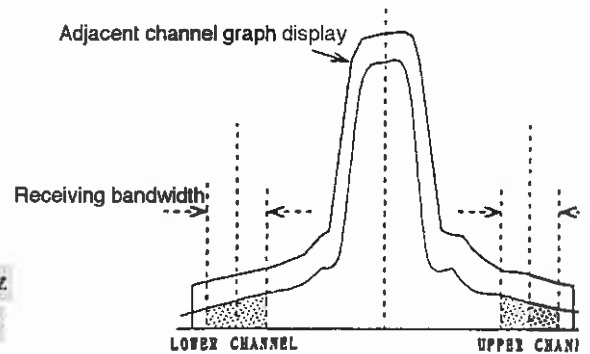

(2) Measurement procedure

Step	Procedure
1	Preset : [Preset], F1: <<Preset All>>
2	Span frequency setting : [Span], [2], [5], [0], [kHz]
3	Center frequency setting : [Frequency], [9], [0], [0], [MHz]
4	RBW setting : [BW], F1: <<RBW Manual>>, [1], [kHz]
5	VBW setting : [BW], F2: <<VBW Manual>>, [3], [kHz]
6	Reference level setting : [Amplitude], [0], [dB]
7	Sweep time setting : [Sweep Time], [1], [0], [s]
8	ATT setting : Press [ATTEN], then set to the minimum value with the rotary knob.
9	Single sweep : [Single]
10	Measurement preparation : Press [Measure] until F2: <<Adj Ch Pwr>> is displayed, then press F2: <<Adj Pwr Measure>>.
11	Adjacent channel setting : F2: <<Ch Sepa-1>>, [5], [0], [kHz] F3: <<Ch Sepa-2>>, [1], [0], [0], [kHz] (*1)
12	Receiving bandwidth setting: F4: <<Ch BW>>, [2], [1], [kHz]

Step	Procedure
13	Method of calculation : Select Total Pwr or Ref Level or Inband with F5: <<Setup>>, F1 to F3 <<Method>>. (*2)
14	Graph display : On page 2 of <<set up>> when On is selected with F1: <<ACP Graph>>, graph display is performed.
15	Channel display method : When On is selected with F2: <<Ch Center Line>>, a line which indicates the adjacent frequency center frequency is displayed. When On is selected with F3: <<Ch BW Line>>, a line which indicates the adjacent channel bandwidth is displayed. When On is selected with F4: <<Inband BW Line>>, a line which indicates the Inband is displayed.
16	Measurement channel setting: [More], F1: <<Both Channel>>, F6: <<return>>
17	Measurement: F1 : <<Execute>> The measured value is displayed at the top left-hand corner of the screen.

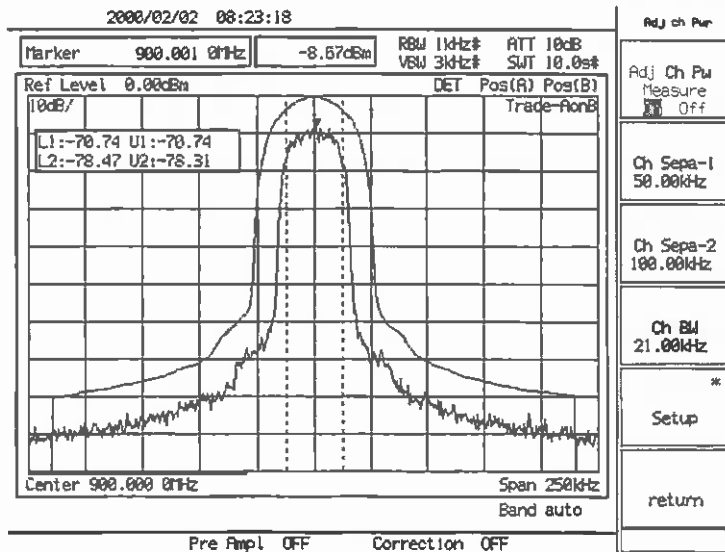

Example of Adjacent Channel Leakage Power Measurement

Note:

- *1 Reference channel center-In total power method and Inband method, this is defined as the center of zone marker.
In Reference level method, the display's center is defined as reference channel center.
- *2 The reference value for each of the calculation method is defined as below.
Total Power method: The total power of entire waveform displayed.
Ref Level method: The reference level value of the display.
Inband method: The total power in the "Inband" defined with marker zone center as reference channel center.

Example of Memory Card Use

If the measurement screen is stored in a memory card, the same measurement can be performed later by recalling the stored measurement screen. This eliminates troublesome setting of the measurement parameters each time and prevents setting errors. It is designed especially to shorten the measurement time when the setting operation is complex.

Storage method (Assume that the DATA number is 20.)

- 1) Measurement screen single sweep: [Single]
- 2) Press [Shift], [Recall] (save), [More] until F1: <<Save to Mem Card>> is displayed, then press F1: <<Save to Mem Card>>, [2], [0], [Enter].

This completes saving of the screen parameters to Memory Card 20.

Recalling method (Assume that the DATA number is 20.)

- 1) Stored screen display : Press [More] until [Recall], F1: <<Recall from Mem Card>> is displayed, then press F1: <<Recall from Mem Card>>, [2], [0], [Enter].
- 2) Continuous sweep : [Continuous]

Example of Time Template Creation (PHS Transmit Signal)

1) Burst wave screen setting (time domain)

Time span : 1 ms
Trigger : -200 us
RBW : 1 MHz
VBW : 1 MHz
RLV : +15 dBm

2) Template data overwrite method

- Template scale number setting (No. 1 here):
Press [Time], [Measure] until F5: <<Time Template>> is displayed, then press F1: <<Time Template>>, F5: <<Setup Temp Table>>, F1: <<Select Temp Table>>, F1: <<Temp-1>>, F6: <<return>>.
- Data write preparation: Select Relative with F2: <<Level>>.
F3: <<Make Up Temp Table>>, [More], F2: <<Select Line>>, F1: <<Limit1 Upper>>, F6: <<return>>, [More] (Here, Limit1 Upper is specified.)
- Data write: Sequentially write the coordinates (time, level) of the template to be created in ascending order of time value.
Write data by alternately repeating time setting and level setting.
 - * Time setting (example: -200 us) : [+/-], [2], [0], [0], [us]
 - * Level setting (example: -65 dB) : [+/-], [6], [5], [dB]
- Limit1 Lower write: Press [More], F2: <<Select Line>>, F2: <<Limit 1 Lower>>, F6: <<return>>, [More], then write the template coordinate data.

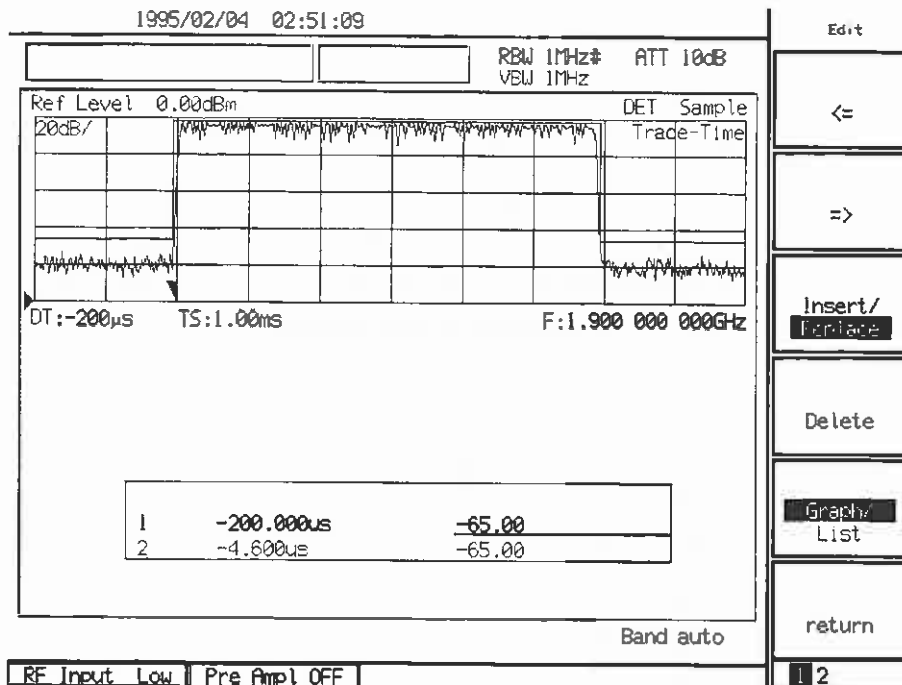

TEMPLATE Creation Screen (Graph)

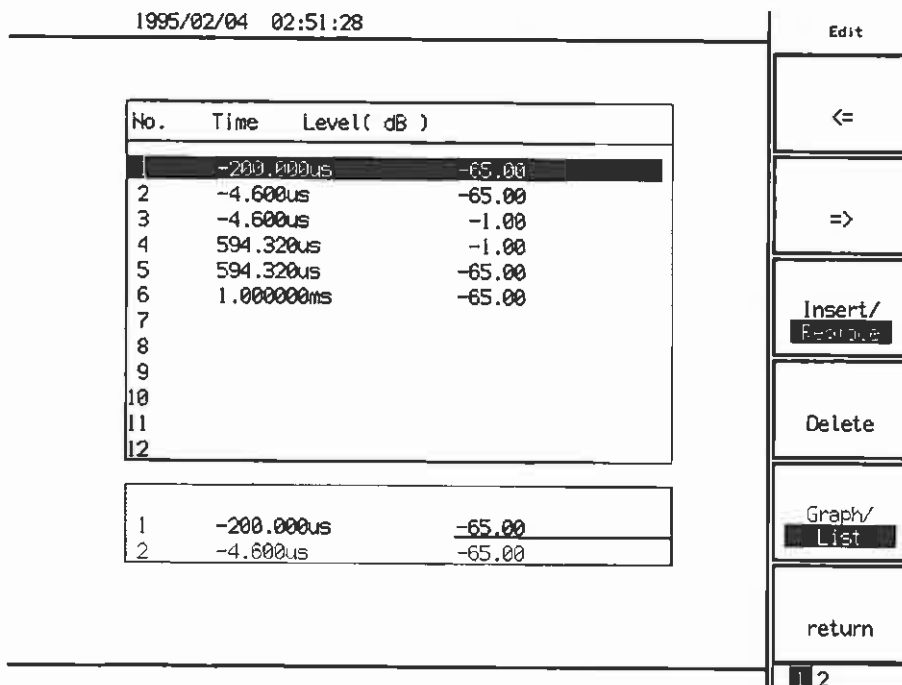

TEMPLATE Creation Screen (List)

3) Template coordinates (PHS: RCR STD-28)

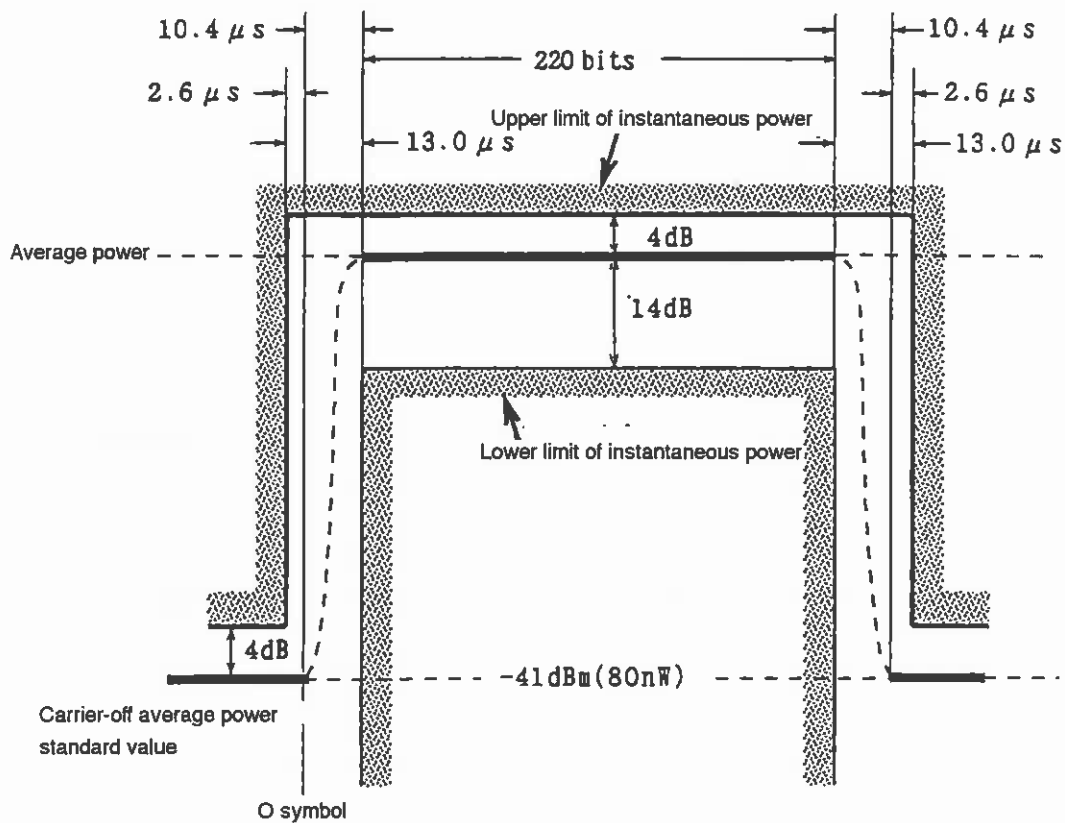

Coordinate reference line (Trigger position → left end of screen: -200 μs)

When average power in burst of input signal is 19 dBm and SPA REF LEVEL is 24 dBm

• Limit1 Upper coordinates

(1)	-200 μs ,	-65 dB
(2)	-4.6 μs ,	-65 dB
(3)	-4.6 μs ,	-1 dB
(4)	594.32 μs ,	-1 dB
(5)	594.32 μs ,	-65 dB
(6)	1 ms,	-65 dB

• Limit1 Lower coordinates

(1)	8.40 μs ,	-100 dB
(2)	8.40 μs ,	-19 dB
(3)	581.32 μs ,	-19 dB
(4)	581.32 μs ,	-100 dB

4) Template coordinates (PDC-RCR STD-27B)

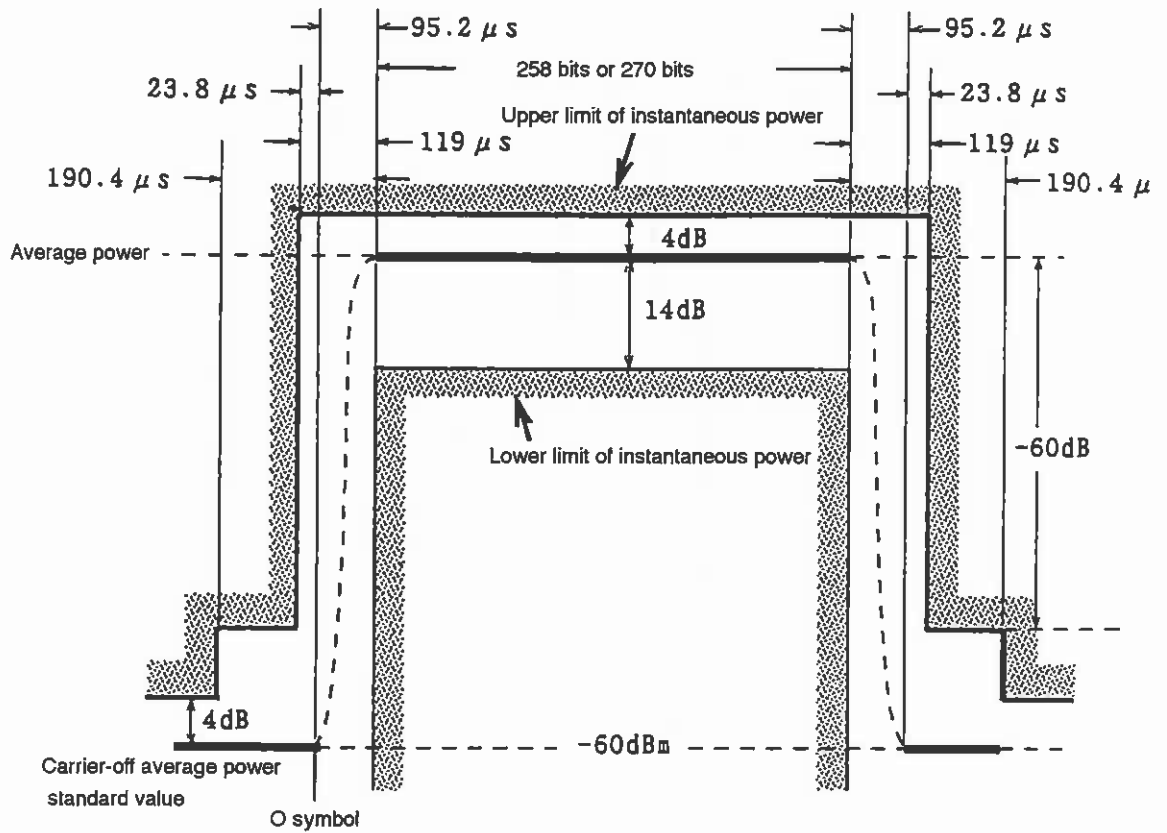

Coordinates standard line (Trigger position → screen left end: -1 ms)

When average power in burst of input signal is 10 dBm and SPA REF LEVEL is 15 dBm

• Limit1 Upper coordinates

(1)	-1.7 ms,	-71 dB
(2)	-114.21 μs,	-71 dB
(3)	-114.21 μs,	-65 dB
(4)	42.81 μs,	-65 dB
(5)	42.81 μs,	-1 dB
(6)	6.6238 ms,	-1 dB
(7)	6.6238 ms,	-65 dB
(8)	6.6952 ms,	-65 dB
(9)	6.6952 ms,	-71 dB
(10)	8.3 ms,	-71 dB

• Limit1 Lower coordinates

(1)	76.19 μs,	-100 dB
(2)	76.19 μs,	-19 dB
(3)	6.5048 ms,	-19 dB
(4)	6.5048 ms,	-100 dB

5) Template coordinates (GSM, DCS1800)

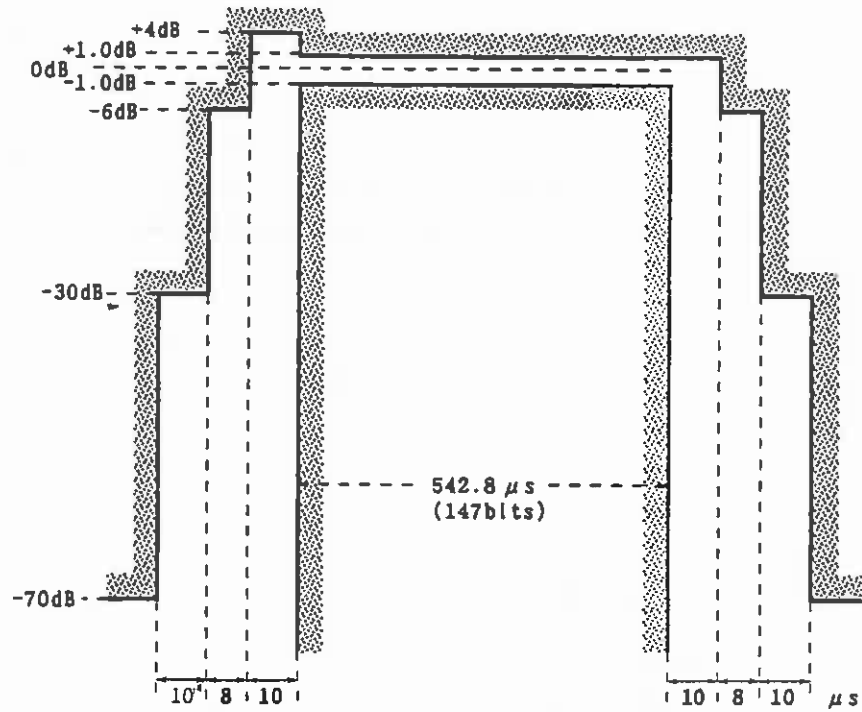

Coordinates standard line (Trigger position → left end of screen: -75.0 μs)

• Limit 1 Upper coordinates

(1)	-75.0 μs,	-75 dB
(2)	-25.0 μs,	-75 dB
(3)	-25.0 μs,	-35 dB
(4)	-15.0 μs,	-35 dB
(5)	-15.0 μs,	-11 dB
(6)	-7.0 μs,	-11 dB
(7)	-7.0 μs,	-1 dB
(8)	3.0 μs,	-1 dB
(9)	3.0 μs,	-4 dB
(10)	555.8 μs,	-4 dB
(11)	555.8 μs,	-11 dB
(12)	563.8 μs,	-11 dB
(13)	563.8 μs,	-35 dB
(14)	573.8 μs,	-35 dB
(15)	573.8 μs,	-75 dB
(16)	625.0 μs,	-75 dB

• Limit1 Lower coordinates

(1)	3.0 μs,	-100 dB
(2)	3.0 μs,	-6 dB
(3)	545.8 μs,	-6 dB
(4)	545.8 μs,	-100 dB

MASK Creation in Frequency Domain Mode

1) Mask data write method

- Template scale number setting (Here it is 1.):
Press [A, B] and F1: <<Trace A>> and press [Measure] until F3: <<Mask>> is displayed, then press F3: <<Mask>>, F5: <<Setup Mask Table>>, F1: <<Select Mask Table>>, F1: <<Mask-1>>, F6: <<return>>.
- Data write preparation: Select Relative with F2: <<Level>>.
F3: <<Make Up Mask Table>>, [More], F2: <<Select Line>>, F1: <<Limit1 Upper>>, F6: <<return>>, [More] (Here, Limit1 Upper is specified.)
- Data write: Write the coordinates (frequency, level) of the template to be created in ascending order of time value.
Write the data by alternately repeating time setting and level setting.
 - * Frequency setting (example: 800 MHz): [8], [0], [0], [MHz]
 - * Level setting (example: -60 dB): [+/-], [6], [0], [dB]
- Limit1 Lower write: Press [More], F2: <<Select Line>>, F2: <<Limit1 Lower>>, F6: <<return>>, [More], then write the mask data coordinates data.

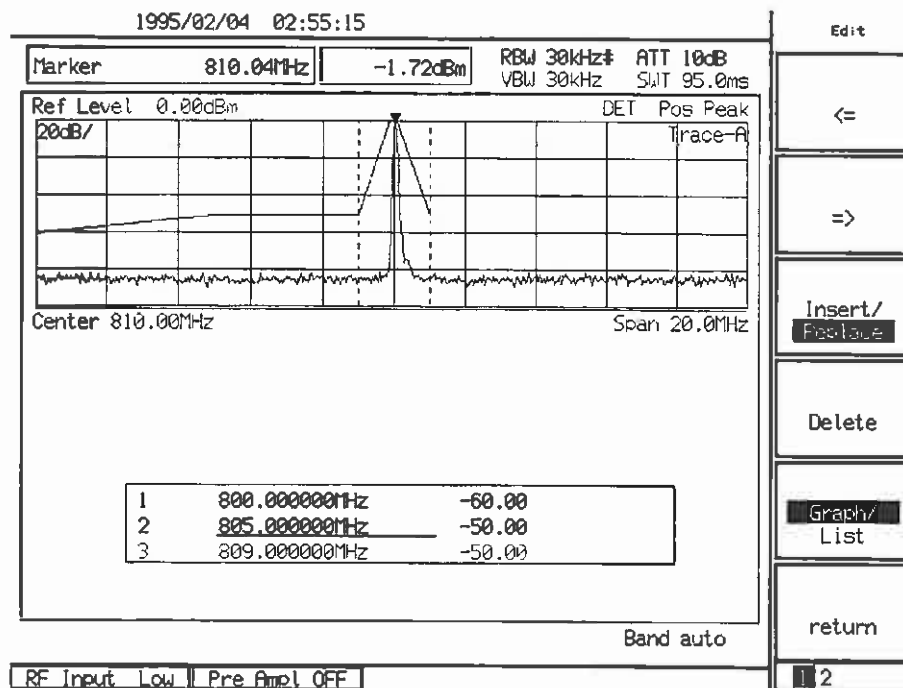

MASK Creation Screen (Graph)

1995/02/04 02:51:28

No.	Time	Level(dB)
1	-200.000us	-65.00
2	-4.600us	-65.00
3	-4.600us	-1.00
4	594.320us	-1.00
5	594.320us	-65.00
6	1.00000ms	-65.00
7		
8		
9		
10		
11		
12		

1	-200.000us	-65.00
2	-4.600us	-65.00

Edit

<=

=>

Insert/
Replace

Delete

Graph/
List

return

2

MASK Creation Screen (List)

Section 13 Measurement of Field Strength

This section gives the explanation and cautions on the operation procedure of field strength measurement using MS2681A/MS2683A/MS2687A/MS2687B Spectrum Analyzer.

Field Strength Measurement	13-3
Direct Measurement of Field Strength Using a Designated Antenna	13-3
Method to Seek Field Strength by Calculation	13-5
User Antenna Factor Setting, Save/Local to /from a Memory Card	13-6
Save/Load of User antenna factor To/From a Memory Card	13-6
Caution: When Performing Field Strength Automatic Measurement	13-7

Field Strength Measurement

In field strength measurement, incoming wave is received and measured by connecting a measuring antenna and RF Input connector of a spectrum analyzer with a coaxial cable as in the illustration below.

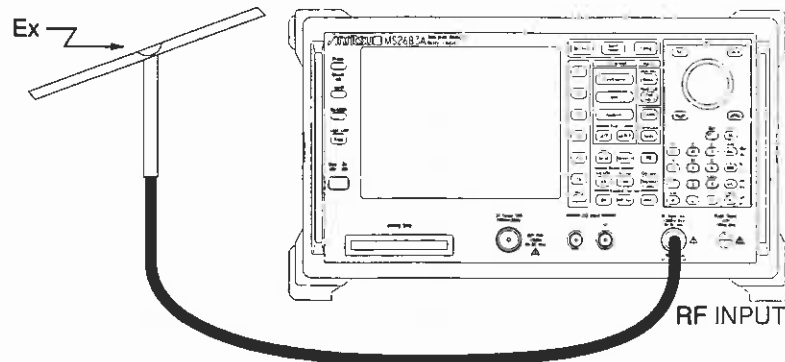

Direct Measurement of Field Strength Using a Designated Antenna

The system has a built-in antenna factor correction process for the purpose of measurements using antenna. By selecting an antenna to be used from the menu, field strength can be directly indicated.

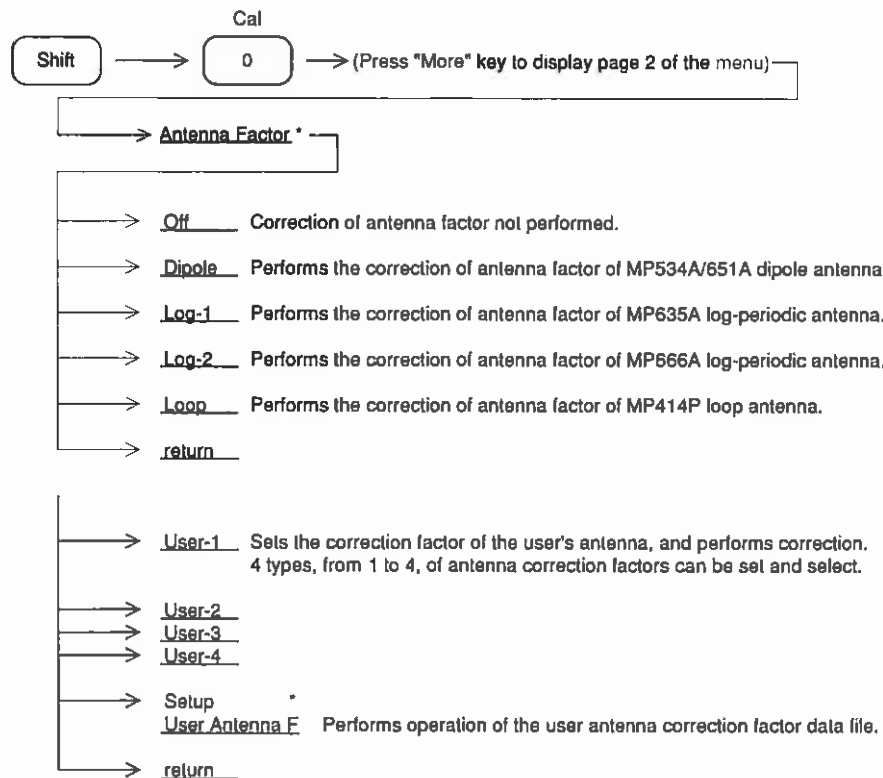

When an antenna to be used is selected, the indication unit of the levels is set to "dB μ V/m" automatically. Correction factors of some antennas are defined by open terminal. In that case, set the unit at "dB μ V (emf)" (open terminal).

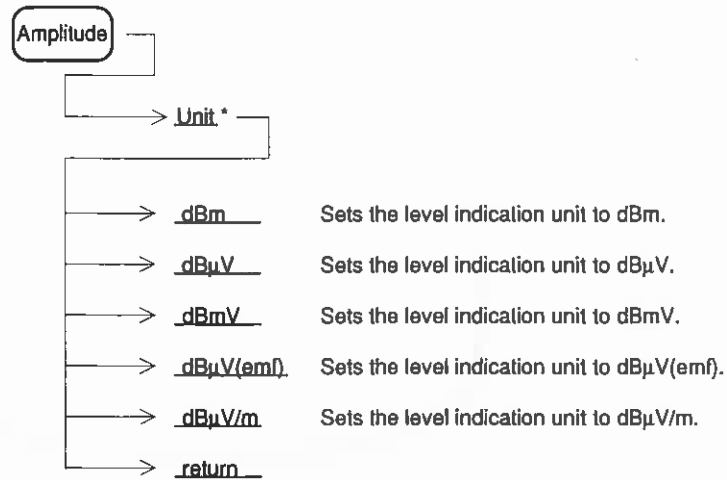

Method to Seek Field Strength by Calculation

Generally, field strength is given by ($E_x = P_x + K_0$).

P_x : measured value ($\text{dB}\mu\text{V}$)

K_0 : antenna calibration factor (dB) The factor for converting the measured voltage
{ $\text{dB}\mu\text{V}$ (final value)} into field strength ($\text{dB}\mu\text{V}/\text{m}$)

- a. Set the level indication unit to $\text{dB}\mu\text{V}$, and measure the received signal by $\text{dB}\mu\text{V}$.
- b. Refer the chart attached to the antenna for the value K_0 , and calculate the appropriate field strength.

Note:

In some antennas, the antenna calibration factor is defined by the following:

$$E_x = P_x - K_0$$

P_x : measured value ($\text{dB}\mu\text{V}$ (emf))

K_0 : antenna calibration factor (dB)

In this case, press [F6] function key to select UNIT $\text{dB}\mu\text{e}$, and measure the received signal by $\text{dB}\mu\text{V}$ (emf).

User Antenna Factor Setting, Save/Local to /from a Memory Card

Save/Load of User antenna factor To/From a Memory Card

The antenna correction factor data programmed from RS232C/GPIB can be saved in a memory card. The antenna correction factor data saved in the memory card can be reused by loading.

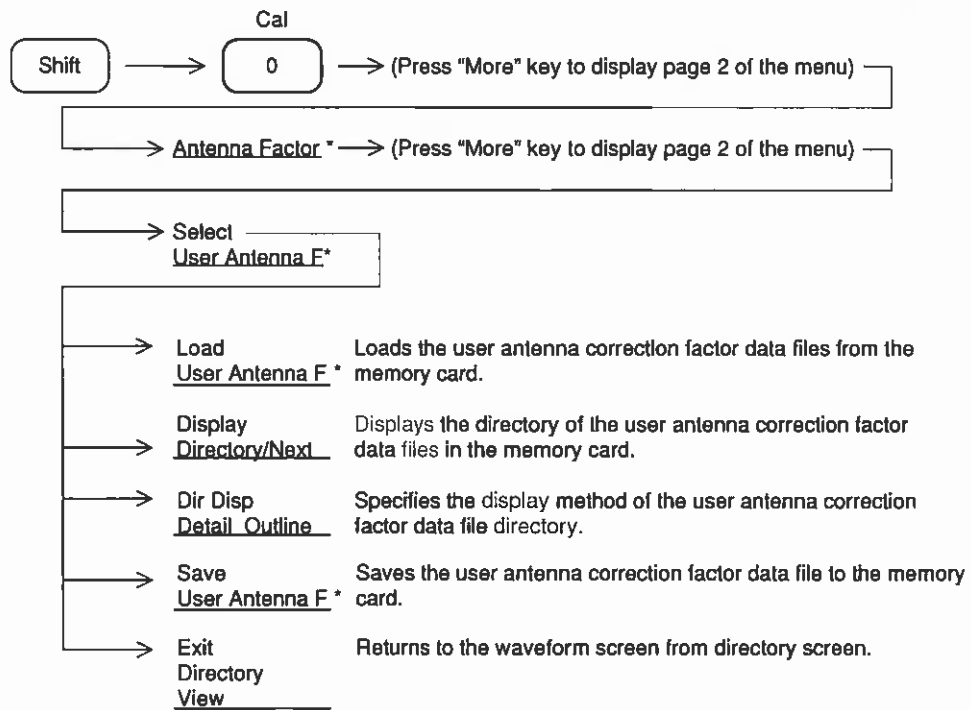

Caution: When Performing Field Strength Automatic Measurement

When automatically measuring field strength, it is done by RS232C or GPIB control. Since a personal computer is used in such a case, it is necessary to note the following;

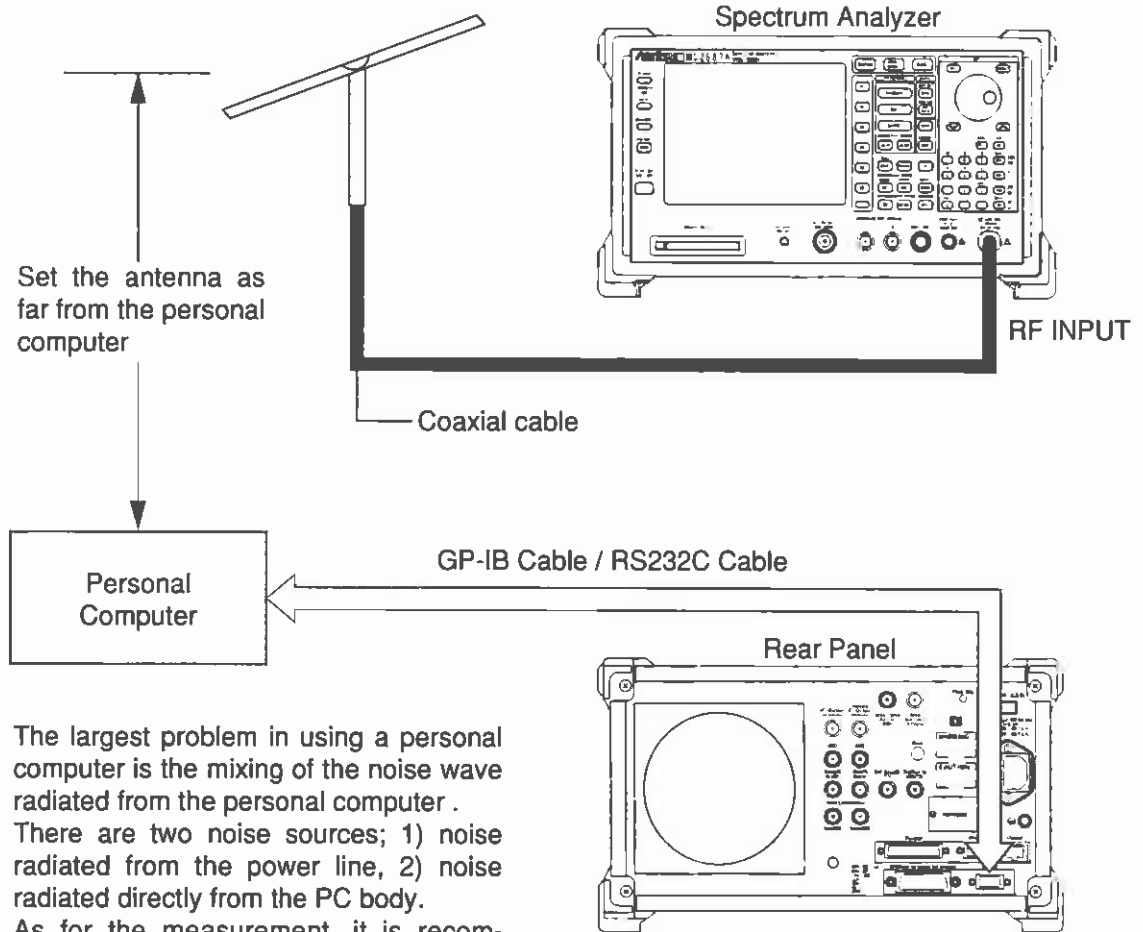

The largest problem in using a personal computer is the mixing of the noise wave radiated from the personal computer . There are two noise sources; 1) noise radiated from the power line, 2) noise radiated directly from the PC body. As for the measurement, it is recommended to set the antenna as far from the personal computer , Interface cable, and AC line or the like as possible. Also, utilizing the directivity of antenna, turn the antenna or place the other equipment so as to minimize the reception of the noise.

Caution: When Connecting With a Personal Computer

Section 14 External Mixer

This section describes the operation of the external mixer and measurement procedure using examples.

External Mixer Function	14-3
Function	14-3
Connecting the external mixer	14-4
Setting the band of the external mixer	14-5
Setting the external mixer	14-5
Setting the conversion loss of the external mixer	14-6
Identifying the signal-Signal ID	14-6

External Mixer Function

External mixer function is MS2687A/MS2687B dedicated function.

The frequency range of MS2687A/MS2687B extends up to 110 GHz by using optional external mixer.

Part number	Frequency range	Waveguide frange
MA2740A	18 to 26.5 GHz	MIL-F3922/68-001KM
MA2741A	26.5 to 40 GHz	MIL-F3922/68-001AM
MA2742A	33 to 50 GHz	MIL-F3922/67B-006
MA2743A	40 to 60 GHz	MIL-F3922/67B-007
MA2744A	50 to 75 GHz	MIL-F3922/67B-008
MA2745A	60 to 90 GHz	MIL-F3922/68B-009
MA2746A	75 to 110 GHz	MIL-F3922/68B-010

Function

To operate the external mixer, perform the following key operations.

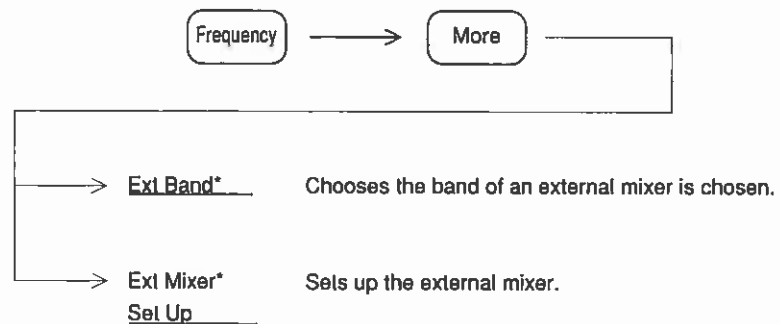

Connecting the external mixer

The below figure illustrates how to connect the external mixer to the MS2687A/MS2687B.

Step	Procedure
1	Fix the external mixer to the device under test.
2	Connect the optional coaxial cable J0322B to the 1st Local Output on the front panel.
3	Connect the coaxial cable to the IF/LO interface on the external mixer.

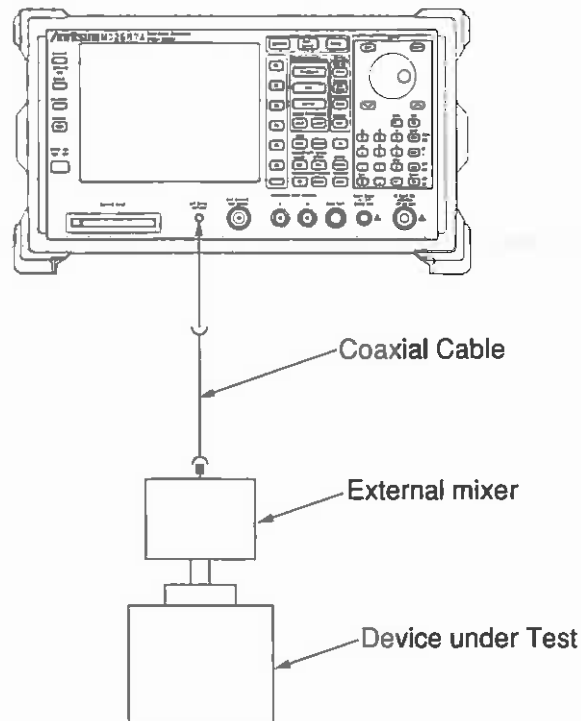

Note:

- 1 Use the low insertion loss cable among Local frequency range (4 to 7 GHz) and IF frequency (460.69 MHz) that is connected the external mixer.
- 2 Tighten the SMA connector by the regulation torque.
- 3 Don't lost the terminator for the 1st Local Output.

Setting the band of the external mixer

To set the band, perform the following key operation:



Select the band (K, A, Q, U, V, E, W) by the rotary knob and step key.

The table below shows band, frequency range and harmonic order of the external mixer.

Band	Frequency range	hormonic order (N)
K	18.0 to 26.5 GHz	4+/-
A	26.5 to 40.0 GHz	6+/-
Q	33.0 to 50.0 GHz	8+/-
U	40.0 to 60.0 GHz	9+/-
V	50.0 to 75.0 GHz	11+/-
E	60.0 to 90.0 GHz	13+/-
W	75.0 to 110.0 GHz	16+/-

The below equation shows the side band phase noise on the selected band.

$$\text{Sideband phase noise} = -95 \text{ dBc/Hz} + 20 \text{ Log N}$$

Setting the external mixer

To bias the external mixer, perform the following key operation:



Adjust the optimum biasing level so that level of the recieved signal on the screen become maximum by rotary knob ten key and step key.

Biasing range is -0 to +20 mA (0.1 mA resolution).

Note:

- 1 The frequency response of the external mixer depends on bias level. When changed the frequency in the same band, be sure to adjust the optimum biasing level.

Setting the conversion loss of the external mixer

To set the conversion loss of the external mixer, perform the following operations:

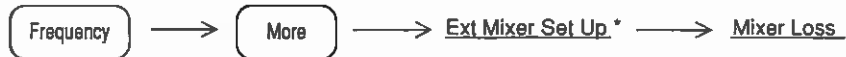

Set the conversion loss of the external mixer to measure correct level by rotary knob, ten key and step key.

Identifying the signal-Signal ID

Shall identify the signal on the screen in case of non preselecting external mixer. Because IF output of external mixer contains many mixer product by following equation.

$$\text{IF frequency} = \text{RF frequency} \pm \text{LO frequency} \times N$$

IF frequency of MS2687A is equal to 460.69 MHz.

N is harmonic order at mixer.

The signal inversed polarity (\pm) to Local signal is called "image response".

Also the signal multiplied local signal by incorrect harmonic order (N) is called "multiple response"

Signal ID function switch to polarity (\pm) to local signal alternately at each sweep.

Consequently, the correct signal on the screen does not change the position (frequency) alternately at each sweep.

Also false signal on the screen shift alternately the position (frequency) by more amount of IF frequency $\times 2$ at each sweep.

To switch to On signal ID function, perform the following key operations:



Note:

- 1 When received signal that is not specified, be sure to execute signal ID. Also after executed identifying the signal, shall switch to Off signal ID because the signal that is received by inverse polarity change the level by the frequency response of external mixer.

Section 15 MS2687A-21/MS2687B-21 Power Meter Function

This section explains the power meter function and the operation procedure of the MS2687A-21/MS2687B-21 (Option 21) for actual measurement.

MS2687A-21/MS2687B-21 Power Meter Function	15-3
Power Meter Function Overview	15-3
Connecting MS2687A/MS2687B to Power Sensor	15-4
Explanation of Measurement Screen	15-5
Explanation of Menu	15-6
Zero-point Calibration/zero-dBm Calibration (Zero/Cal)	15-7
Averaging Measured Results (Average)	15-8

MS2687A-21/MS2687B-21 Power Meter Function

The power meter function is supported only by the MS2687A/MS2687B with the MS2687A-21/MS2687B-21 (Option 21) mounted.

It is capable of high-accuracy power measurement in the frequency range from 100 kHz to 32 GHz.

The supporting power sensors for the power meter function are shown in the table below.

Model	Frequency range	Power measuring range	Max. input power	Input connector type
MA4601A	100 kHz to 5.5 GHz	-30 to +20 dBm (1 μ W to 100 mW)	300 mW (Average)	N
MA4701A	10 MHz to 18 GHz			APC-3.5
MA4703A	50 MHz to 26.5 GHz			
MA4705A	50 MHz to 32 GHz			

The nominal impedance is 50 Ω for all models.

Power Meter Function Overview

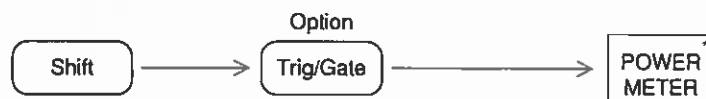

Connecting MS2687A/MS2687B to Power Sensor

CAUTION

Be sure to turn the MS2687A-21/MS2687B-21 power Off before connecting/removing the power sensor. Connecting/removing the power sensor to/from the power-on MS2687A-21 may damage the power sensor.

- [1] Connect the separately-sold sensor cord (J0370C/J0370E/J0370G) to Sensor Input on the MS2687A/MS2687B front panel.
- [2] Connect the sensor cord to the power sensor.
- [3] Turn the MS2687A/MS2687B power On.
- [4] Set the Cal Factor. Use the values indicated on the power sensor. Refer to the “Explanation of Menu” section for details on the Cal Factor settings.
- [5] Perform zero-point calibration/zero-dBm calibration (Zero/Cal). For details, refer to the “Zero-point Calibration/zero-dBm Calibration (Zero/Cal)” section.
- [6] After Zero/Cal is completed, connect the device to be measured to the power sensor.

The connection diagram is shown below:

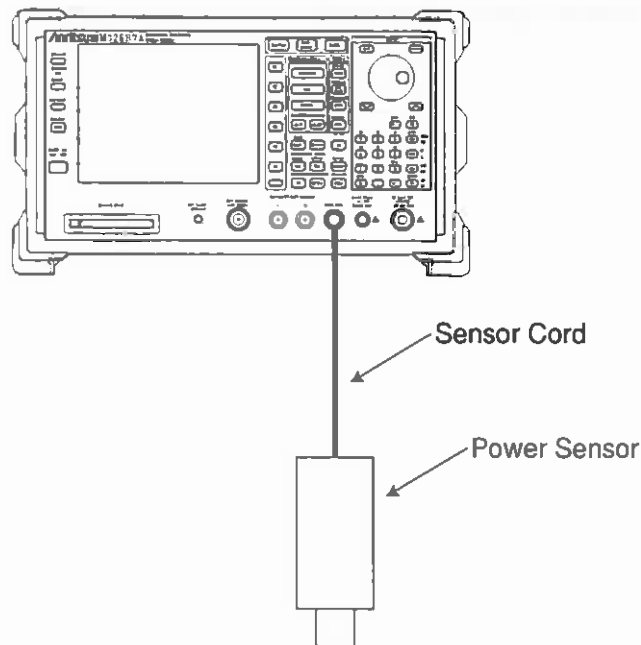

Explanation of Measurement Screen

This section explains the screen display for the power meter function.

Measurement screen

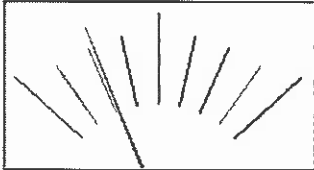
MS2687A		Option PowerMeter
POWER:	-0.05 dBm	PowerMeter On OFF
	-0.05 dB	Set Relative
	0.987 mW	Range Hold Auto
RANGE:	1 2 3 4 5	* Average
	Cal Factor: 0.08 dB	* Zero/Cal
	Ref Factor: 0.00 dB	return
	Offset : 0.00 dB	1 2
	Duty : 100.00 %	
	Average : Off	
Range = 3		

POWER

Displays the power measured with the power sensor in dBm/relative-level/W unit. The relative level value indicates the relative value of the measured value relative to the reference value (Ref Factor). Ref Factor can be set by pressing [Set Relative] (F2) in page 1/2, or [Reference Factor] (page 2/2) to set it manually.

RANGE

Displays the current measurement range.

Cal Factor, Ref Factor, Offset, Duty, Average

Displays the set value and setting status for each item. Refer to the "Explanation of Menu" section below for each item.

Explanation of Menu

This section explains the power meter function menu.

POWER METER On/Off (Page1/2 **F1**)

Switches the power meter function On/Off.

Set Relative (Page1/2 **F2**)

Sets the current measured value to the reference value of the relative level.

RANGE Hold/Auto (Page1/2 **F3**)

Selects whether to set the measurement range to a fixed value (Hold) or switch it automatically (Auto). Selecting Hold fixes the measurement range to the current one.

Average (Page1/2 **F4**)

Performs the averaging of the measured values. For details, refer to the “Averaging Measured Results (Average)” section, at the end of this Section 15.

Zero/Cal (Page1/2 **F5**)

Performs zero-point calibration/zero-dBm calibration (Zero/Cal). For details, refer to the “Zero-point Calibration/zero-dBm Calibration (Zero/Cal)” section below.

Cal Factor (Page2/2 **F1**)

Sets the Cal Factor of the power sensor. Use the cal. factor value indicated on the power sensor.

Reference Factor (Page2/2 **F2**)

Sets the reference value for the relative level, manually.

Offset (Page2/2 **F3**)

Sets the offset value for the measured value. When an attenuator is connected to the power sensor input for high-power measurement, entering the attenuation value of the attenuator as the offset value makes the measured value on the screen the actual value.

Duty (Page2/2 **F4**)

Sets the ratio of the displayed value on the screen to the measured value by the power sensor. Normally, set to 100%.

All Clear (Page2/2 **F5**)

Returns the setting values for Cal Factor, Reference Factor, Offset and Duty to their initial (default) values. The initial value for each parameter is shown below.

Cal Factor:	0.00 dB
Reference Factor:	0.00 dB
Offset:	0.00 dB
Duty:	100%

Zero-point Calibration/zero-dBm Calibration (Zero/Cal)

This section explains zero-point calibration/zero-dBm calibration (Zero/Cal). Set the Cal Factor before performing this Zero/Cal.

Zero **F2**

Performs zero-point calibration (calibration with no signal input). Press **F2** key without inputting any power to the power sensor.

Cal **F3**

Performs zero-dBm calibration (calibration with 0-dBm signal input). Connect the power sensor to the Cal Output on the front panel and then press **F3**.

Zero/Cal **F1**

Performs both zero-point calibration and zero-dBm calibration at the same time. Connect the power sensor to the Cal Output on the front panel and then press **F1**.

Connect to SENSOR/DUT **F5**

Select the SENSOR side.

Averaging Measured Results (Average)

This function performs the averaging of the power-meter measured result in the same way as p 5-18 "Averaging Function".

Average On/Off

Switches the averaging function On/Off.

Average Count

Sets the number of average processings.

Section 16 Measurement Software

The MS2681A/MS2683A/MS2687A/MS2687B Spectrum Analyzer can perform vector signal analysis with installing the measurement software, sold separately.

Measurement Software	16-3
Installing Measurement Software	16-4
Installing Core Module Software	16-6
Displaying Maintenance Parameter Information	16-8
Registering Installation Key	16-13

Measurement Software

Down-loading the measurement software (sold separately) to the MS2681A/MS2683A/MS2687A/MS2687B enables to execute the Signal Analysis.

Installing Measurement Software

Install the desired measurement software (sold separately) of the MS2681A/MS2683A/MS2687A/MS2687B in the Signal Analysis mode, as follows:

- | Step | Procedure |
|------|---|
| 1 | Insert a memory card on which the measurement software is saved into the memory card slot on the panel. |
| 2 | Press the (Config) key to display the Config screen. |
| 3 | Press (F4) (System Install) to display the Install System screen (shown below). |

MS2683A
 << Install System >>

Product Information
 Product Type : Spectrum Analyzer
 Product Model : MS2683A
 Serial Number : 00000
 Spectrum Analyzer Type : 8GHz

Install System		
System		Revision
MX268301A	W-CDMA	V 2.1
MX268302A	GSM	V 1.1
MX268302A	GSM	V 1.1

Memory Card		
System		Revision
MX268301A	W-CDMA	V 2.1
MX268302A	GSM	V 1.1

Core Module	
System	Revision
SPECTRUM ANALYZER	1.9
MAIN	1.9
IPL	1.3
DSP(CORE)	1.9

System install

- System Install
- Change Installed System
- Change Memory Card
- System Remove
- Core Module Install
- Back Screen

Step Up key : Previous Page / Step Down key : Next Page

- Press **(F2)** (Change Installed System) to make the Install System box active.
- Select the install destination for the new measurement system using the rotary knob.
- Press **(F3)** (Change Memory Card) to make the Memory Card box active.

Step	Procedure
7	Select the new measurement system using the rotary knob.
8	Press (F1) (System Install) to install the new system.
9	The confirmation window opens. Move the cursor to “Yes” using the rotary knob.
10	Press the (Set) Entry key to start installation.
11	After installation is completed, the new measurement system screen appears.

Installing Core Module Software

Install a new Core Module software on the MS2681A/MS2683A/MS2687A/MS2687B, as follows:

- | Step | Procedure |
|------|---|
| 1 | Insert a memory card on which a new Core Module software is saved into the memory card slot on the panel. |
| 2 | Press the (Config) key to display the Config screen. |
| 3 | Press (F4) (System Install) to display the Install System screen (shown below). |

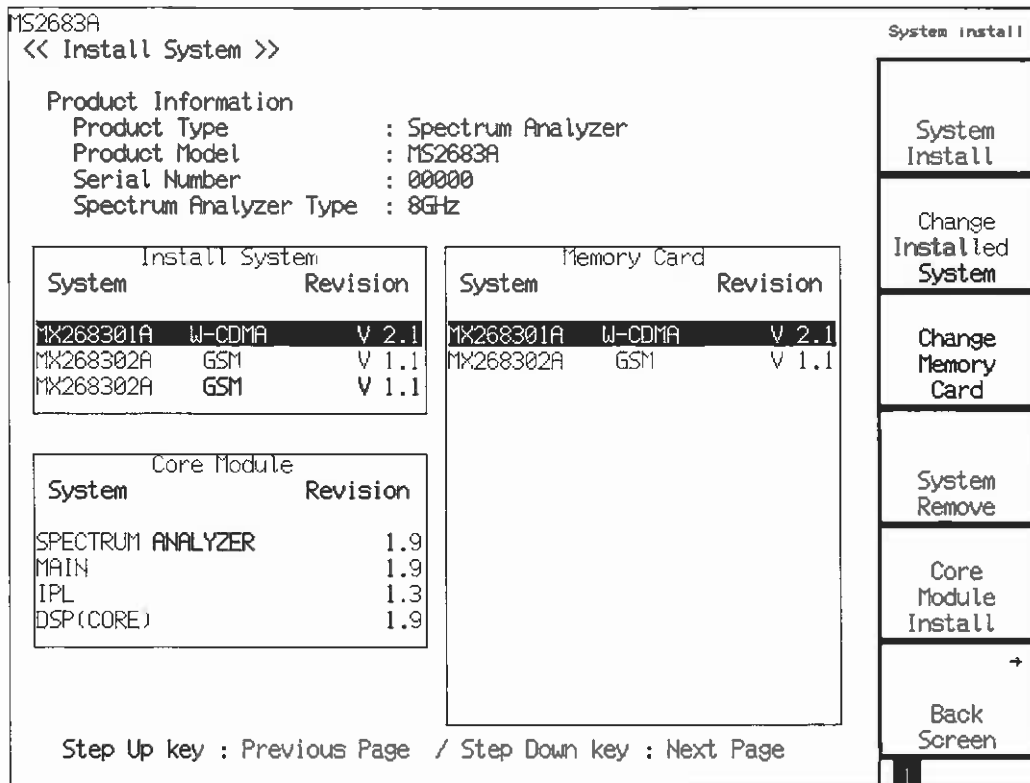

- Press **(F5)** (Core Module Install).
- The confirmation window opens. Move the cursor to "Yes" using the rotary knob.
- Press the **(Set)** Entry key to start installation.
- After installation is completed, turn the power off by following screen instruction.

Step	Procedure
8	Turn the power on, pressing the Preset key. Please continue pressing the Preset key until beep sounds. Beep sounds about 5 seconds later, after turning on the power switch.

Displaying Maintenance Parameter Information

Display the maintenance parameter information for the MS2681A/MS2683A/MS2687A/MS2687B, as follows:

Maintenance Parameter screen

Step	Procedure
1	Press the Config key to display the Config screen.
2	Press F2 (Maintenance Parameter) to display the Maintenance Parameter screen (shown below).

MS2683A		Maintenance
<< Maintenance Parameter >>		→
Product		Option
Type	: Spectrum Analyzer	→
Model	: MS2683A	Installed Software
Serial Number	: 00000	→
Spectrum Analyzer Type	: 8GHz	Installation Permission
Live Time Counter	: 62410 minutes	
Mechanical Switch		→
Switch 1	: 22497	Back Screen
Switch 2	: 12976	
Switch 3	: 21498	
Switch 4	: 11039	
Switch 5	: 5876	
High Power Input	: 792	
Low Power Input	: 12391	
Spa / Tx Tester	: 15996	
Power Meter	: 4408	

The following information is displayed on the Maintenance Parameter screen:

1. Product information
 - a. Type Product name
 - b. Model Model number
 - c. Serial Number
 - d. Spectrum Analyzer Type Type of the spectrum analyzer installed

2. Live Timer Counter information
 - a. Elapsed power-on time (in unit of minutes)

3. Mechanical Switch information
 - a. Switch 1 Number of switchings for ATT 2-dB
 - b. Switch 2 Number of switchings for ATT 4-dB
 - c. Switch 3 Number of switchings for ATT 8-dB
 - d. Switch 4 Number of switchings for ATT 16-dB
 - e. Switch 5 Number of switchings for ATT 32-dB
 - f. Spa/Signal Analysis Number of switchings between Spectrum analyzer and Measurement system

Option screen

Step	Procedure
------	-----------

- 1 Press **(F1)** (Option) to display the Option screen (shown below).

MS2683A
Maintenance

<< Option >>

Product Information
 Product Type : Spectrum Analyzer
 Product Model : MS2683A
 Serial Number : 00000

Option

001 Off : Precision Frequency Reference Oscillator
 002 Off : Narrow Bandwidth
 003 On : Extension of Preselector Lower Limit to 1.6GHz
 008 On : Pre-amplifier
 009 Off : Ethernet Interface
 046 Off : Auto Power Recovery
 047 Off : Rack Mount [IEC]
 048 Off : Rack Mount [JIS]
 040 On : ***
 041 On : ***
 100 Off : High Power ATT
 018 On : ***
 004 On : Digital RBW

Step Up key : Previous Page / Step Down key : Next Page

→

Back
Screen

The following information is displayed on the Option screen:

1. Product information
 - a. Type Product name
 - b. Model Model number
 - c. Serial Number
2. Option information
 - a. Option No.
 - b. Option status — On/Off
 - c. Option name

Installed Software screen

Step	Procedure
------	-----------

- 1 Press **F2** (Installed software) to display the Installed Software screen (shown below).

MS2683A Maintenance

<< Installed Software >>

Product

Type	:	Spectrum Analyzer	
Model	:	MS2683A	
Serial Number	:	00000	
Spectrum Analyzer Type	:	8GHz	

Software Revision

Spectrum Analyzer	:	1.9	
Main	:	1.9	
IPL	:	1.3	
DSP Core	:	1.9	

Installed System-1	:	MX268301A	W-CDMA	V 2.1
Installed System-2	:	MX268302A	GSM	V 1.1
Installed System-3	:	MX268302A	GSM	V 1.1

→

Back
Screen

The following information is displayed on the Installed Software screen:

1. Product information
 - a. Type Product name
 - b. Model Model number
 - c. Serial Number
 - d. Spectrum Analyzer Type The type of the spectrum analyzer installed

2. Software Revision information
 - a. Spectrum Analyzer Revision of the spectrum analyzer software
 - b. Main Revision of the Main software
 - c. IPL Revision of the IPL software
 - d. DSP Core Revision of the DSP Core Module software
 - e. Installed System-1 Revision of the software for installed system-1
 - f. Installed System-2 Revision of the software for installed system-2
 - g. Installed System-3 Revision of the software for installed system-3

Registering Installation Key

To install a new measurement software on the MS2681A/MS2683A/MS2687A/MS2687B, an installation key for the system must be registered. Register the install key, as follows:

Step	Procedure
1	Insert a memory card on which the installation key is saved into the slot.
2	Press the Config key to display the Config screen.
3	Press F2 (Maintenance Parameter) to display the Maintenance Parameter screen.
4	Press F3 (Installation Permission) to display the Installation Permission screen (shown below).

MS2683A
 << Installation Permission >>

Product Information
 Product Type : Spectrum Analyzer
 Product Model : MS2683A
 Serial Number : 00000
 Spectrum Analyzer Type : 8GHz

The System which is possible to install	
MX268301A	W-CDMA
MX268302A	GSM

Maintenance

Save Base Cal

System Permit

Back Screen

- Press **F2** (System Permit).
- The new measurement software is added to the Permission table.

Step	Procedure
7	Press F1 (Save Base Cal).

Note:

Step 5 above registers the installation key in the table. However, it is not registered in the internal memory until you perform Step 7. The installation key becomes valid after being registered in the internal memory.

Appendix A Soft-Key Menu

In this section, soft-key menu functions and its hierarchical system are described using a tree.

Soft-key Menu List	A-4
Spectrum mode Menu Tree	A-6
Config mode Menu Tree	A-30

In this section, soft-key menu functions and its hierarchical system are described using a tree. Matters to be noted about the tree are shown below.

- (1) Panel Key indicates a hard key on the front panel.
- (2) Top menus are the menus at the top level which are displayed on the screen when the panel key is pressed. Lower menus indicate other menus below the top menus.
- (3) When a soft key with an appended asterisk (*) is pressed in these menus, the menu moves to the lower menu indicated by the arrow symbol (->). However, if any not-supported-function soft key in an Option is pressed, an error message appears.
- (4) When the Return key is pressed at a lower menu, the next-higher menu returns.
- (5) Menus with more than six items are split into several pages.
- (6) The menu page construction and currently-displayed page are indicated in the lower part of the menu. To move to the next page, press the [More] key.
- (7) Panel keys and soft keys prefixed by a sharp symbol (#) at the left of the menu frame, give an outline explanation of the function.

Soft-key Menu List

Menu	Menu Tree (page/24)	Menu	Menu Tree (page/24)
A) A/B,A/BG	17	E) Expand	18
A/Time	18	F) Freq Count	9
ACP Freq	10	Frequency	1
ACP Method	10	Frequency Band	2
Adj ch Pwr	10	G) Gate	19
Amplitude	3	Gate Setup	19
Antenna F	23	GPIB Config 2/2	
Attenuator	5	Graph Setup	10
Avg Count	16	H) Hold Count	16
Average	20	I) Impedance	3
B) BMP File	21	Interface Config	Config 2/2
Burst Pwr	13	Item	14
BMP File	21	L) Lin Scale	3
BW	4	Line	11 , 12
BW BW Mode	4	Load/Save	11 , 12
BW Noise	4	Log Scale	3
BW Ratio	4	Lvl Offset	3
C) C/N Meas	9	M) Manual Set	6
Channel Power Measure	9	Marker	6
Cal	23	Marker->	6 , 7
Change Clr	22	Mask Meas	11
Ch Power	9	Measure	9 , 10
Copy Cont	21 , Config 2/2	Mkr Func	6
Copy from	22	Mkr List	6
Correction	3	Move Mask	11
Count Setup	9	Move Temp	12
CSV Setup	11 , 12 , 23	Multi Marker	6
D) Define Clr	22	N) Noise Meas	9
Detection	16 , 18	O) OBW Setup	10
Dip	7	Occ BW	10
Disp Line	6	Option	20
Display	Config 1/2		
Disp Pos	9		

Menu	Menu Tree (page/24)	Menu	Menu Tree (page/24)
P) Parameter	20	W) Wide IF	19
Peak Search	7	Y) Y-Out	23
Power On Config	1/2	Z) Zero/Cal	20
Pre Ampl	3	Zone Width	6
Preset	24		
Preslctr	23		
Printer	21		
Q)			
R) RBW	4		
Recall	14		
Ref Line	16		
Ref Step	3		
RS232C Config	2/2		
S) Save	15		
Save Media	21		
Scroll Step	2		
Select	3 , 11 , 12		
Setting Config	1/2		
Setup	3 , 23		
Source	19		
Span	2		
Storage	16 , 18		
Sweep Time	5		
Swp Contl	17 , 18		
System	24		
T) Template	12		
Threshold	7		
Title Config	1/2		
Trace A,B	16		
Trace Calc	16		
Trace Move	16		
Trace Time	18		
Trig Ext	19		
Trig Video	19		
Trigger	19		
U) Units	3		
V) VBW	4		

Spectrum mode Menu Tree

Menu Tree (1 /24)

Panel Key ——— Top menu ——— Lower menus ———

Frequency
Center Freq
Start Freq
Stop Freq
Pre-selector Auto Tune
#1 Auto Tune
#2 CF Step Size
1

- Set items related to frequency, including the center frequency, start/stop frequency, peak->CF, auto synchronization, and frequency scroll step size, etc.

#1 Detects peak point in pre-specified (in BG range) span and automatically tunes the peak signal to the specified span.

#2 Sets frequency step size for changing center frequency.

#3 When Option 03 is attached, displayed here.

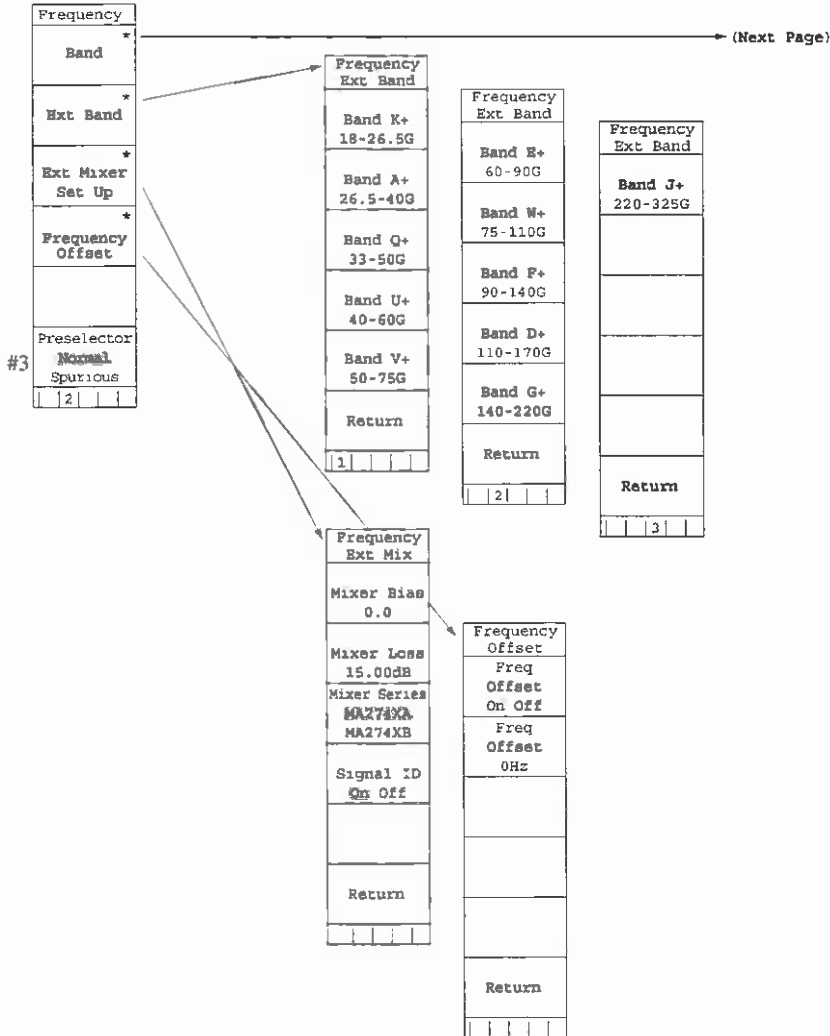

Menu Tree (2/24)

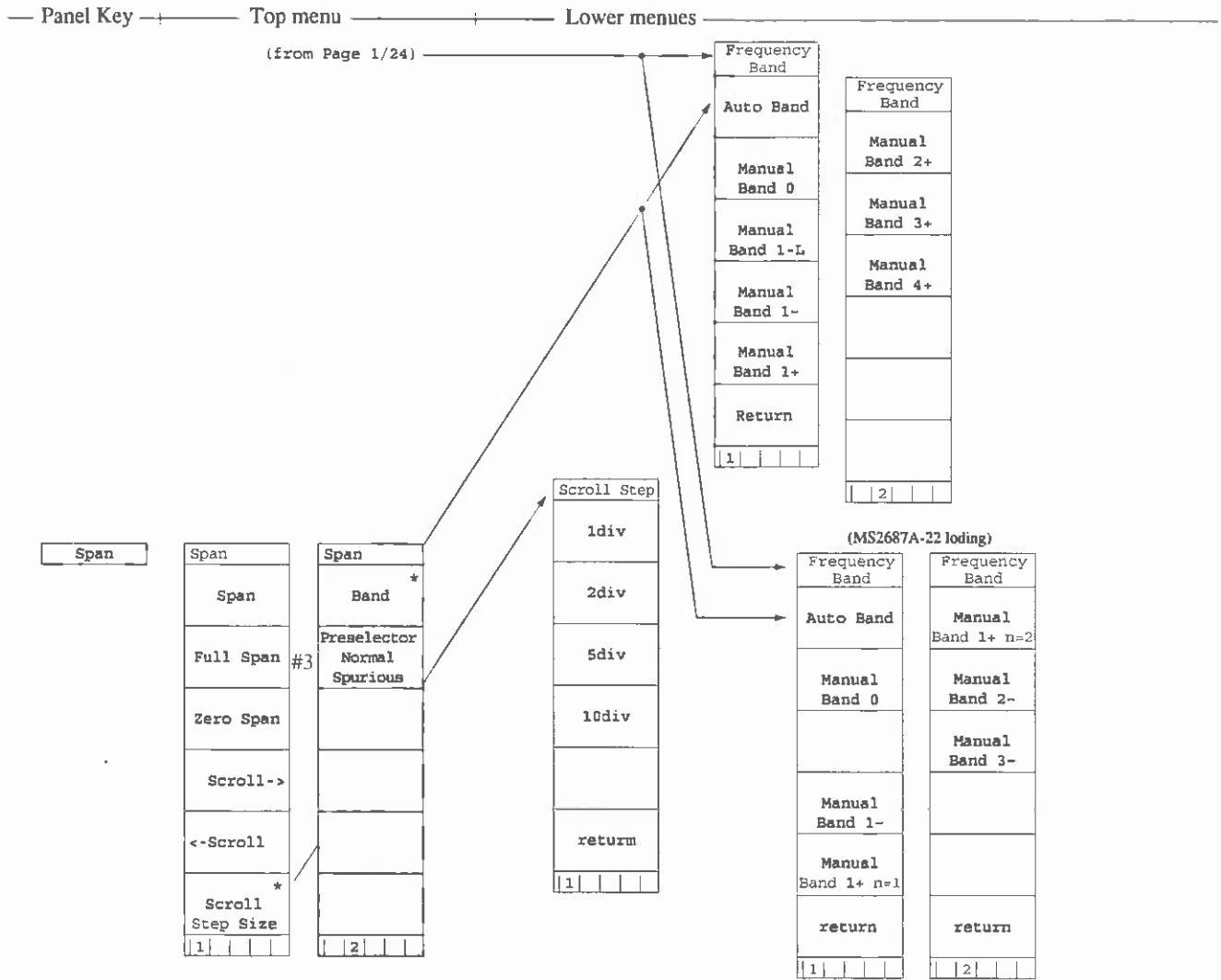

- Set frequency span items, including frequency span, full span, zero span, frequency span scroll, etc.

Menu Tree (3/24)

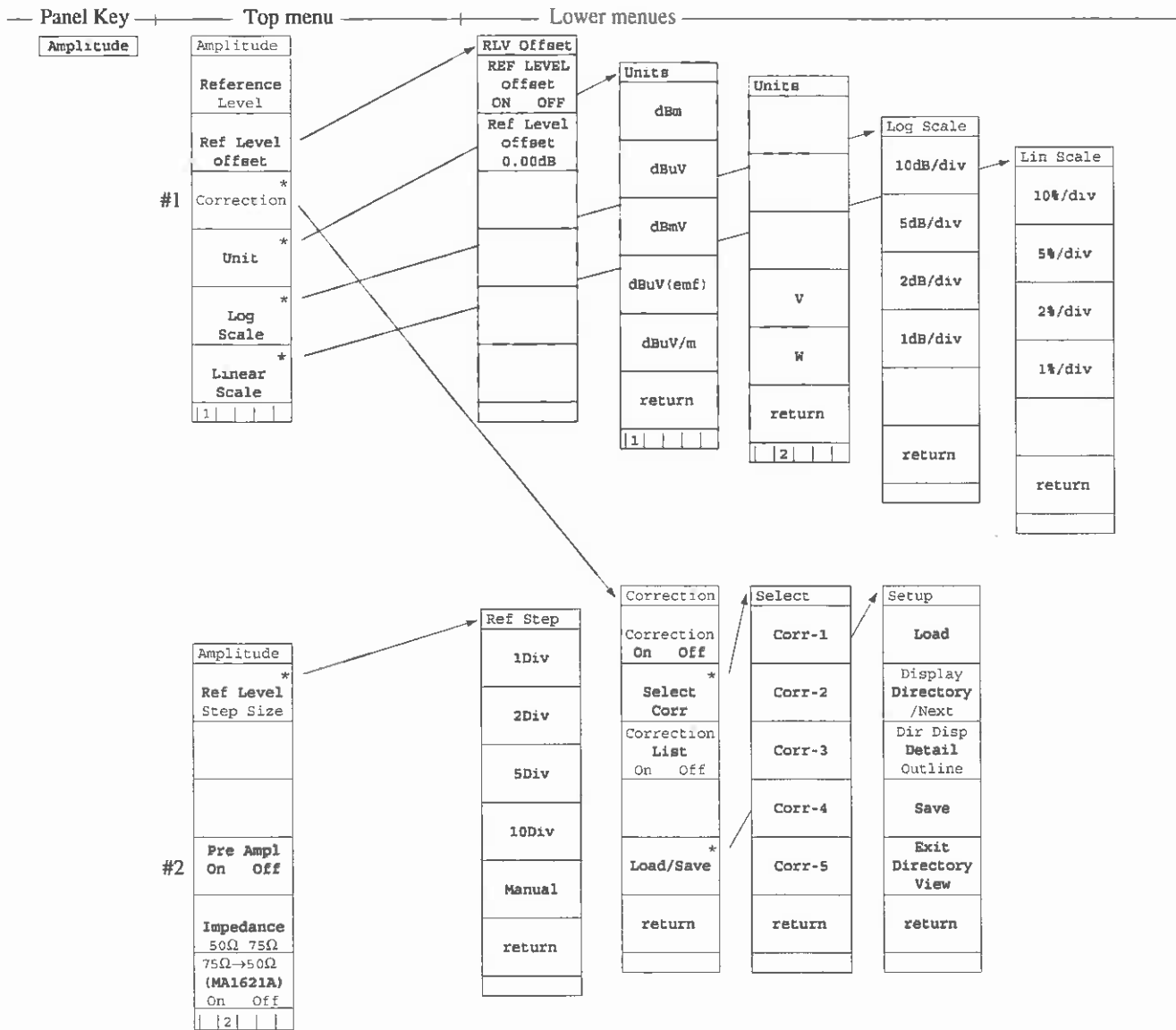

#1 Sets correction (frequency-response characteristics correction) function.

#2 Switches the 20 dB pre-amplifier On/Off.

- Set items along the vertical axis of the screen, including reference level, Peak->RLV, reference level offset, measurement level unit, Log/Lin scale switching, reference level step size, display line, attenuator, pre-amplifier On/Off, 75 Ω impedance, transformer, frequency-response correction, etc.

Menu Tree (4/24)

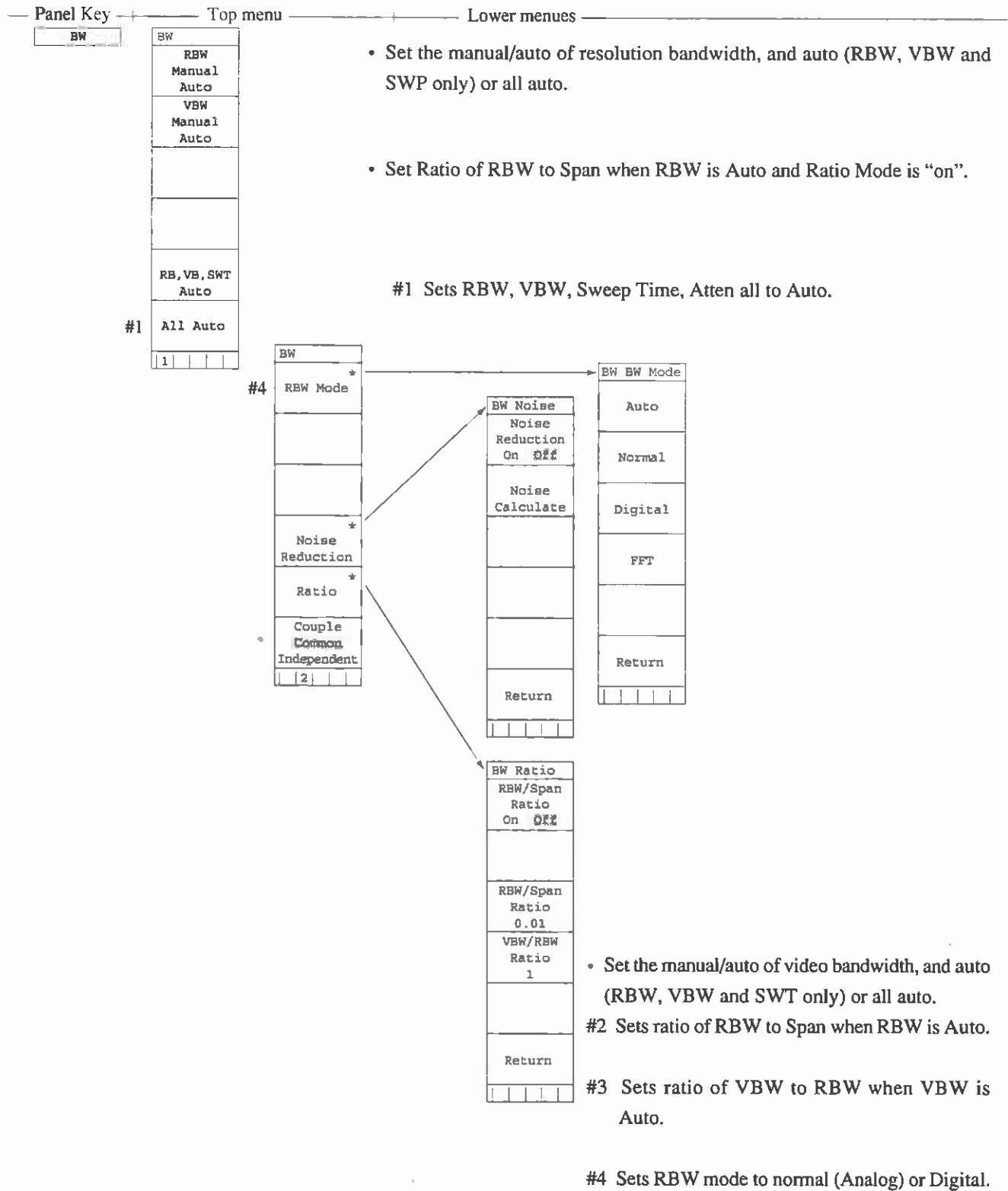

Menu Tree (5/24)

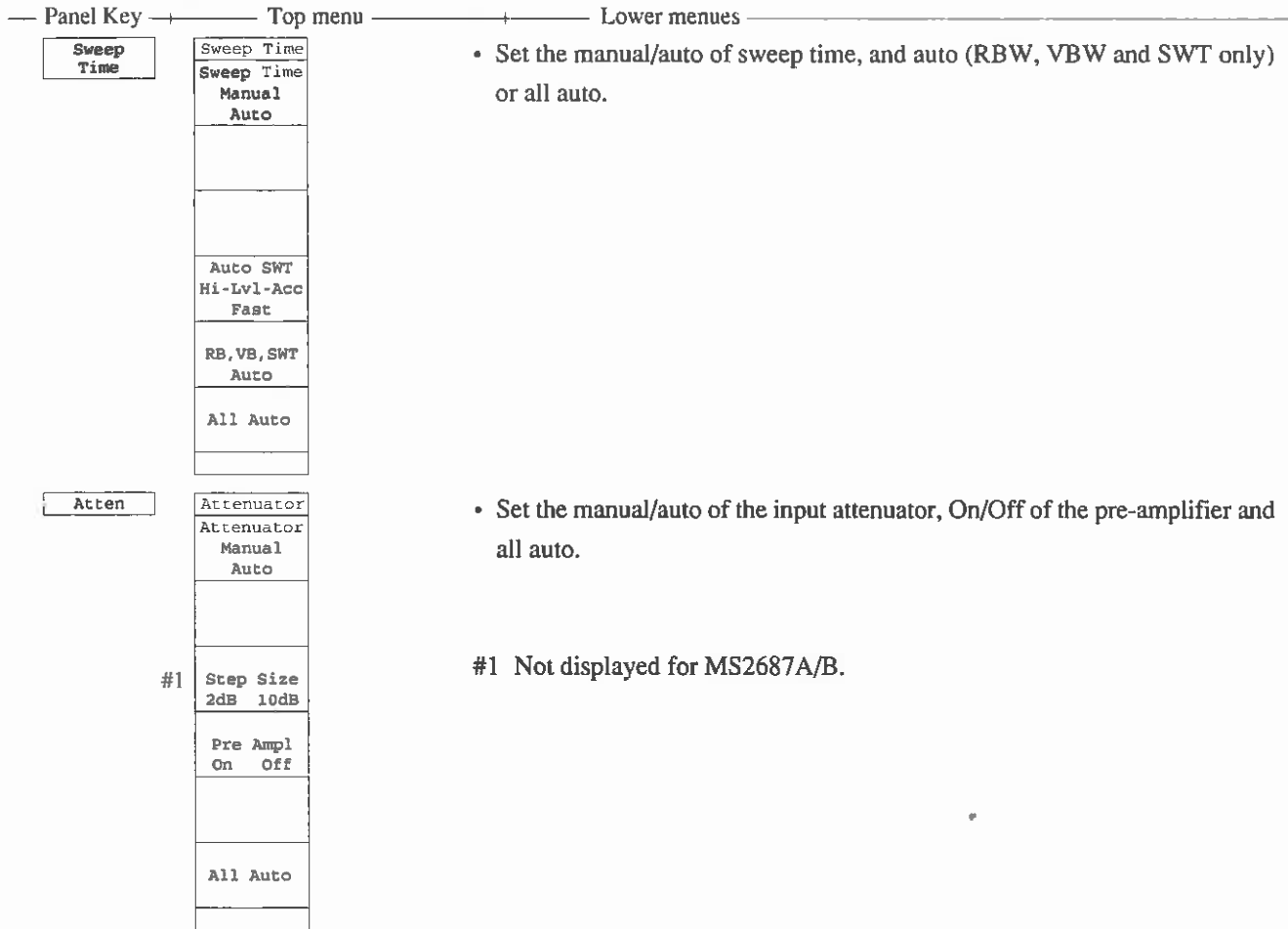

Menu Tree (6/24)

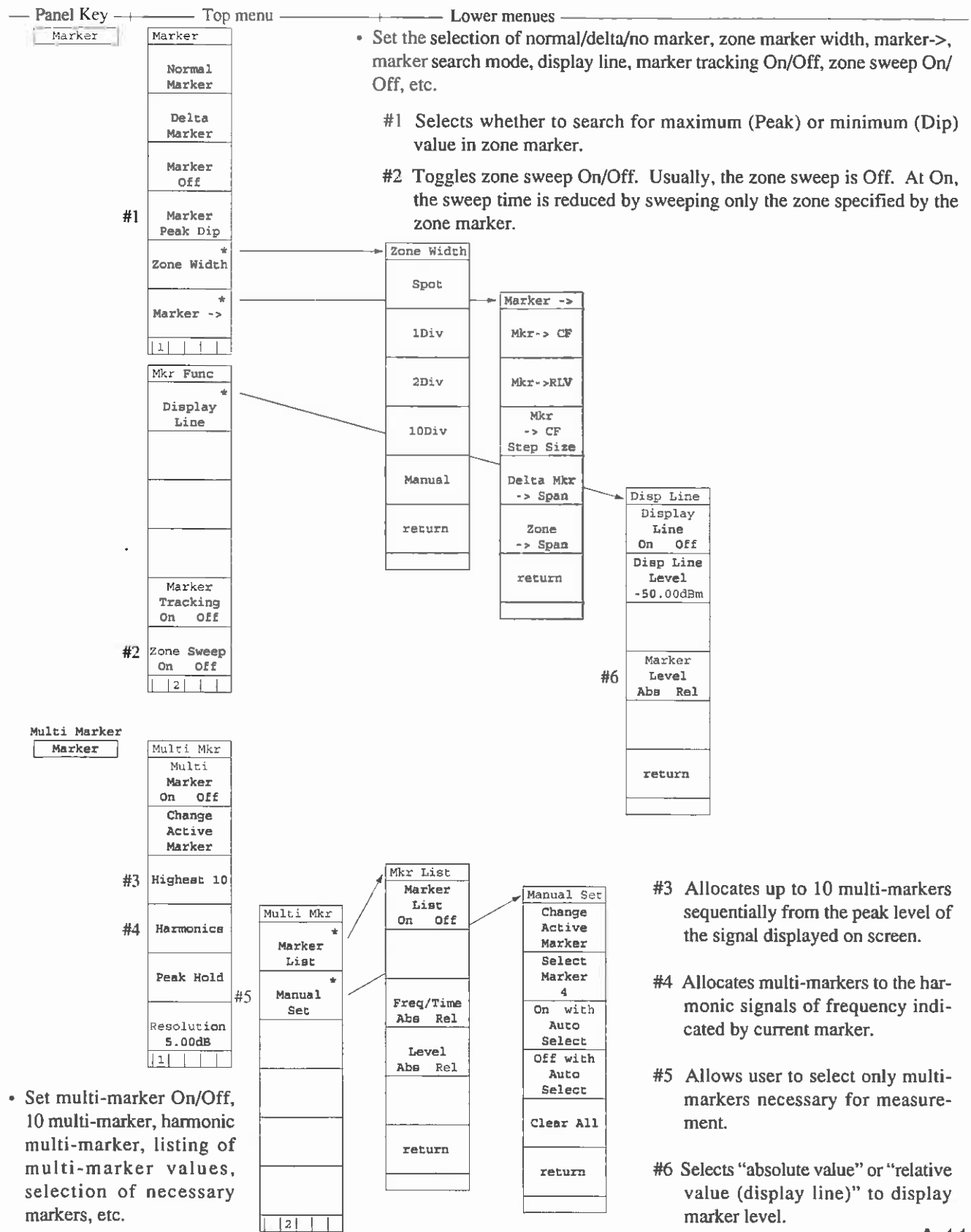

Menu Tree (7/24)

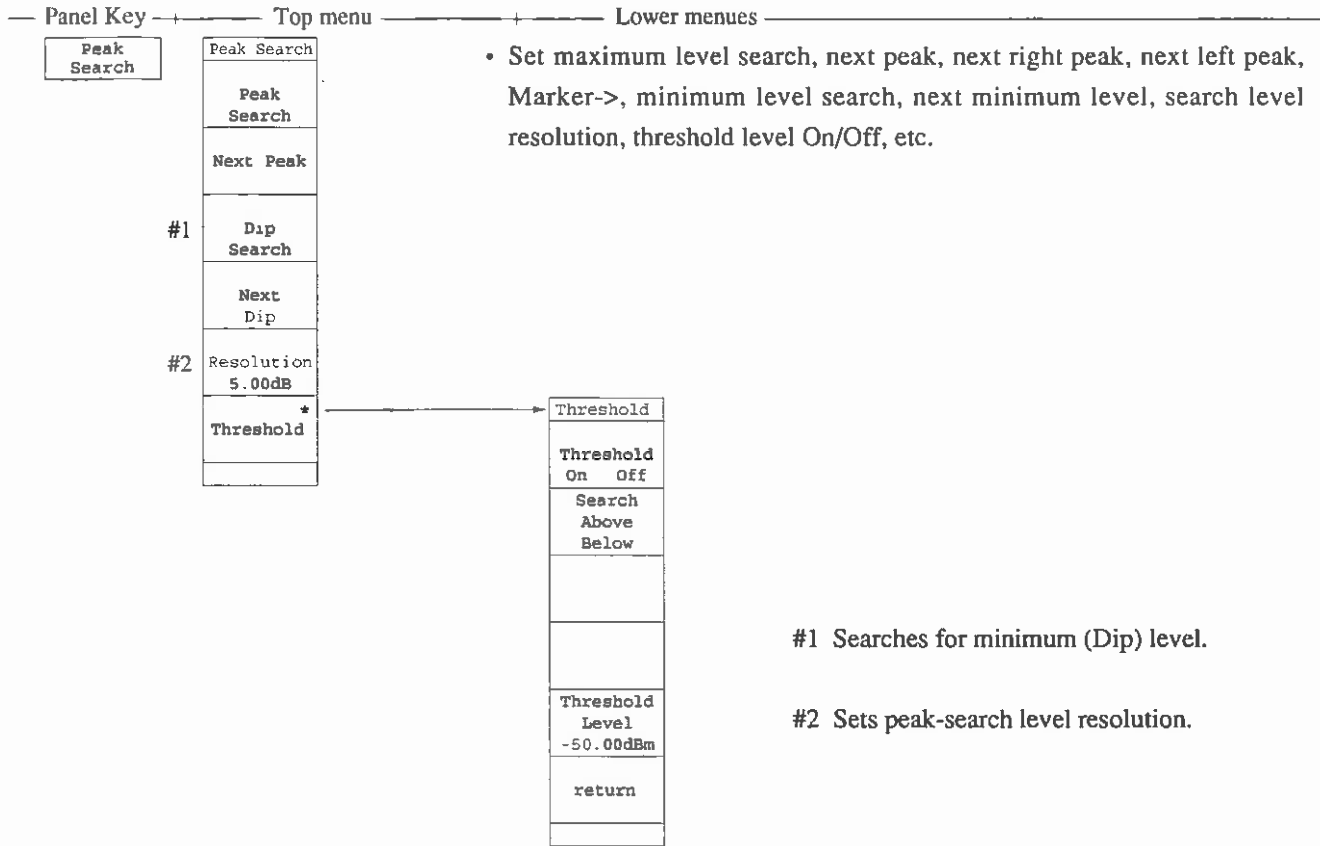

#1 Searches for minimum (Dip) level.

#2 Sets peak-search level resolution.

Marker ->

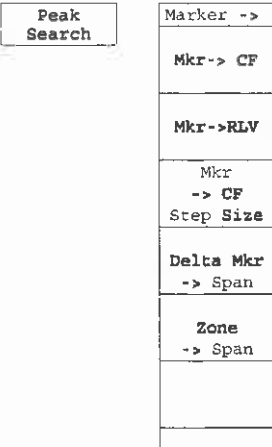

- Set marker value -> center frequency, marker value -> reference level, marker value -> CF step size, delta marker-> span, zone marker -> span, etc.

Menu Tree (8/24)

— Panel Key —+——— Top menu —+——— Lower menus —+—————

Peak
→cf

Peak
→RLV

Single

Continuous
Single

Menu Tree (9/24)

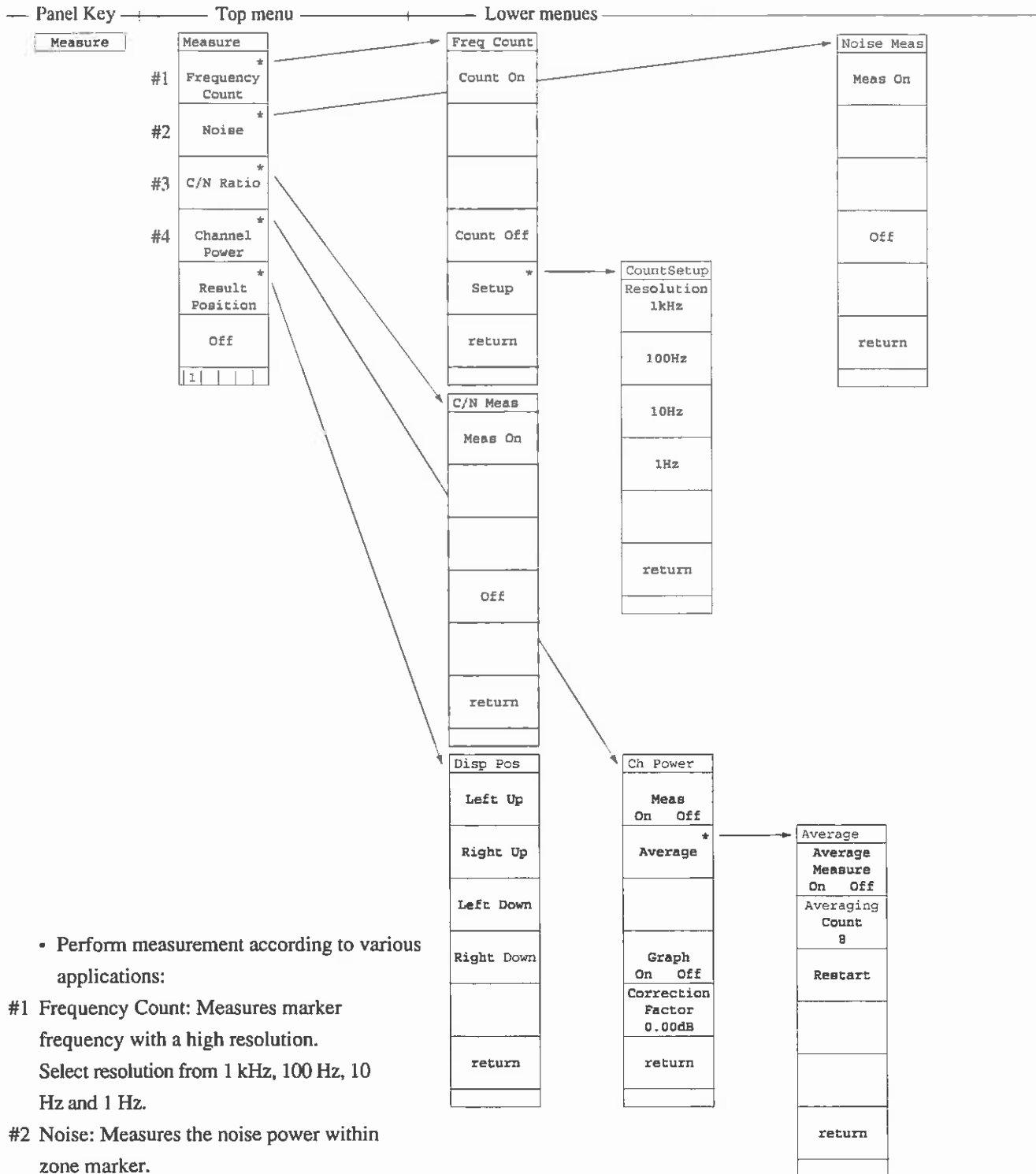

• Perform measurement according to various applications:

#1 Frequency Count: Measures marker frequency with a high resolution.

Select resolution from 1 kHz, 100 Hz, 10 Hz and 1 Hz.

#2 Noise: Measures the noise power within zone marker.

#3 C/N Ratio: Measures the ratio of carrier signal and noise power. Reference marker of the delta marker shall be set to the carrier, and marker's zone width specifies the power measured.

#4 Channel Power: Measures power with in the band indicated by zone marker. It is possible to set an arbitrary calibration value.

Menu Tree (10/24)

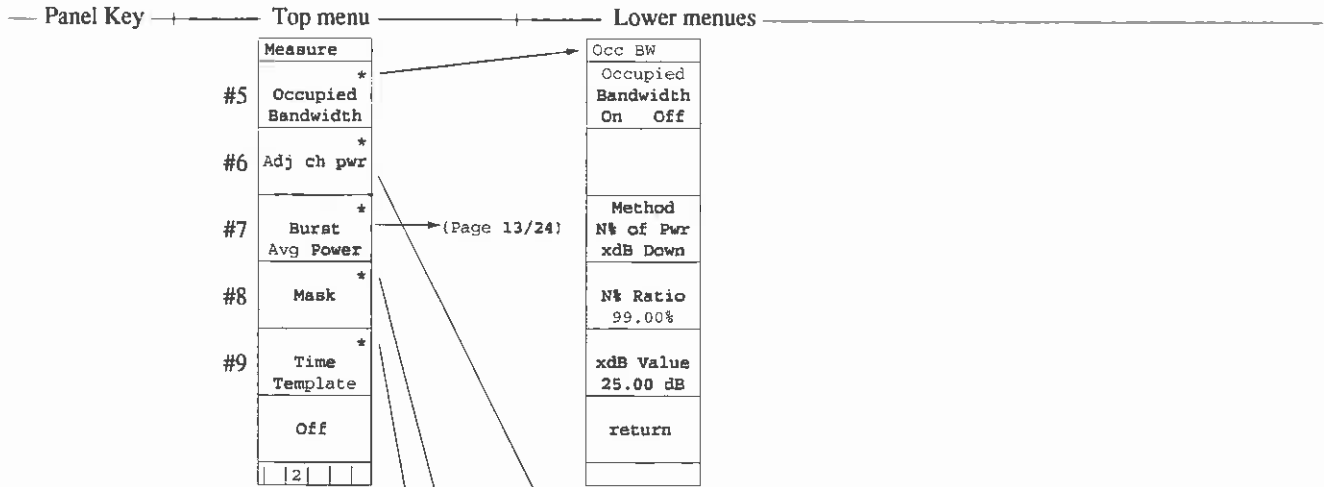

#5 Occupied Bandwidth: Measures the occupied bandwidth. Select the XdB DOWN or N% of POWER mode.

#6 Adj ch pwr: Measures leak power from adjacent channels. Select Channel Separate, Channel Bandwidth and Measurement Mode (Method), On/Off of ACP Graph, On/Off of Channel Center Line and On/Off of Channel BW Line, Upper Channel, Lower Channel or Both Channel, etc.

#7 Burst Avg Power: Measures the mean power of burst signals in the time domain. Select the start/end points.

#8 Mask: Sets Standard Line of the frequency domain and judge Good/NG in relation to the standard line. Select Mask Table, Mask Movement, Measurement Mode, Mask Table Preparation, Load/Save of Mask Table, etc.

#9 Time Template: Sets Standard Line of the time domain and judge Good/NG in relation to the standard line. Select Template Table, Template Movement, Measurement Mode, Template Table Preparation, Load/Save of Mask Table, etc.

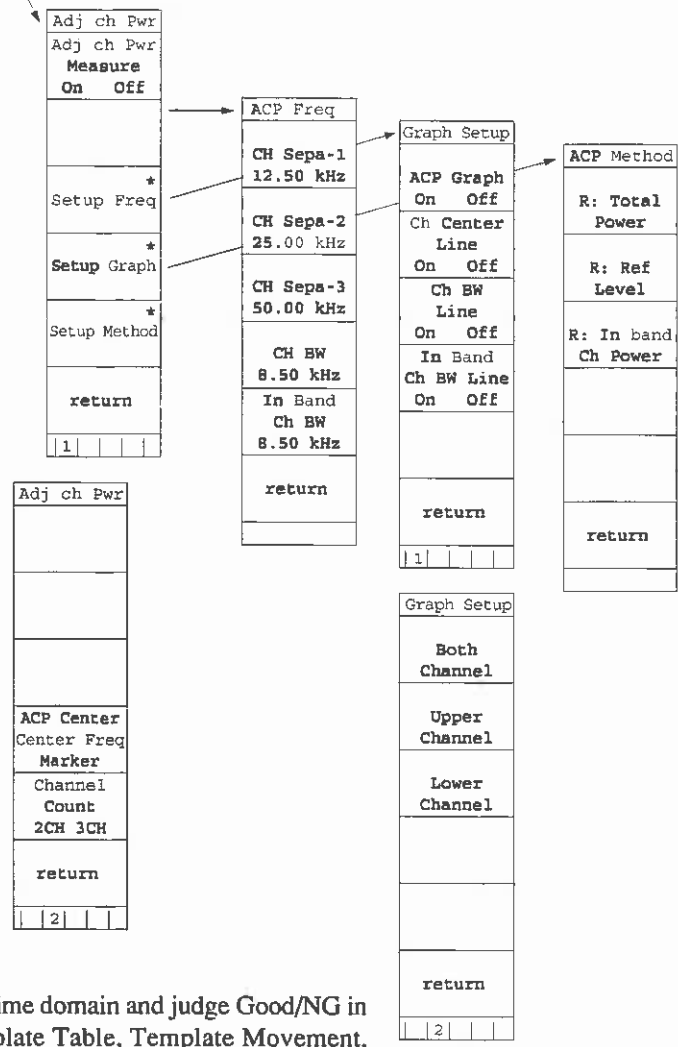

Menu Tree (11/24)

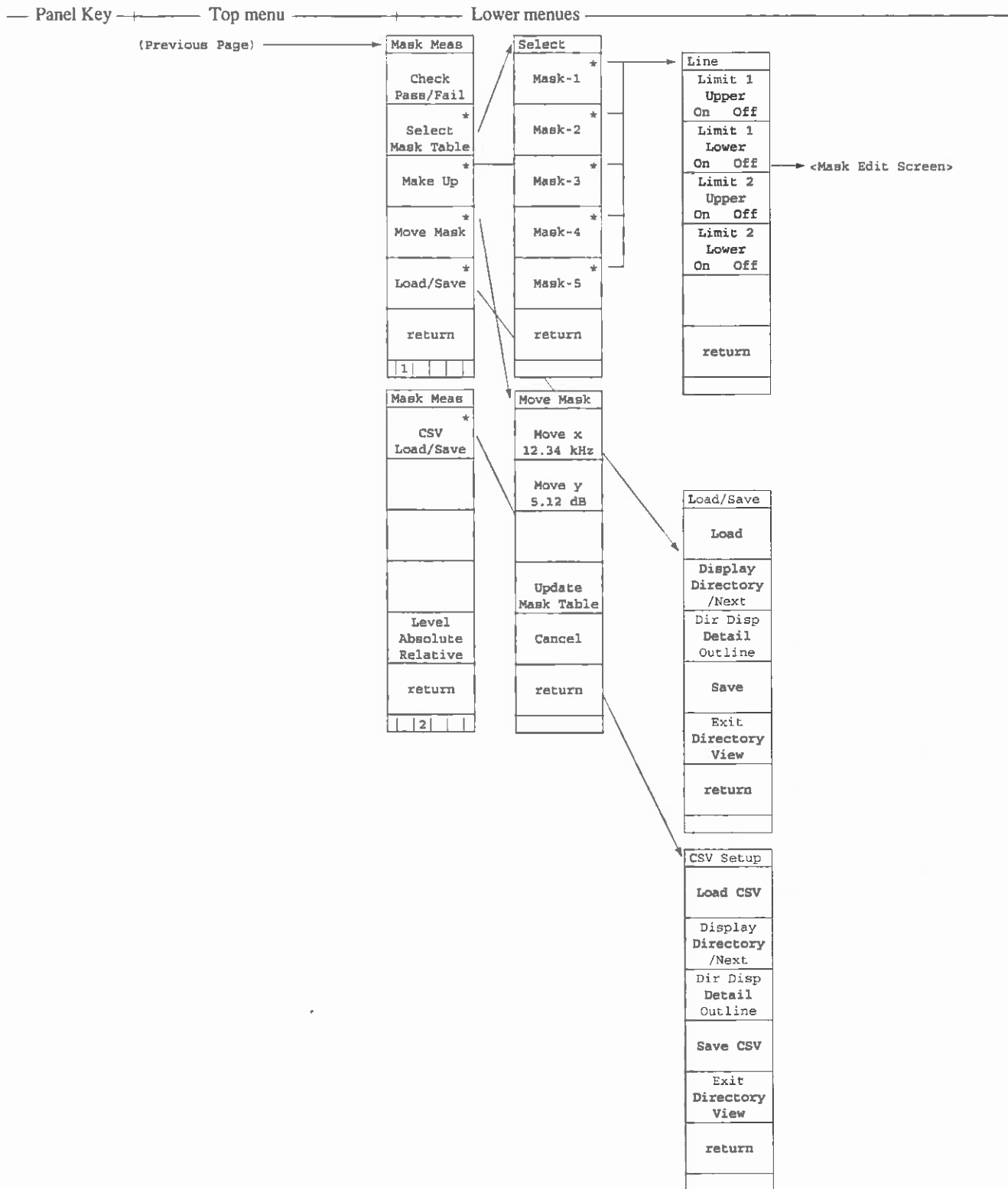

Menu Tree (12/24)

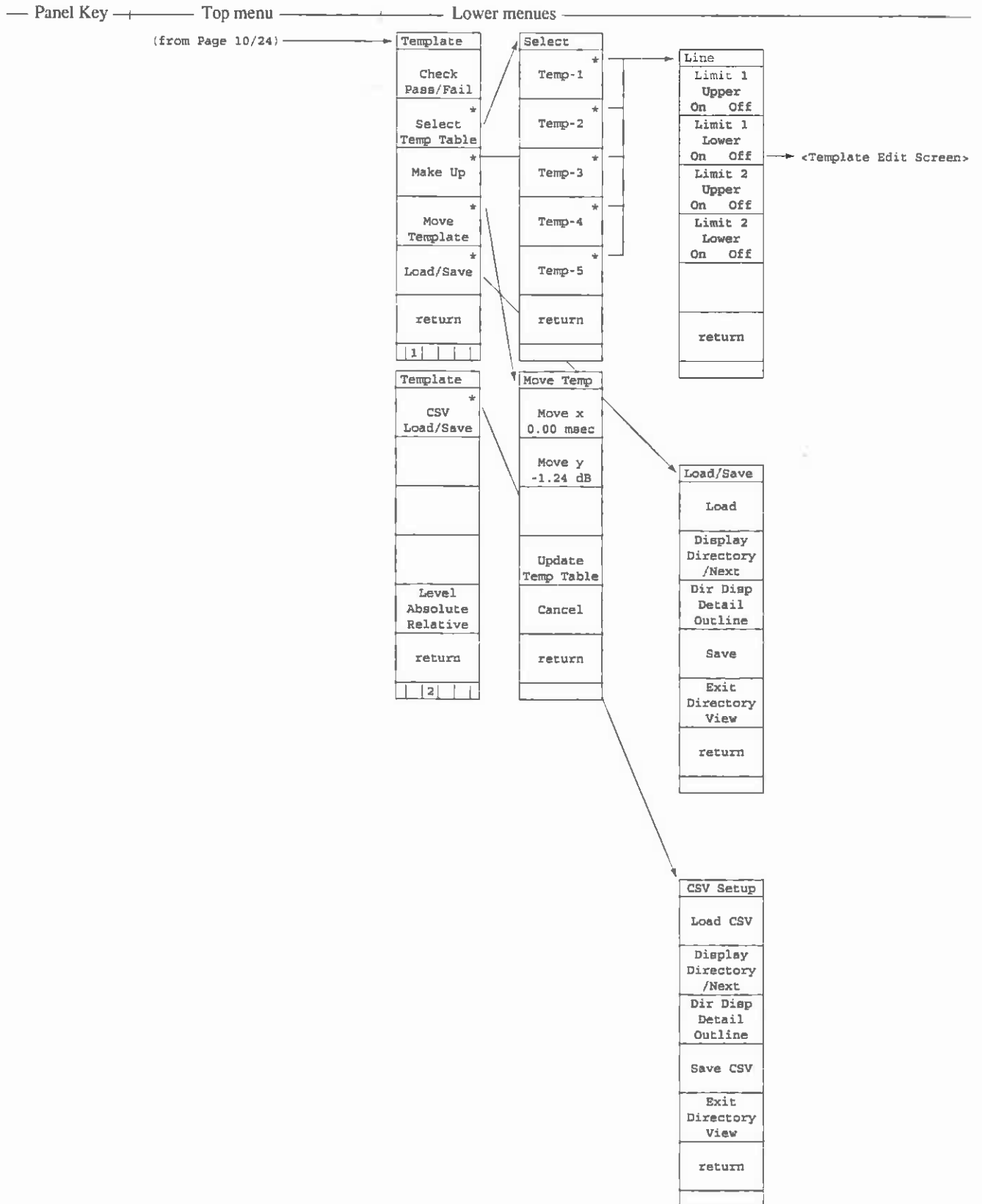

Menu Tree (13/24)



(Page 10/24)

Burst Pwr
Execute
Start Point 100
Stop Point 100
return

Menu Tree (14/24)

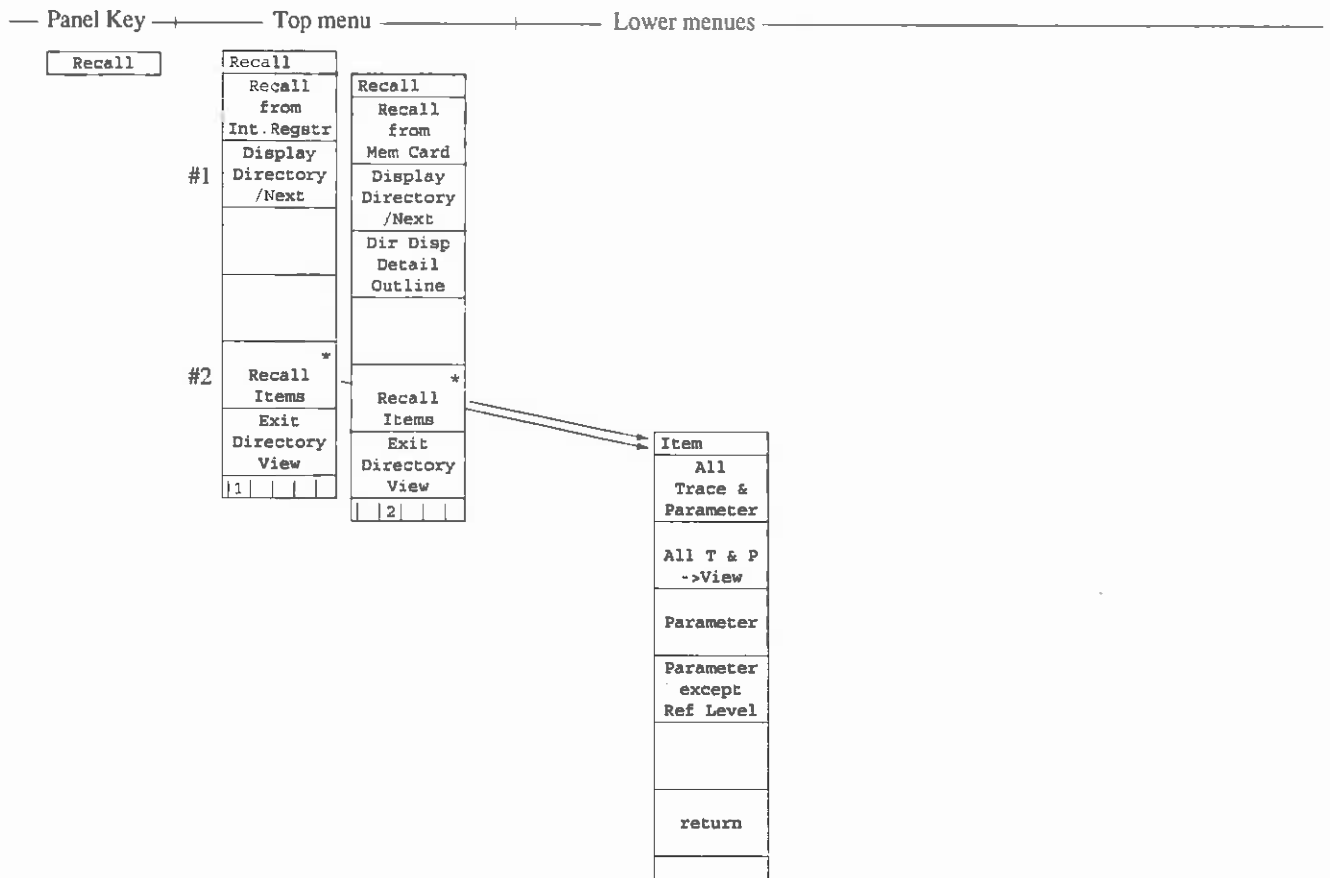

- Read out trace waveform/parameters from the internal memory or memory card. Select recall addresses and media/items, and display file directories.

#1 Displays list of internal-memory directories.

#2 Specifies items to be recalled
(trace waveform, parameter, etc.).

Menu Tree (15/24)



Save
Recall

Save
Save to Int. Register
Display Directory /Next
Exit Directory View
1

- Save trace waveform/parameters to the internal memory or memory card. Select saved media, and display file directories.

Save
Save to Mem Card
Display Directory /Next
Dir Disp Detail Outline
Save Wave* to CSV File
Exit Directory View
2

Save Wave to CSV
Save Wave to CSV File
Display Directory /Next
Dir Disp Detail Outline
Exit Directory View
return

Menu Tree (16/24)

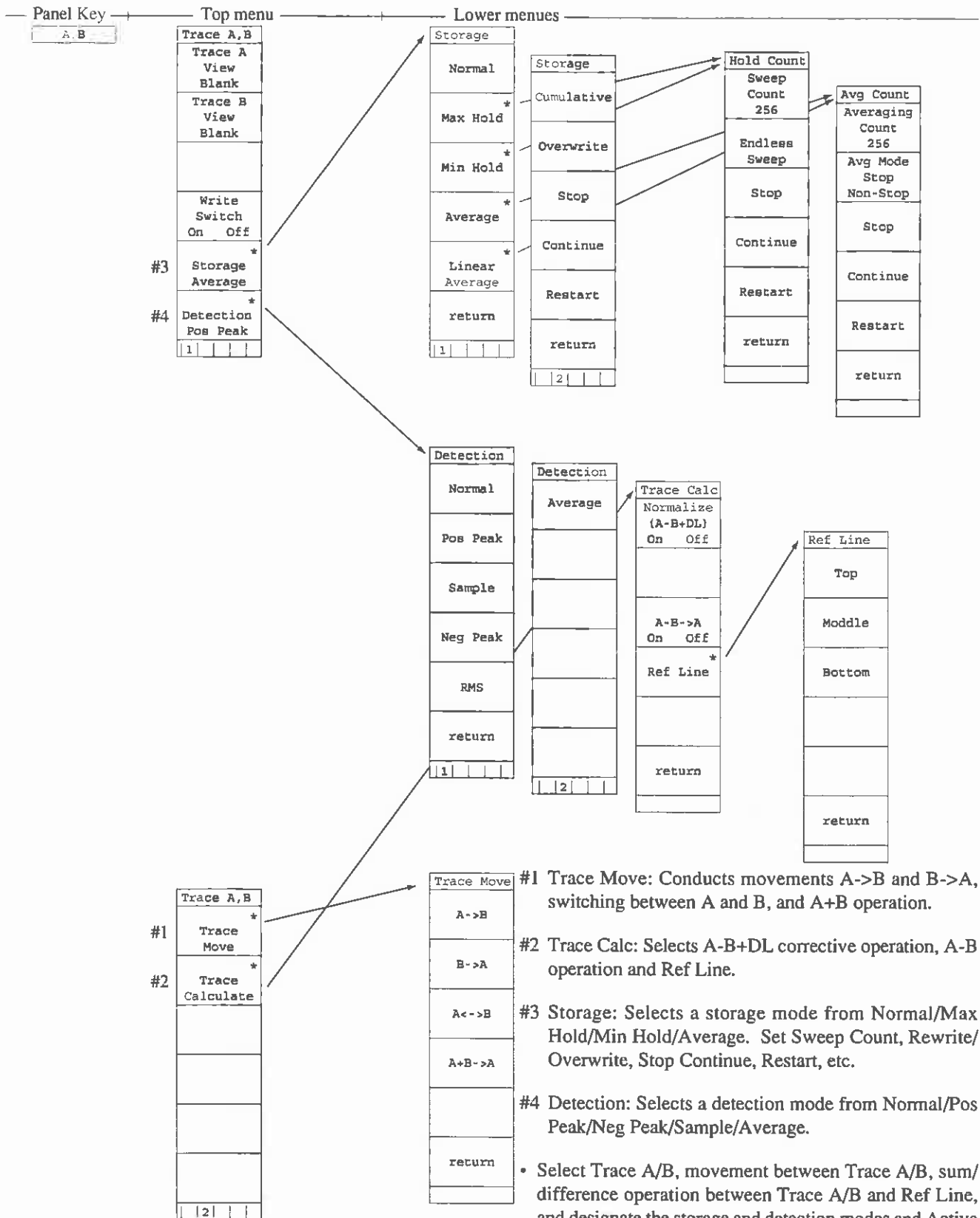

Menu Tree (17/24)

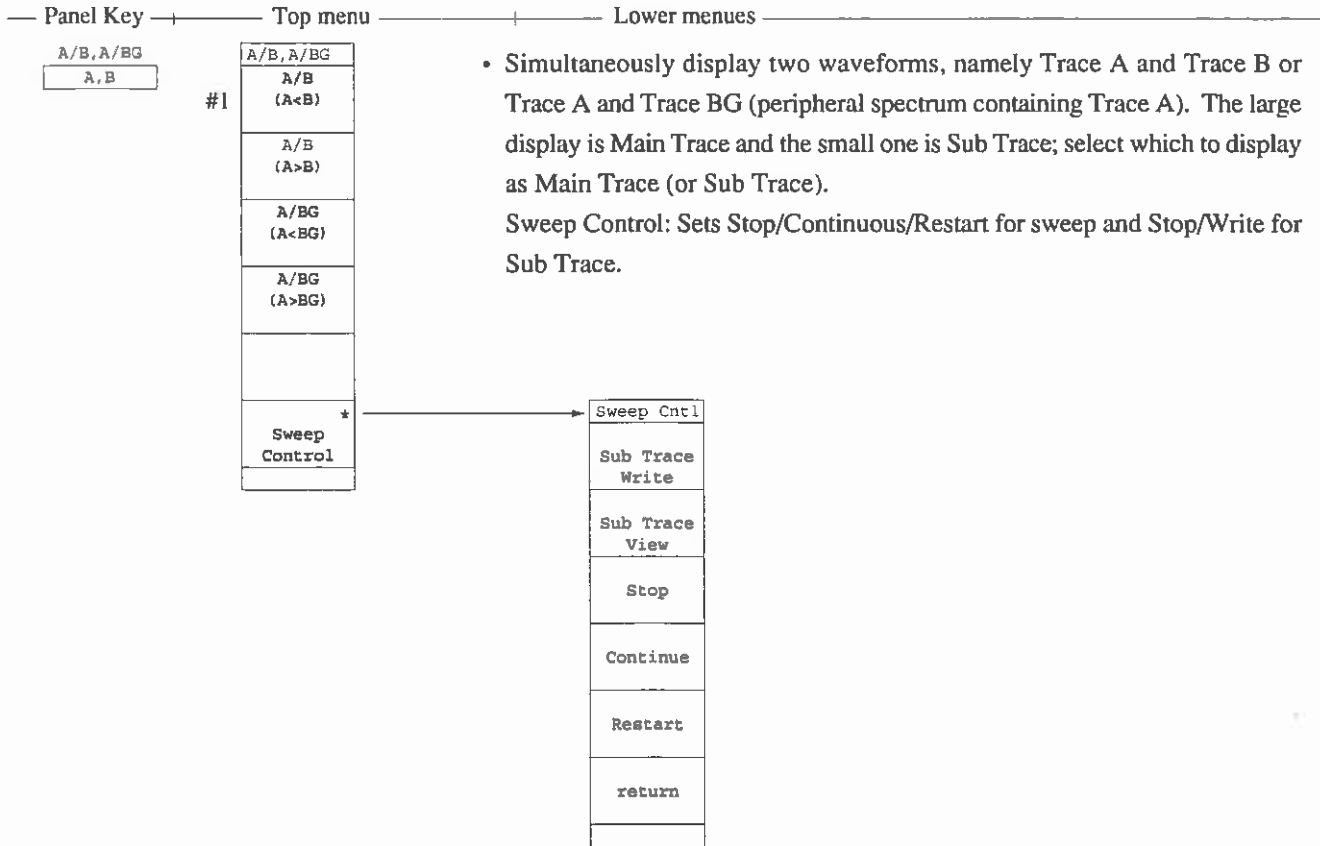

#1 Displays two traces A and B simultaneously at top and bottom of screen. The trace-B display is the larger at this time.

Menu Tree (18/24)

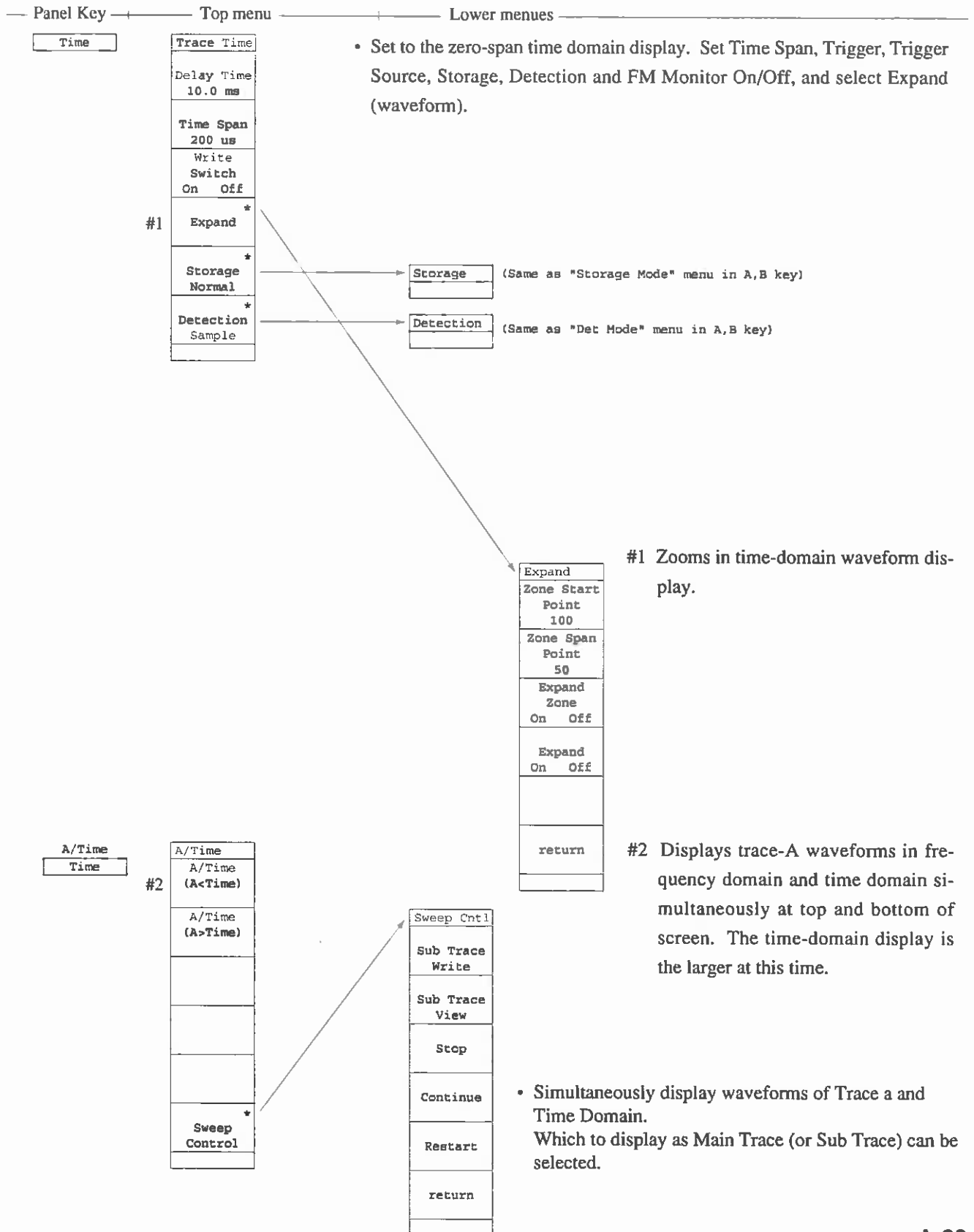

Menu Tree (19/24)

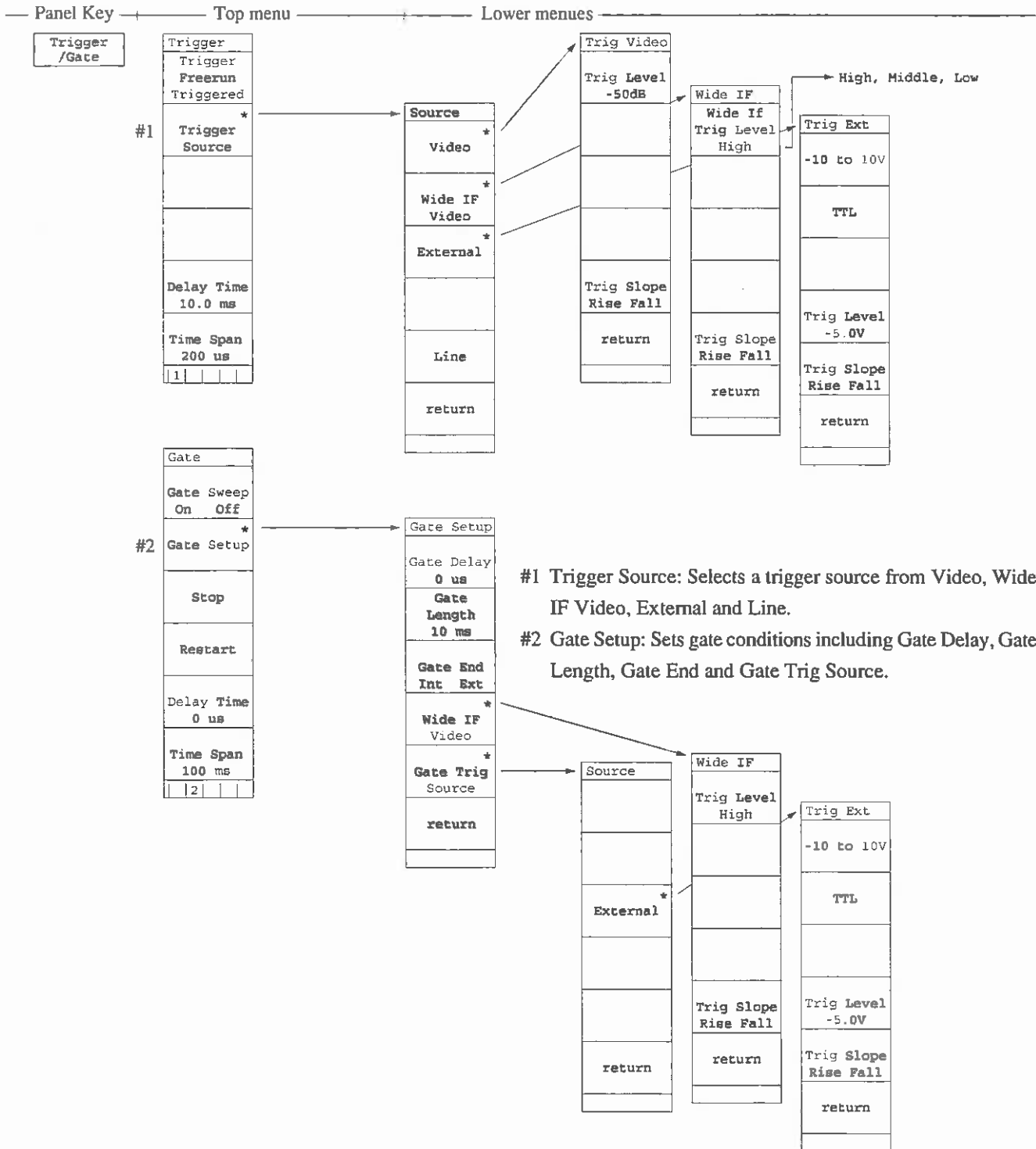

- Set gate functions for controlling the sweep start trigger and the writing of waveform data. Set the trigger mode, trigger source, trace time, delay time and time span. Select On/Off, Stop and Restart of Gate Sweep.

Menu Tree (20/24)

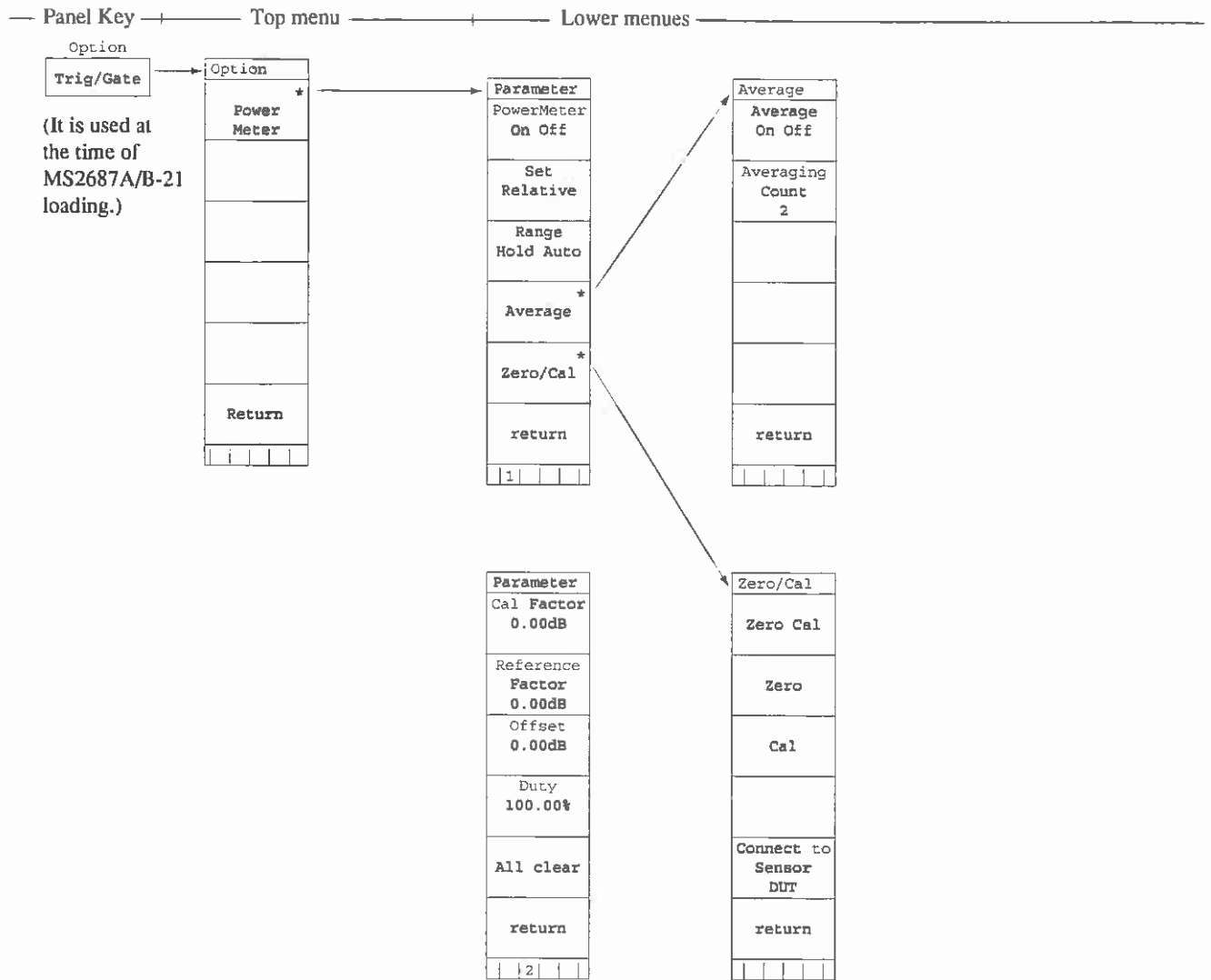

- In the time of MS2687A/B-21 loading, high accuracy electric power measurement in the frequency range of 100 kHz to 32 GHz can be performed.

Menu Tree (21/24)

Panel Key ———— Top menu ———— Lower menus ————

Copy

Copy Cont
Copy

Copy Cont
Copy to Printer
BMP File
Paper Feed
Stop Print
* Printer Set up
* BMP File Set up
i

Printer
BJ-M70 (ESC/P)
HP815C
return

- Set Printer/memory card to hard-copy the screen. Set Printer/memory card, Printer (model)/memory card (model), Paper Feed, Stop Printer, etc.

BMP File
Color
Monochrome
* BMP File Save Media
return

Save Media
Memory Card
Internal Memory
return

- Saves the screen image data in memory card by BMP format (MS-DOS bit-map data format).

Menu Tree (22/24)



Color

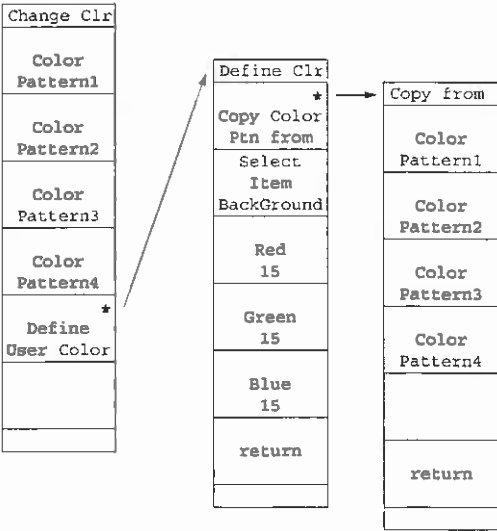

Menu Tree (23/24)

Panel Key → Top menu → Lower menus

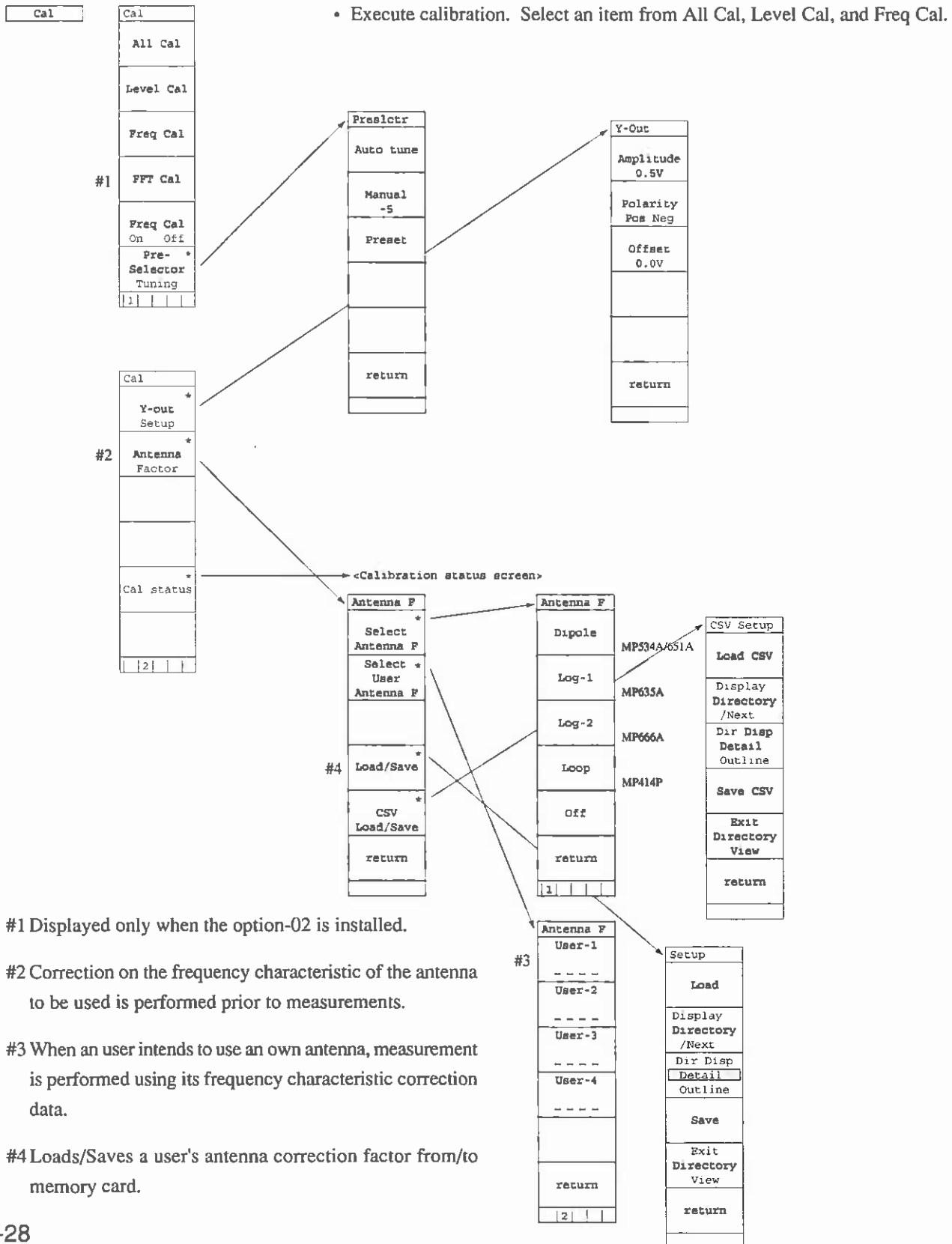

#1 Displayed only when the option-02 is installed.

#2 Correction on the frequency characteristic of the antenna to be used is performed prior to measurements.

#3 When an user intends to use an own antenna, measurement is performed using its frequency characteristic correction data.

#4 Loads/Saves a user's antenna correction factor from/to memory card.

Menu Tree (24/24)



Preset

Preset
Preset All
Preset Sweep controll
Preset Trace Parameters
Preset Level Parameters
Preset Freq/Time Parameters

- Initialize measurement parameters. Select one from All, Sweep, Trace, Level and Freq/Time.

Local

Disp On/Off

System

System
Erase Warm up Message
Data Points 1001 501
NLP-1200 Correction On Off

Config mode Menu Tree

MS2681A/MS2683A/MS2687A/MS2687B Config Menu Tree (1 /2)

Panel Key ———— Top Menu ———— Lower Menu & Entry ————

Config

-Display-						
[Comment]		<table border="1"> <tr><td>Title</td></tr> <tr><td>Clock</td></tr> <tr><td>Clock & Title</td></tr> <tr><td>Off</td></tr> </table>	Title	Clock	Clock & Title	Off
Title						
Clock						
Clock & Title						
Off						
[Title]						
[Date Format]		<table border="1"> <tr><td>YYYY/MM/DD</td></tr> <tr><td>MMM-DD-YYYY</td></tr> <tr><td>DD-MMM-YYYY</td></tr> </table>	YYYY/MM/DD	MMM-DD-YYYY	DD-MMM-YYYY	
YYYY/MM/DD						
MMM-DD-YYYY						
DD-MMM-YYYY						
-Setting-						
[Date]		<table border="1"> <tr><td>Year</td></tr> <tr><td>Month</td></tr> <tr><td>Date</td></tr> </table>	Year	Month	Date	
Year						
Month						
Date						
[Time]		<table border="1"> <tr><td>Hour</td></tr> <tr><td>Minute</td></tr> <tr><td>Second</td></tr> </table>	Hour	Minute	Second	
Hour						
Minute						
Second						
[RGB Output]		<table border="1"> <tr><td>On</td></tr> <tr><td>Off</td></tr> </table>	On	Off		
On						
Off						
[LCD Brightness]		<table border="1"> <tr><td>1 to 5</td></tr> </table>	1 to 5			
1 to 5						
[Buzzer]		<table border="1"> <tr><td>On</td></tr> <tr><td>Off</td></tr> </table>	On	Off		
On						
Off						
[Window Cursor Mode]		<table border="1"> <tr><td>Turn</td></tr> <tr><td>Stop</td></tr> </table>	Turn	Stop		
Turn						
Stop						
-Power On-						
[Screen]		<table border="1"> <tr><td>Spectrum</td></tr> <tr><td>System</td></tr> <tr><td>Last</td></tr> </table>	Spectrum	System	Last	
Spectrum						
System						
Last						
[Initial]		<table border="1"> <tr><td>Before Power Off</td></tr> <tr><td>Fixed State</td></tr> </table>	Before Power Off	Fixed State		
Before Power Off						
Fixed State						

- 1) Press Set key to select Top menu in Config menu after moving the cursor with knob or step key. Press Set key to select Lower menu after moving the cursor.

MS2681A/MS2683A/MS2687A/MS2687B Config Menu Tree (2/2)

Panel Key Top Menu Lower Menu & Entry

-Copy Control-

[Copy To]

Printer
BMP File To Mem Card

[Printer Set up]

BJ-M70 (ESC/P)
HP815C (HP)

[BMP File Set up]

Color
Monochrome

Interface**-Interface-**

[Connect To Controller]

GPIB
RS232C

-GPIB-

[My Address]

00 to 30

-RS232C-

[Band Rate]

1200 to 115200 bps

[Parity]

Even
Odd
Off

[Data Bits]

7 bits
8 bits

[Stop Bit]

1 bit
2 bits

[XON/XOFF Flow Control]

On

File Operation

Refresh Screen
Sort
Format
Delete
Write Protect
Back Screen →

Appendix B Keywords Index

The following lists the main keywords used in this operation manual and the number of the pages on which they are used. Use it to search for the soft keys, function descriptions, etc.

[KEYWORDS INDEX]

Keyword	Page
→CF	4-6
→RLV	4-6
←Scroll	2-12
1 div	2-12 3-4
10%/div, 10dB/div	2-15
50Ω,75Ω	2-16
*	1-6
A) A on B	5-8
A/BG	5-11
A/Time	5-14
A+B←A	5-6
A-B→A On Off	5-7
A/B, A/BG	5-9
A/BG	5-9
A<Time	5-14
Above Below	3-20
Abs	3-10
Absolute Value	3-10 3-12
Active Marker	3-13 3-14
Active Trace	5-8
Active Trace A B	5-8
add	5-6
Adj ch pwr Measure	12-6
Adjacent Channel Leakage Power	12-26 12-28
All Auto	7-5
All Cal	8-4
All Trace&Parameter	10-9
antenna factor	8-7
Atten	7-10
Auto mode	7-6 7-8 7-10
Auto Select	3-14
Auto tune	4-4
Automatic Calibration Function	8-3
Automatic Tuning	4-4
A>B	5-9
A>BG	5-9

Keyword	Page
Average	5-15 5-17 5-18
average value	12-14
averaging	5-20
Averaging Count	5-18
Averaging Function	5-18
Avg Mode Stop Non-Stop	5-18
A→B	5-6
A↔B	5-6
B) Back Ground (BG)	4-4
before the trigger	5-12
Below	3-20
BG zone	5-4
BJ-M70	11-4
Both Channel	12-29
Bottom	5-7
Burst Average Power	12-7
Burst Avg Power	12-7 12-15 12-21
Burst Wave	12-20
burst wave	6-15
burst wave gate control signal	6-8
B→A	5-6
C) C/N Ratio	12-5 12-8
C/N Ratio Measure	12-5 12-8
CAL	8-3
Cal Status	8-4
calculates the average data	5-18
Calibration Function	8-3
Carrier-Off	12-23
Center	2-3
CF Step Size	2-7
Ch BW	12-6
Ch Sepa-1	12-6
Chack Pass/Fall	12-6
Change Active Marker	3-14
Change Color	9-5
Check Pass/Fall	12-6
Clear All	3-15
Clock	9-4
Color Patern	9-5

Keyword	Page	Keyword	Page
Continue	5-10 5-17 5-18	Display Type	9-4
Continuous	6-3	E) Entry area	1-4
Continuous Sweep Mode	6-3	Executing Hard Copy	11-6
Copy	1-10	Expand	5-12
Copy Cont	1-10	Expand On	5-28
Corr-1	8-8	Expand zone	5-4
Correction	2-22 8-7	Expand Zone On Off	5-28
Correction Coefficient	2-22	expansion zone	5-28
correction factor	8-8	External	6-9
Count	12-4	External Trigger	6-8
Coupled Common	7-12	F) File	10-7 10-10
Coupled Function	7-1	File Directory	10-8
Coupled Function Common	7-12	Format	10-10
Cumulative	5-16 5-17	Freerun	6-5
current marker	3-4 3-7	Freq/Time Abs Rel	3-12
D) Date	9-9	Frequency Count	1-8 12-4
dBc/Hz	12-9	frequency domain	5-5 5-6
dBm/ch	12-11	Frequency drift	6-13
dB μ V, dBmV	2-13	Frequency Measurement	12-4
Define User Color	9-5	Frequency range	5-4
Delay Time	5-12 6-10	frequency span to 0	5-26
Delete	10-10	Full Span	2-10
Delta Marker	3-8	G) Gate Control Signal	6-17
Delta Mkr→Span	3-24	Gate Delay	6-17 6-18
Detail	2-22 10-7 10-8	Gate End Int Ext	6-18
Detecting Peaks	4-3	Gate Length	6-17 6-18
Detection	5-12 5-23	Gate Setup	6-18
Detection Mode	5-22 5-23	Gate Sweep On Off	6-18
digital averaging	5-20	Gate Trig Source	6-18
Dip	3-9	H) Harmonics	3-12
Dip Search	3-18	Highest 10	3-11
Dir Disp Detail	2-22 10-5 10-7	HP815C	11-3 11-5
Dir Disp Outline	2-22 10-5 10-7	I) Impedance transformer	2-15
Direct Plotting	11-3	Independent	9-4
Directory	2-22 10-5 10-7	Insert	12-9
Directory/Next	2-22 10-5 10-7	instantaneous signal level	5-24
Disp Line Level	3-10	Instant Normalize	14-4
Display Line	3-10		
Display modes	5-3		

Appendix B Keywords Index

	Keyword	Page		Keyword	Page
	Impedance	2-16		Mkr→RLV	3-22
L)	Leakage Power Measurement	12-23		More key	1-6
	Level Abs Rel	3-12		Move Mask	12-6
	Level Cal	8-4		Move Template	12-6
	Level Correction	8-7		Moving the Measurement Point	4-5
	Level Frequency	2-22		Moving the Trace	5-6
	Level Frequency Correction Coefficient	2-16		Multi Marker	3-11 3-15
	Level Range	2-13		Multimarker Off	3-15
	Line	6-6	N)	N% of Pwr	12-5 12-18
	Line Trigger	6-6		Neg Peak	5-22 5-23 5-24
	Linear Scale	2-13 2-15		Next Dip	3-19
	Load Corr Set	2-22		Next Peak	3-17
	log scale	2-13 2-15		Noise Measure	12-4 12-12
M)	MA1621A	2-17 2-21		Non-Stop	5-18
	Main Trace	5-9 5-11 5-14		Normal	5-15 5-17 5-22
	Manual setting	7-6 7-9 7-11			5-23 5-24
	marked by an asterisk	1-6		Normal Marker	3-7
	marker	3-3		Normalize (A-B+DL) On	5-7
	marker functions	3-3		Normal/Sprions Mode	2-9
	Marker Level Abs Rel	3-10	O)	observation of harmonic waves	3-23
	Marker List	3-12		observe power line-related hum waveform	6-10
	Marker Mode	3-7		Occ BW Measure	12-5 12-18
	Marker Off	3-9		Occupied Frequency Bandwidth	12-18
	Marker Search	3-9 3-15		off with Auto Select	3-14
	Marker Tracking	6-13		Outline	2-22 10-7 10-8
	Marker Values	3-21		Overwrite	5-8 5-16 5-17
	Mask	12-6	P)	page learning function	1-8
	MASK Creation Screen	12-36		Paper Feed	11-4
	Max Hold	5-15		Parameter except RFL	10-9
	Measure	1-8 12-3		Pass/Fail Judgment by Mask	12-6
	Measuring Noise Power	12-4		PDC	12-15 12-19 12-34
	Measuring Occupied Bandwidth	12-5		Peak→CF	4-5
	Memory Card	10-4 12-30		Peak→RLV	4-5
	Memory Directory	10-6		Peak search	3-16
	Middle	5-7		Peak Signal	4-4
	mistake	1-3		PHS	12-15 12-19 12-33
	mixer level	7-11		Pos Peak	5-22 5-23 5-24
	Mkr→CF	3-22		Post-trigger	6-11
	Mkr→CF Step Size	3-23		Power Measurement	12-10 12-12

Keyword	Page	Keyword	Page
Power On Screen	9-8	Setting Reference Level	2-17
Pre Ampl	2-14 7-10	Setting Time Domain	5-26
Pre-trigger	6-11	Setup	12-6
Preset	1-3	Setup Corr	2-22 8-8
Printer	11-3	Signal Tracking	6-13
Printer Setup	11-5	Single	6-4
R) RB, VB, SWT Auto	7-5	Single Sweep Mode	6-4
RBW	7-5	small display	5-9
Recall	10-7	Span	2-3
Recall Item	10-7 10-9	Spot	3-4
Recalling From Memory	10-7	spot marker	3-5
Ref	10-9	Spurious Radiation Strength	12-20
Ref Level Offset	2-14	Start	2-3
Ref Level Step Size	2-14	Start freq	2-6
Ref Line	5-7	Start Point	12-7
reference marker	3-8	Step	2-4
Rel	3-10 3-12	Step Size	2-4
Relative Value	3-12	Stop	2-6 5-10 5-17 6-18
resolution	3-19	Stop Continue	5-18
resolution dB	3-19	Stop freq	2-5
Restart	5-10 5-17 6-18	Stop Non-Stop	5-18
S) S/N	5-19	Stop Point	12-7
S/N improvement	5-20	Storage Mode	5-15 5-17
Sample	5-22 5-23 5-24	Storage	5-12 5-17 5-18
sample point	5-24	Sub Trace	5-11 5-14
Save	10-5	Sub Trace Write View	5-10
Save Corr Set	2-22	subtracts	5-7
Save to Mem Card	10-5	Sweep Mode	6-3
Scroll→	2-10	Sweep Time	7-4
Scroll Step Size	2-10	Swp Contl	5-10
Search	3-16	system	9-10
Search Above Below	3-20	T) threshold	3-20
Search Resolution	3-19	Time Gate Function	6-14
Select Corr	2-22 8-8	Time Span	5-12 5-27
Select Marker	3-14	Time Template	12-7 12-31
Select Mask Table	13-6	Title	9-4
Select Temp Table	12-6	title edit screen	11-9
Selecting a Printer	11-4	Top	5-7
Setting Date/Time	9-9	Trace-Time	5-12

Appendix B Keywords Index

Keyword	Page	Keyword	Page
Trace A	5-5	Zone Width	3-4
Trace A on B	5-8		
Trace B	5-6		
Trace Calculate	5-7		
Trace move	5-6		
Trace Time	5-4 5-12		
Tracking	6-13		
Trig Level	6-8		
Trig Slope	6-8		
Trigger Freerun	6-5		
trigger level	6-8 6-11 6-17		
Trigger Mode	6-5		
Trigger Source	5-12		
trigger source	6-6		
Trigger/Gate	6-6		
Triggered	6-6		
TTL	6-8		
U) UNCAL	7-7		
Unit	2-16		
V) V	2-13 2-16 2-17		
VB/RB Ratio	7-5		
VBW	7-8		
Video	6-7		
video filter	5-20		
Video Trigger	6-7		
View	5-16 5-17		
W) W	2-13 2-16 2-17		
Wide IF Video	6-8 12-25		
write protect	10-10		
X) XdBDown mode	12-5		
Z) Zero Span	2-11 5-26		
Zone Marker	3-4		
zone marker	3-25 5-28		
zone marker width	3-4		
Zone→Span	3-25		
Zone Span Point	5-28		
Zone Start Point	5-28		
Zone Sweep	6-12		

Anritsu Service and Sales offices



• Argentina

MULTIRADIO S.A.

Av. Cordoba, 4860 Buenos Aires,
C1414BAT, Argentina
TEL: +55-4779-5522
FAX: +55-4779-5510

• Brazil

ANRITSU ELETRÔNICA LTDA.

Praca Amadeu Amaral, 27-1 andar
01327-010-Paraiso, Sao Paulo, Brazil
TEL: +55-11-3283-2511
FAX: +55-11-2886940

ANRITSU ELETRÔNICA LTDA.

Praia de Botafogo, 440-24 andar-Botafogo
22250-040, Rio de Janeiro, RJ, Brazil
TEL: +55-21-2527-6922
FAX: +55-11-2537-1456

• Canada

ANRITSU ELECTRONICS LTD.

(HEADQUARTERS IN OTTAWA OFFICE)

700 Silver Seven Road, Suite 120, Kanata,
Ontario K2V 1C3, Canada
Toll free: 1-800-ANRITSU (267-4878)
TEL: +1-613-591-2003
FAX: +1-613-591-1006

ANRITSU ELECTRONICS LTD.

(VANCOUVER OFFICE)

300-1055 W Hastings St., Vancouver, BC
V6E 2E9, Canada
Toll free: +1-877-267-4878
TEL: +1-604-682-5933
FAX: +1-604-682-5934

ANRITSU ELECTRONICS LTD.

(TORONTO OFFICE)

2810 Matheson Blvd. E, 2nd Fl.,
Mississauga, ON L4W 4X7, Canada
Toll free: +1-877-267-4878
TEL: +1-905-890-7799
FAX: +1-905-625-5864

• Chile

SISTEMAS DE INSTRUMENTACION LTDA.

Concha y Toro 65, Stgo Centro
Santiago, Chile 51880
TEL: +56-2-6960031
FAX: +56-2-6969665

• Colombia

RENTAMETRIC LTDA.

Calle 24 No. 32-67, Apartado: 23030
Santafe de Bogota, D.C. Colombia
TEL: +57-1-269-6555
FAX: +57-1-269-0191

• Costa Rica

SONIVISION, S.A.

P.O. Box 620-1000, San Jose, Costa Rica
TEL: +506-231-5685
FAX: +506-231-6531

• Ecuador

EQUITRONICS S.A.

Belgica N-32 Hy Av. De Los Shyris,
Edificio IVSEMON PARK, Suite 4B, Quito,
Ecuador
TEL: +593-2-255-396
FAX: +593-2-255-396

• El Salvador

EMPRESA DE COMERCIO EXTERIOR S.A. DE C.V.

Centro Comercial Feria Rosa, Alameda
Dr. Manuel Enrique Araujo, Edificio H,
Local 315 San Salvador, El Salvador
TEL: +503-243-3924
FAX: +503-243-3925

• Guatemala

IMPELSA.

4a Calle 1-15 Zong 10 Guatemala, C.A.
01010, Guatemala
TEL: +502-360-5135
FAX: +502-360-5217

• Mexico

SIHIKATRONICS mmWAVE S.A. DE C.V.

Luz Saviñon 9-701, Col. Del Valle, C.P.
03100, Mexico, D.F., Mexico
TEL: +52-5-5437313
FAX: +52-5-5437317

• Paraguay

DATALAB S.R.L.

Avda. Artigas No 1645 Edificio "DataLab"
Asuncion, Paraguay
TEL: +595-21-20-9126
FAX: +595-21-20-9127

• Peru

ELETELSE S.A.

AV Canaval Moyreya 748, San Isidro,
Lima 27, Peru
TEL: +51-1-224-2514
FAX: +51-1-224-8148

• U.S.A.

ANRITSU COMPANY

1155 East Collins Blvd., Richardson, TX
75081, U.S.A.
Toll Free: +1-800-ANRITSU (267-4878)
TEL: +1-972-644-1777
FAX: +1-972-644-3416

ANRITSU COMPANY

490 Jarvis Drive, Morgan Hill, CA 95037,
U.S.A.
Toll Free: +1-800-ANRITSU (267-4878)
TEL: +1-408-778-2000
FAX: +1-408-778-3180

ANRITSU COMPANY

10 New Maple Ave., Unit 305,

P.O. Box 836, Pine Brook, NJ 07058-0836
U.S.A.

Toll Free: +1-800-ANRITSU (267-4878)

TEL: +1-973-227-8999

FAX: +1-973-575-0092

ANRITSU COMPANY

SALES AND SERVICE, FL OFFICE

312 W. First Street, Suite 300, Sanford,
FL 32771, U.S.A.

Toll Free: 1-800-ANRITSU (267-4878)

TEL: +1-407-321-5130

FAX: +1-407-330-2018

ANRITSU COMPANY

SALES AND SERVICE, GA OFFICE

4625 Alexander Drive, Alpharetta,
GA 30022, U.S.A.

Toll Free: 1-800-ANRITSU (267-4878)

TEL: +1-678-566-0454

FAX: +1-678-566-1776

• Uruguay

CABONORTE S.A.

Colonia 1900, Esc. 603, Montevideo,
Uruguay
TEL: +598-2-430522
FAX: +598-2-418594

• Venezuela

RADIOCOMUNICACIONES CRUZ, C.A.

Calle La Colina Quinta. Elison, Frente al
teatro Alberto Mateo Caracas 1050,
Venezuela

TEL: +58-2-793-2322

FAX: +58-2-793-3429



• Austria

WIEN-SCHALL GmbH

Krichbaumgasse 25, A-1120 Vienna,
Austria

TEL: +43-1-81155140

FAX: +43-1-81155180

• Belgium

ANRITSU GmbH

Grafenberger Allee 54-56, 40237
Düsseldorf, Germany
Local phone: 0800-90001 (toll free)
TEL: +49-211-96855-0
FAX: +49-211-96855-55

• Bulgaria

ELSINCO Representation OFFICE Sofia

h.e. Strelbishte, str. Kottenski Prohod,
bl. 96/6/14, BG-1408 Sofia, Bulgaria

TEL: +359-2-958-1245

FAX: +359-2-958-1698

• **Croatia**

**ELSINCO REPRESENTATION OFFICE
ZAGREB**
Savska 66 HR-10000 Zagreb, Croatia
TEL: +385-1-6312-477
FAX: +385-1-6312-488

• **Czech Republic**

ELSINCO PRAHA SPOL S.R.O.
Novodvorská 994, CZ-142 21 Praha,
4-Branik, Czech Republic
TEL: +420-2-4149-0147
FAX: +420-2-4447-2169

**ELSINCO PRAHA SPOL S.R.O.
(BRNO BRANCH OFFICE)**

Strmá 19, CZ-616 00 Brno, Czech
Republic
TEL: +420-5-4142-7211
FAX: +420-5-4142-7219

• **Denmark**

INSTRUMENTS A/S
Lokesalle 30, DK-8700 Horsens, Denmark
TEL: + 45 75646500
FAX: + 45 75643700

• **Finland**

**ANRITSU AB
(FINLAND BRANCH OFFICE)**
Piispanportti 9, FIN-02240 Espoo, Finland
TEL: +358-9-435-522-0
FAX: +358-9-435-522-50

• **France**

ANRITSU S.A.
9 Avenue du Québec, ZA Courtabœuf 1
91951 LES ULIS CEDEX, France
TEL: +33 1 60 92 15 50
FAX: +33 1 64 46 10 65

**ANRITSU S.A.
(TOULOUSE OFFICE)**
Bureau de Toulouse Région Centre Sud
Ouest, France
TEL: +33-5-62070484
FAX: +33-5-62070668

**ANRITSU S.A.
(TOULON OFFICE)**
Bureau de Toulon Région Centre Sud Est,
France
TEL: +33-4-94040264
FAX: +33-4-94040265

**ANRITSU S.A.
(RENNES OFFICE)**
Bureau de Rennes Région Ouest, France
TEL: +33-2-99521214
FAX: +33-2-99521224

• **Germany**

ANRITSU GmbH
Grafenberger Allee 54-56, 40237
Düsseldorf, Germany
TEL: +49-211-96855-0
FAX: +49-211-96855-55

• **Greece**

KOSTAS KARAYANNIS SA
58 Kapodistriou str, GR-142 35 Nea Ionia,
Athens, Greece
TEL: +30-1-680-0460-4
FAX: +30-1-685-3522

• **Hungary**

ELSINCO BUDAPEST KFT
Pannónia utca 8. IV/l., H-1136 Budapest,
Hungary
TEL: +36-1-339-0000
FAX: +36-1-339-4444

• **Ireland**

PEMA LTD.
Dromiskin, Dundalk, Co. Louth, Ireland
TEL: +353-42-72899
FAX: +353-42-72376

• **Italy**

ANRITSU S.P.A.
Via Elio Vittorini 129, 00144 Roma, Italy
TEL: +39-06-509-9711
FAX: +39-06-502-2425

ANRITSU S.P.A.
Via Paracelso 4, CD Colleoni, Agrate
Brianza, 20041 Milano, Italy
TEL: +39-039-657021
FAX: +39-039-6056396

• **Norway**

BLOMKVIST AS
Pb 188, 1371 ASKER, Norway
TEL: + 47 66901190
FAX: + 47 66901212

• **Poland**

ELSINCO POLSKA SP. Z.O.O
ul Gdanska 50, 01-691 Warszawa, Poland
TEL: +48-22-39-832-4042 (Sat Link)
FAX: +48-22-832-2238

• **Portugal**

OMNITECNICA S.A.
Estrada de Alfragide 23, 2720-015
Amadora, Portugal
TEL: +351-21-472-12-00
FAX: +351-21-472-12-70 (Sales)

• **Slovakia**

ELSINCO SLOVENSKO S.R.O
Kudláková 4, SK-844 15 Bratislava,
Slovakia
TEL: +421 7 6428 41 65
FAX: +421 7 6428 44 54

**ELSINCO SLOVENSKO S.R.O
(KOŠICE BRANCH OFFICE)**
Floriánska 16, SK-043 13 Kosice, Slovakia
TEL: +421 95 62 26 729
FAX: +421 95 62 26 729
CONTACT: Mr. Igor Domorak,
Branch Office Manager

• **Slovenia**

ELSINCO D.O.O.
Dalmatinova 2, SI-1000 Ljubljana,
Slovenia
TEL: +386-61-133-62-77
FAX: +386-61-317-397

• **Sweden**

ANRITSU AB
Botvid Center, Fittja Backe 1-3 S-145
84, Stockholm, Sweden
TEL: +46-8-534-70700
FAX: +46-8-534-70730

• **United Kingdom**

ANRITSU LTD.
200 Capability Green, Luton, Bedfordshire,
LU1 3LU, U.K.
TEL: (Sales) + 44 1582-433280
(Service) +44 1582-433285
FAX: +44 1582-731303



• **Australia**

ANRITSU PTY LTD.
Unit 3/170 Forster Road, Mount. Waverley,
Vic., 3149, Australia
TEL: +61-3-9558-8177
FAX: +61-3-9558-8255

• **Bahrain**

BASMATECH
P. O. Box 5701, Manama, Bahrain
TEL: +973-273729
FAX: +973-725404

• **China**

**ANRITSU COMPANY LTD.
(BEIJING REPRESENTATIVE OFFICE)**
Suite 923, 9/F., Chinachem Golden Plaza
77 Mody Road, Tsimshatsui East,
Kowloon, Hong Kong
TEL: +852-2301-4980
FAX: +852-2301-3545

**ANRITSU COMPANY LTD.
(SHANGHAI OFFICE)**
Room 1807-1810, Tower A CITY CENTER
of Shanghai
No. 100 ZunYi Road 200051 P.R.China
TEL: +86-021-6237-0898
FAX: +86-021-6237-0899